

**COMPAQ SERVICE
QUICK REFERENCE GUIDE**

COMPAQ

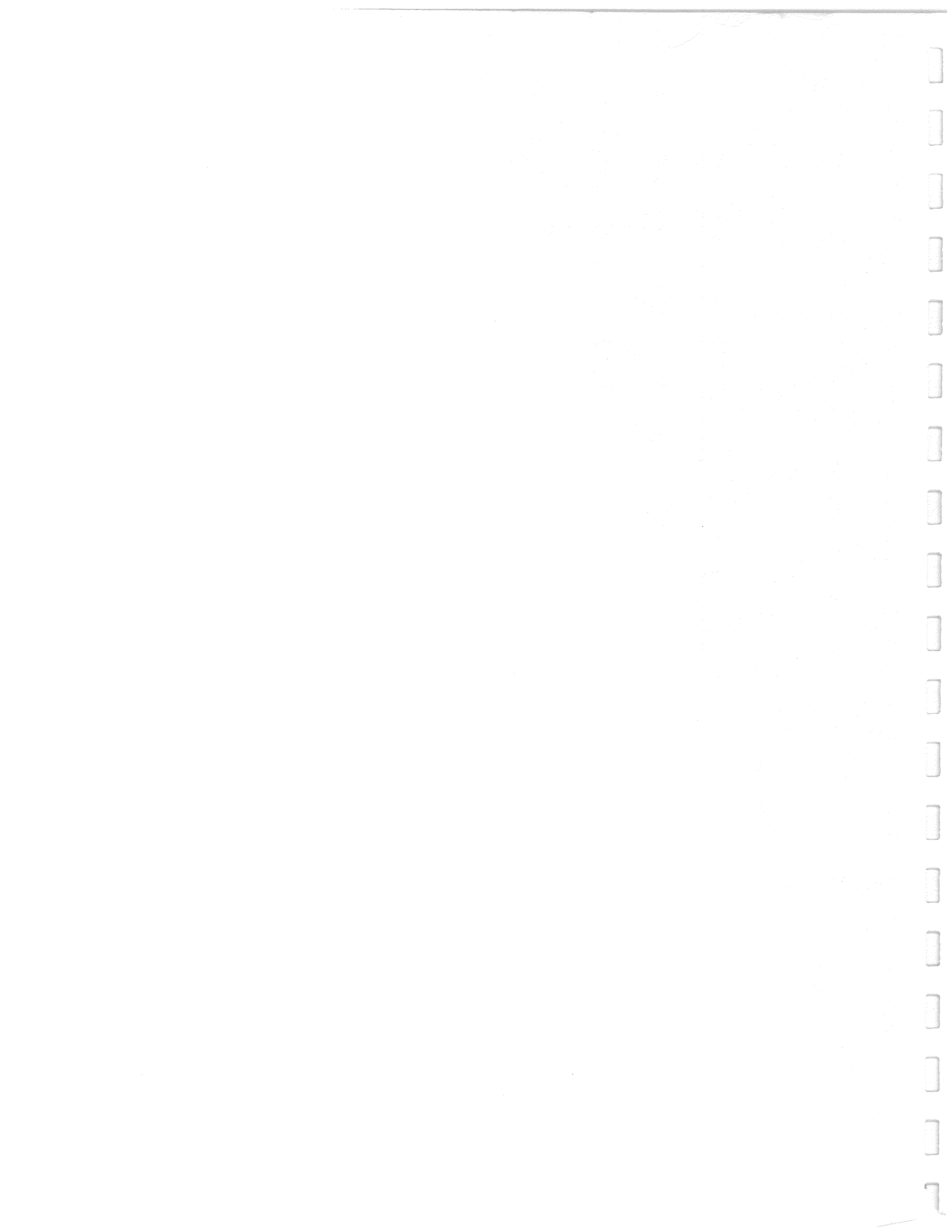

COMPAQ SERVICE QUICK REFERENCE GUIDE

TABLE OF CONTENTS

<u>TITLE</u>	<u>PAGE</u>
Board Index	2
COMPAQ LTE	13
COMPAQ LTE/286	17
COMPAQ LTE 386s/20	21
COMPAQ Portable/COMPAQ PLUS	25
COMPAQ PORTABLE 286	31
COMPAQ PORTABLE II	35
COMPAQ PORTABLE III	41
COMPAQ PORTABLE 386	47
COMPAQ SLT/286	53
COMPAQ SLT 386s/20	57
COMPAQ DESKPRO	61
8-MHz COMPAQ DESKPRO 286	67
12-MHz COMPAQ DESKPRO 286	75
COMPAQ DESKPRO 286e	81
COMPAQ DESKPRO 286N	89
COMPAQ DESKPRO 386	93
COMPAQ DESKPRO 386N	99
COMPAQ DESKPRO 386s	103
COMPAQ DESKPRO 386/20	109
COMPAQ DESKPRO 386/20e	113
COMPAQ DESKPRO 386s/20	119
COMPAQ DESKPRO 386/25	125
COMPAQ DESKPRO 386/25e	131
COMPAQ DESKPRO 386/33	137
COMPAQ DESKPRO 486/25	141
COMPAQ DESKPRO 386/33L & COMPAQ DESKPRO 486/33L	145
COMPAQ SYSTEMPRO	151
COMPAQ Fixed Disk Expansion Units	155
APPENDIX A	
Multiproduct Boards	A-1
Miscellaneous Information	A-11
Software Information	A-15



INDEX MEMORY

BOARD INDEX

MEMORY BOARDS/MODULES (In Assy No. Order)

Board/Module	Assy No.	Spare Part No.	Used In	Page
System Memory	000130	102710-001	DESKPRO 286-8	70
System Memory	000178	102710-001	DESKPRO 286-8	70
512/2048 KB Mem Exp	000307	105033-001	PORTABLE 286	A-1
	000308		PORTABLE II	
			DESKPRO 286-8	
			DESKPRO 286-12	
512/1536 KB Sys Mem	000330	104176-001	PORTABLE II	X*
System Memory	000382	102710-001	DESKPRO 286-8	70
32-Bit System Memory	000413	108059-001	DESKPRO 386	96
1-2 MB 32-Bit Mem Exp	000450	108082-001	DESKPRO 386	96
0.5-2 MB 16-Bit	000458	108138-001	DESKPRO 386	96
4-8 MB 32-Bit Mem Exp	000459	108083-001	DESKPRO 386	96
Memory Expansion	000543	107378-001	PORTABLE III	44
512 KB Memory Module	000576	107687-001	PORTABLE 386	X
1-2 MB Memory Exp	000579	107686-001	PORTABLE 386	X
4 MB Memory Exp	000582	107688-001	PORTABLE 386	X
4 MB Memory Ext	000585	107685-001	PORTABLE 386	X
Expanded Memory	000718	107805-001	PORTABLE III	44
1 MB System Memory	000752	113224-001	DESKPRO 386/20	X
			DESKPRO 386/25	
4 MB Memory Module	000758	113226-001	DESKPRO 286e	X
			DESKPRO 386/20	
			DESKPRO 386/20e	
			DESKPRO 386/25	
			DESKPRO 386/25e	
1 MB Memory Module	000762	113225-001	DESKPRO 286e	X
			DESKPRO 386/20	
			DESKPRO 386/20e	
			DESKPRO 386/25	
			DESKPRO 386/25e	
4 MB System Memory	000765	113222-001	DESKPRO 386/20	X
			DESKPRO 386/25	
1 MB Memory	000857	110357-001	SLT/286	X
4 MB Memory	000863	110863-001	SLT/286	X
1 MB 32-Bit Mem Exp	000960	112518-001	DESKPRO 386/20e	X
			DESKPRO 386/25e	
4 MB 32-Bit Mem Exp	000963	112517-001	DESKPRO 386/20e	X
			DESKPRO 386/25e	
1 MB 16-MHz Mem Exp	000966	112522-001	DESKPRO 386s	X
4 MB 16-MHz Mem Exp	000969	112521-001	DESKPRO 386s	X

* Switch settings on system board must be changed for additional memory.

Continued

INDEX MEMORY

BOARD INDEX

MEMORY BOARDS/MODULES (Cont'd) (In Assy No. Order)

Board/Module	Assy No.	Spare Part No.	Used In	Page
1 MB Memory Module	000981	113225-001	DESKPRO 286e	X
		112519-001	DESKPRO 386s	
		113225-001	DESKPRO 386/20	
		113225-001	DESKPRO 386/20e	
		113225-001	DESKPRO 386/25	
4 MB Memory Module	000993	113225-001	DESKPRO 386/25e	
		113226-001	DESKPRO 286e	X
		112520-001	DESKPRO 386s	
		113226-001	DESKPRO 386/20	
		113226-001	DESKPRO 386/20e	
1 MB Memory Module	001076-001/ 002/003/004/ 005/006/007/ 008	113225-001	DESKPRO 386/20	X
			DESKPRO 386/20e	
			DESKPRO 386/25	
			DESKPRO 386/25e	
			DESKPRO 386s	X
1 MB Memory Module	001076-003/ 004/007/008	112519-001	DESKPRO 386s	X
1 MB System Memory	001103	113224-001	DESKPRO 386/20 DESKPRO 386/25	X
1 MB Memory Module	001151-001	113225-001	DESKPRO 386/20	X
			DESKPRO 386/20e	
			DESKPRO 386/25	
			DESKPRO 386/25e	
1 MB Memory Module	001151-002	112519-001	DESKPRO 386s	X
4 MB Memory Module	001166-001/ 002	113226-001	DESKPRO 286e	X
			DESKPRO 386/20	
			DESKPRO 386/20e	
			DESKPRO 386/25	
4 MB Memory Module	001166-002	112520-001	DESKPRO 386s	X
1 MB 16-Bit Mem Exp	001244	117471-001	DESKPRO 286e	84
4 MB 16-Bit Mem Exp	001247	117470-001	DESKPRO 286e	85
2 MB Single-Socket Memory Module	001250	115184-001	DESKPRO 386/33	X
			SYSTEMPRO	
			DESKPRO 386/33L	
			DESKPRO 486/25	
			DESKPRO 486/33L	
1 MB Memory Module	001256-001/ 002/003/004 005/006/007/ 008	113225-001	DESKPRO 286e	X
			DESKPRO 386/20	
			DESKPRO 386/20e	
			DESKPRO 386/25	
1 MB Memory Module	001256-003/ 004/007/008	112519-001	DESKPRO 386/25e	
			DESKPRO 386s	X

Continued

INDEX MEMORY

BOARD INDEX

MEMORY BOARDS/MODULES (Cont'd) (In Assy No. Order)

Board/Module	Assy No.	Spare Part No.	Used In	Page
1 MB Memory Module	001259-001/ 002	113225-001	DESKPRO 286e DESKPRO 386/20 DESKPRO 386/20e DESKPRO 386/25 DESKPRO 386/25e	X
1 MB Memory Module	001259-002	112519-001	DESKPRO 386s	X
2 MB 32-Bit Sys Mem	001286	115187-001	DESKPRO 386/33	X
Exp Memory Upgrade	001328	117267-001	LTE	X
1 MB Mem	001331-001	117266-001	LTE/286	X
2 MB Mem	001331-002	117265-001	LTE/286	X
4 MB Memory	001331-003	125656-001	LTE/286	X
8 MB Single-Socket Memory Module	001361	116800-001	SYSTEMPRO DESKPRO 386/33L DESKPRO 486/25 DESKPRO 486/33L	X
8 MB Dual-Socket Memory Module	001364	116801-001	SYSTEMPRO DESKPRO 386/33L DESKPRO 486/25 DESKPRO 486/33L	X
32 MB Dual-Socket Memory Module	001367	116802-001	SYSTEMPRO DESKPRO 386/33L DESKPRO 486/25 DESKPRO 486/33L	X
32-Bit, 4-Socket System Memory	001370	116799-001	SYSTEMPRO	X
32-Bit, 6-Socket Memory Expansion	001376	116803-001	SYSTEMPRO DESKPRO 386/33L DESKPRO 486/33L	X
1 MB Memory Module	001385-001	118357-001	SLT 386s/20	X
2 MB Memory Module	001385-002	118356-001	SLT 386s/20	X
4 MB Memory Module	001394	118358-001	SLT 386s/20	X
1 MB Memory	001433	110357-001	SLT/286	X
Memory Expansion	001457	118739-001	DESKPRO 286N DESKPRO 386N DESKPRO 386s/20	X
4 MB 32-Bit Sys Mem	001508	120549-001	DESKPRO 486/25	X
4 MB Memory Module	118665-002	118741-001	DESKPRO 286N DESKPRO 386N DESKPRO 386s/20	X
1 MB Memory Module	118666-001	113911-001	DESKPRO 286N DESKPRO 386N	X
1 MB Memory Module	118666-002	118740-001	DESKPRO 386s/20	X
2 MB Memory Module	118667-002	113923-001	DESKPRO 386N DESKPRO 386s/20	X
1 MB Memory Exp	121127-002	121251-001	LTE 386s/20	X
4 MB Memory Exp	121127-004	121252-001	LTE 386s/20	X

INDEX SYSTEM

BOARD INDEX

SYSTEM BOARDS (In Assy No. Order)

Board	Assy No.	Spare Part No.	Used In	Page
8088 System	000004	100478-001	Portable/PLUS	27
8086 System	000058	101339-001	DESKPRO	63
80286 System	000094	102774-001	DESKPRO 286-8	69
80286 System	000148	101795-001	PORTABLE 286	32
8086 System	000315	105191-001	DESKPRO	63
80286 System	000318	104175-001	PORTABLE II	37
80286 System	000324	104444-001	PORTABLE II	37
80286 System	000361	106434-001	DESKPRO 286-8	69
8086 System	000364	106374-001	DESKPRO	63
8088 System	000383	100478-001	Portable/PLUS	27
386 System	000401	108060-001	DESKPRO 386	95
386 System	000510	107683-001	PORTABLE 386	49
80286 System	000511	107372-001	PORTABLE III	43
80286 System	000512	106707-001	DESKPRO 286-12	77
386 System	000513	108407-001	DESKPRO 386	95
80286 System	000514	106707-001	DESKPRO 286-12	77
80286 System	000515	107372-001	PORTABLE III	43
386 System	000516	113223-001	DESKPRO 386/20	111
80286 System	000517	110355-001	SLT/286	54
386 System	000935	112571-001	DESKPRO 386/20e	115
386 System	000944	115526-001	DESKPRO 386/25	127
386SX System	000954	112572-001	DESKPRO 386s	105
386 System	001056	115526-001	DESKPRO 386/25	127
386 System	001069	115526-001	DESKPRO 386/25	127
386 System	001118	115526-001	DESKPRO 386/25	127
386SX System	001145	112572-001	DESKPRO 386s	105
386SX System	001148	112572-001	DESKPRO 386s	105
386SX System	001157	112572-001	DESKPRO 386s	105
80286 System	001160	110355-001	SLT/286	54
386 System	001184-001	115190-001	DESKPRO 386/33	139
386 System	001184-002	115477-001	DESKPRO 386/33	139
386 System	001196	112571-001	DESKPRO 386/20e	115
80286 System	001226	117469-001	DESKPRO 286e	83
80C86 Sys Processor	001271	117116-001	LTE	X
80C286 Sys Processor	001274	117117-001	LTE/286	X
80C86 System I/O	001277	117118-001	LTE	X
80C286 System I/O	001280	117119-001	LTE/286	X
386 System	001316	112571-001	DESKPRO 386/20e	115
386/33 Sys Processor	001358	116795-001	SYSTEMPRO	X
			DESKPRO 386/33L	
386SX System	001382	118359-001	SLT 386s/20	58
386SX System	001421	122131-001	DESKPRO 386s/20	121
386 System	001427	122078-001	DESKPRO 386/25e	133

Continued

INDEX SYSTEM/STORAGE

BOARD INDEX

15-70-2

SYSTEM BOARDS(Cont'd) (In Assy No. Order)

Board	Assy No.	Spare Part No.	Used In	Page
80286 System	001448	118738-001	DESKPRO 286N	90
486/33 Desktop Proc.	001484	122367-001	DESKPRO 486/33L	X
386SX System	001496	113922-001	DESKPRO 386N	100
386/486 System I/O	001514	116796-001	SYSTEMPRO	153
486 System	001532	120548-001	DESKPRO 486/25	143
386 System	001625	112571-001	DESKPRO 386/20e	116
386/486 System	001632	122368-001	DESKPRO 386/33L	147
			DESKPRO 486/33L	
386SX System	001644	112572-001	DESKPRO 386s	105
486/33 Sys Processor	001738	116794-001	SYSTEMPRO	X
386SX:20 System	001651	121161-001	LTE 386s/20	X

CONTROLLER BOARDS (In Assy No. Order)

Storage Device	Assy No.	Spare Part No.	Used In	Page
Fixed Disk Cntrl	WD1002HX4	101672-001	DESKPRO	63
Fixed Disk Cntrl	WD1002SWX2	101672-001	DESKPRO	63
Fixed Disk Cntrl	WD1002WAH	102778-001	PORTABLE 286	A-1
			DESKPRO 286-8	
			DESKPRO 286-12	
			DESKPRO 386	
Fixed Disk Cntrl	WD1002WX2	101672-001	DESKPRO	63
Fixed Disk Cntrl	WD1003IWH	N/A	PORTABLE II	37
ESDI Fixed Disk (3 1)	WD1005WAH	108140-001	DESKPRO 286-8	A-1
			DESKPRO 286-12	
			DESKPRO 386	
ESDI 130/300	WD1007AWAH	113265-001	DESKPRO 286-8	A-1
			DESKPRO 286-12	
			DESKPRO 386	
			DESKPRO 386/20	
Diskette/Printer	000010	100480-001	Portable/PLUS	X
Diskette/Printer	000043	101341-001	Portable/PLUS	X
			DESKPRO	
Multipurpose Cntrl	000142	102705-001	PORTABLE 286	A-2
			PORTABLE II	
			DESKPRO 286-8	
Multipurpose Cntrl	000181-001	102705-001	PORTABLE 286	A-2
	000181-021		PORTABLE II	
			DESKPRO 286-8	
Diskette/Printer	000181-011	101341-001	Portable/PLUS	A-2
			DESKPRO	
Multipurpose Cntrl	000336	104174-001	PORTABLE II	A-2
			DESKPRO 286-8	
Multipurpose Cntrl	000519	104174-001	PORTABLE II	A-3
			DESKPRO 286-8	

Continued

INDEX STORAGE

BOARD INDEX

CONTROLLER BOARDS (Cont'd) (In Assy No. Order)

Storage Device	Spare Assy No.	Part No.	Used In	Page	
Tape Adapter (135 & 150/250 MB)	000774	113259-001	DESKPRO 286-12	A-3	
			DESKPRO 286e		
			DESKPRO 386		
			DESKPRO 386s		
			DESKPRO 386s/20		
			DESKPRO 386/20		
			DESKPRO 386/20e		
			DESKPRO 386/25		
			DESKPRO 386/25e		
			DESKPRO 386/33		
			SYSTEMPRO		
			DESKPRO 386/33L		
			DESKPRO 486/25		
DESKPRO 486/33L					
Multipurpose Cntrl	000815	104174-001	PORTABLE II	A-3	
			104174-001		DESKPRO 286-8
			113446-001		DESKPRO 286-12
			113446-001		DESKPRO 386
			113446-001		DESKPRO 386/20
Multipurpose Cntrl	000957	115511-001	DESKPRO 386/25	A-3	
Multipurpose ESDI	000996	115519-001	DESKPRO 386/25	128	
ESDI Interface Adapter	001088	115838-001	Expansion Unit	X	
ESDI External 300/600	001091	115839-001	PORTABLE 386	A-3	
			DESKPRO 286-12		
			DESKPRO 286e		
			DESKPRO 386		
			DESKPRO 386s		
			DESKPRO 386/20		
			DESKPRO 386/20e		
			DESKPRO 386/25		
			DESKPRO 286-12		A-4
			DESKPRO 286e		
			DESKPRO 386		
			DESKPRO 386s		
			DESKPRO 386/20		
DESKPRO 386/20e					
DESKPRO 386/25					
DESKPRO 386/33					
ESDI Interface Adapt. II	001313	115191-001	Expansion Unit	X	

Continued

INDEX STORAGE

BOARD INDEX

CONTROLLER BOARDS (Cont'd) (In Assy No. Order)

Storage Device	Spare Assy No.	Part No.	Used In	Page
32-Bit Intelligent Drive Array Controller	001373	116807-001	DESKPRO 386/33L	X
			SYSTEMPRO	
			DESKPRO 486/25	
SCSI Option Adapter	001379	116809-001	DESKPRO 486/33L	A-4
			DESKPRO 386/33	
			DESKPRO 386/33L	
ESDI/Diskette Cntrl	001472	115374-001	SYSTEMPRO	A-4
			DESKPRO 486/25	
			DESKPRO 486/33L	
			DESKPRO 286-12	
			DESKPRO 286e	
			DESKPRO 386	
			DESKPRO 386s	
			DESKPRO 386/20	
			DESKPRO 386/20e	
			DESKPRO 386/25	
Diskette Cntrl	001475	115373-001	DESKPRO 386/33	X
			DESKPRO 286-12	
			DESKPRO 286e	
			DESKPRO 386	
			DESKPRO 386s	
			DESKPRO 386s/20	
			DESKPRO 386/20	
			DESKPRO 386/20e	
			DESKPRO 386/25	
			DESKPRO 386/25e	
15 MHz ESDI Cntrl	001628	115188-001	DESKPRO 386/33	A-4
			DESKPRO 286-12	
			DESKPRO 286e	
			DESKPRO 386	
			DESKPRO 386s	
			DESKPRO 386s/20	
			DESKPRO 386/20	
			DESKPRO 386/20e	
			DESKPRO 386/25	
			DESKPRO 386/25e	
CD-ROM Adapter	001638	110875-001	DESKPRO 386/33	X
			SYSTEMPRO	
			DESKPRO 486/25	
			DESKPRO 486/25	
			DESKPRO 486/33L	
			DESKPRO 486/25	
			DESKPRO 486/33L	
			DESKPRO 486/33L	
			DESKPRO 486/33L	
			DESKPRO 486/33L	
Fixed Disk Cntrl	100637	100644-001	SLT/286	X
			SLT 386s/20	
			PLUS	
32-Bit DualSpeed	114564/	120615-001	SYSTEMPRO	X
			SYSTEMPRO	
Token Ring Cntrl	001397		DESKPRO 386/33L	
			DESKPRO 486/25	
			DESKPRO 486/33L	
Advanced ESDI Cntrl	121699	122370-001	DESKPRO 486/33L	148
			DESKPRO 386/33L	

INDEX VIDEO

BOARD INDEX

VIDEO BOARDS (In Board Type Order)

Video Board	Assy No.	Spare Part No.	Used In	Page
Enh Color Graphics	000410	106373-001	Portable/PLUS	A-5
	000471	109196-001	PORTABLE 286	
			PORTABLE II	
			PORTABLE III	
			PORTABLE 386	
			DESKPRO	
			DESKPRO 286-8	
			DESKPRO 286-12	
			DESKPRO 386	
			DESKPRO 386/20	
Plasma Disp Cntrl	000392	107374-001	PORTABLE III	44
	000932			A-7
Plasma Disp Cntrl	000743	107787-001	PORTABLE 386	X
	000932			A-7
VDU	000007	100479-001	Portable/PLUS	26
VDU	000031	101340-001	Portable/PLUS	A-5
	000160		PORTABLE 286	A-5
	000345		PORTABLE II	A-5
	000525		DESKPRO	A-7
			DESKPRO 286-8	
			DESKPRO 286-12	
			DESKPRO 386	
VGC	000806	109253-001	PORTABLE III	A-7
	001241		PORTABLE 386	
	109360		DESKPRO	
			DESKPRO 286-8	
			DESKPRO 286-12	
			DESKPRO 386	
			DESKPRO 386/20	
			DESKPRO 386/25	
			DESKPRO 386/25	
			DESKPRO 386/25	
Adv Graphics 1024	109958	114201-001	PORTABLE III	A-8
			SLT/286	
			SLT 386s/20	
			DESKPRO 286-12	
			DESKPRO 286e	
			ALL 386-BASED <i>except</i>	
			DESKPRO 386N	
			SYSTEMPRO	
			DESKPRO 486/25	
			DESKPRO 486/33L	
Adv Graphics Memory	109959	114202-001	PORTABLE III	X
			SLT/286	
			SLT 386s/20	
			DESKPRO 286-12	
			DESKPRO 286e	
			ALL 386-BASFD <i>except</i>	
			DESKPRO 386N	
			SYSTEMPRO	
			DESKPRO 486/25	
			DESKPRO 486/33L	

Continued

INDEX

VIDEO/MISC

BOARD INDEX

VIDEO BOARDS (Cont'd) (In Assy No. Order)

Video Board	Assy No.	Spare Part No.	Used In	Page
VGA Pass-Through	001430	114241-001	SLT 386s/20 DESKPRO 286e DESKPRO 386s DESKPRO 386s/20 DESKPRO 386/20e DESKPRO 386/25e DESKPRO 386/33 SYSTEMPRO DESKPRO 486/25	X

MISCELLANEOUS BOARDS (In Assy No. Order)

Miscellaneous	Assy No.	Spare Part No.	Used In	Page
2400 Baud Modem	CEF6CK14373	107791-001	PORTABLE III PORTABLE 386	X
Asynchronous Serial	000016	101095-001	Portable/PLUS	26
Async Comm/Clock	000061	101440-001	Portable/PLUS DESKPRO	A-8
Auto Power Switch	000342	104273-001	PORTABLE II	37
16-Bit Mem/Modem	000549/755	107375-001	PORTABLE III	X
Serial Parallel Interface	000570	106886-001	Portable/PLUS	A-8
	000990		PORTABLE 286 PORTABLE II PORTABLE III PORTABLE 386 ALL DESKTOPS SYSTEMPRO	A-9
32-Bit Mem/Modem	000588	107684-001	PORTABLE 386	X
2nd Serial*	000715		PORTABLE III PORTABLE 386	X
Wetek/387-20	000777	113267-001	DESKPRO 386/20	X
Serial Interface	000854	110360-001	SLT/286 SLT 386s/20	X
2400 Baud Modem	000886	110352-001	SLT/288 SLT 386s/20	X
Extender Connector**	000872	110600-001	SLT/286 SLT 386s/20	X
Backlight Inv	000908	110452-001	SLT/286 SLT 386s/20	X
LED Indicator	000978	110453-001	SLT/286	X

* Available for use outside the U.S. and Canada

** Used in Desktop Expansion Base only

Continued

INDEX MISC

BOARD INDEX

MISCELLANEOUS BOARDS (Cont'd) (In Assy No. Order)

Miscellaneous	Assy No.	Spare Part No.	Used In	Page
2400 Baud Modem	001070	112693-001	PORTABLE II DESKPRO DESKPRO 286-8 DESKPRO 286-12 DESKPRO 286e DESKPRO 286N DESKPRO 386 DESKPRO 386N DESKPRO 386e DESKPRO 386/20 DESKPRO 386s/20 DESKPRO 386/20e DESKPRO 386/25 DESKPRO 386/25e DESKPRO 386/33 SYSTEMPRO DESKPRO 386/33L DESKPRO 486/25 DESKPRO 486/33L	X
2400 Baud Modem	001220	117270-001	LTE LTE/286	X
Serial Interface	001334	117271-001	LTE LTE/286	X
CPU Connector*	001340	110601-001	SLT/286 SLT 386s/20	X
Buffer Board (Exp. Unit)	001409	119194-001	LTE LTE/286	X
Backplane Board	001451	118742-001	DESKPRO 386N DESKPRO 286N	X
LED Indicator	001478	118353-001	SLT 386s/20	X
Enhanced 2400-Baud Internal Modem	001556	118413-001	SLT/286 SLT 386s/20	X
Enhanced 2400-Baud Internal Modem	001559	121969-001	LTE LTE/286	X
Pwr Control Module	001586	121246-001	LTE 386s/20	X
Backlight Inverter	121144	121237-001	LTE 386s/20	X
2400-Baud Int. Modem	001732	121250-001	LTE 386s/20	X
1200 Baud Modem	107041	107376-001	PORTABLE III PORTABLE 386	X
2nd Serial	121173	121240-001	LTE 386s/20	X
Display Module	121175	121418-001	LTE 386s/20	X

* Used in Desktop Expansion Base only

SPARE PARTS CUSTOMER
SPARE PARTS PRICE & COMPATIBILITY LISTING

PRICES EFFECTIVE DECEMBER 10, 1990

NUMERIC ORDER

OPTION PART NUMBER	SPARE PART NUMBER	PART DESCRIPTION	CORD. LINE
	119177-001	HARDWARE KIT, MISCELLANEOUS	
	119178-001	MAINTENANCE & SERVICE GUIDE, COMPACT LITE & LITE/286	
	119180-001	(CD ASSEMBLY)	
	119185-001	TOOL, EXTRACTION (PLCC)	
	119186-001	HARDWARE KIT, MISCELLANEOUS	
	119192-001	CABLE KIT, LED W/LENS	
	119193-001	BOARD, BUFFER (DESKTOP EXPANSION BASE)	
	119194-001	POWER SUPPLY	
	119195-001	PLASTIC S. TOP	
	119196-001	CABLE KIT, MISCELLANEOUS	
	119197-001	CABLE, HOST ADAPTER	
	119198-001	BEZEL, ADAPTER WITH #8 SWITCH	
	119199-001	MONITOR, VIDEO GRAPHICS MONOCHROME (14")	
	119250-001	CABLE, FIXED DISK DRIVE SIGNAL (SINGLE)	
	119546-001	SHIELD, LOWER ACCESS	
	119547-001	SCREWS, 6-32 X 7/16 (50)	
	119548-001	SCREWS, 6-32 X 1/4 (50)	
	119549-001	SCREWS, 8-32 X 5/8 (50)	
	119650-001	SCREWS, 8-32 X 3/8 (50)	
	119852-001	SCREW, PLASTIC 6-19 X 5/8 (50)	
	119853-001	CABLE, LED POWER/MOVE	
	119854-001	WASHERS, #8 EXT TOOTH (100)	
	119882-001	GASKET, EMI SHIELDED	
	120545-001	OPERATIONS GUIDE, COMPACT DESKPRO 486/25	
	120546-001	LOGO KIT	
	120548-001	BOARD, SYSTEM W/INSULATOR	
	120549-001	BOARD, 4-MB 32-BIT SYSTEM MEMORY	
	120576-001	MAINTENANCE & SERVICE GUIDE, SUPPORT SOFTWARE	
	120677-001	MAINTENANCE & SERVICE GUIDE, OPTIONS & PERIPHERALS	
	120578-001	MAINTENANCE & SERVICE GUIDE, COMPACT DESKPRO 486/25	
	120582-001	ROM, SYSTEM (LATEST REVISION)	
	120594-001	CABLE, FIXED DISK DRIVE POWER	
	120588-001	CABLE, FIXED DISK DRIVE POWER (DUAL)	
	120589-001	CABLE, FIXED DISK DRIVE SIGNAL (40-PIN, Y CONNECTOR)	
	120690-001	CABLE, FIXED DISK DRIVE/TAPE POWER	
	120591-001	CABLE, FIXED DISK DRIVE POWER	
	120593-001	CABLE, DISKETTE DRIVE POWER (DUAL)	
	120615-001	CABLE, DISKETTE/TAPE DRIVE SIGNAL	
		BOARD, 32-BIT DUAL-PORTED TOKEN RING CONTROLLER	

OPTION PART NUMBER	SPARE PART NUMBER	PART DESCRIPTION	CORD. LINE	Re Excl	Customer Price	U.S.
						7
						25
						63
						200
						26
						20
						10
						35
						170
						16
						40
						40
						15
						188
						30
						25
						6
						5
						6
						8
						5
						20
						6
						3
						30
						16
						4000
						1650
						21
						21
						21
						60
						15
						15
						20
						10
						16
						10
						20
						844

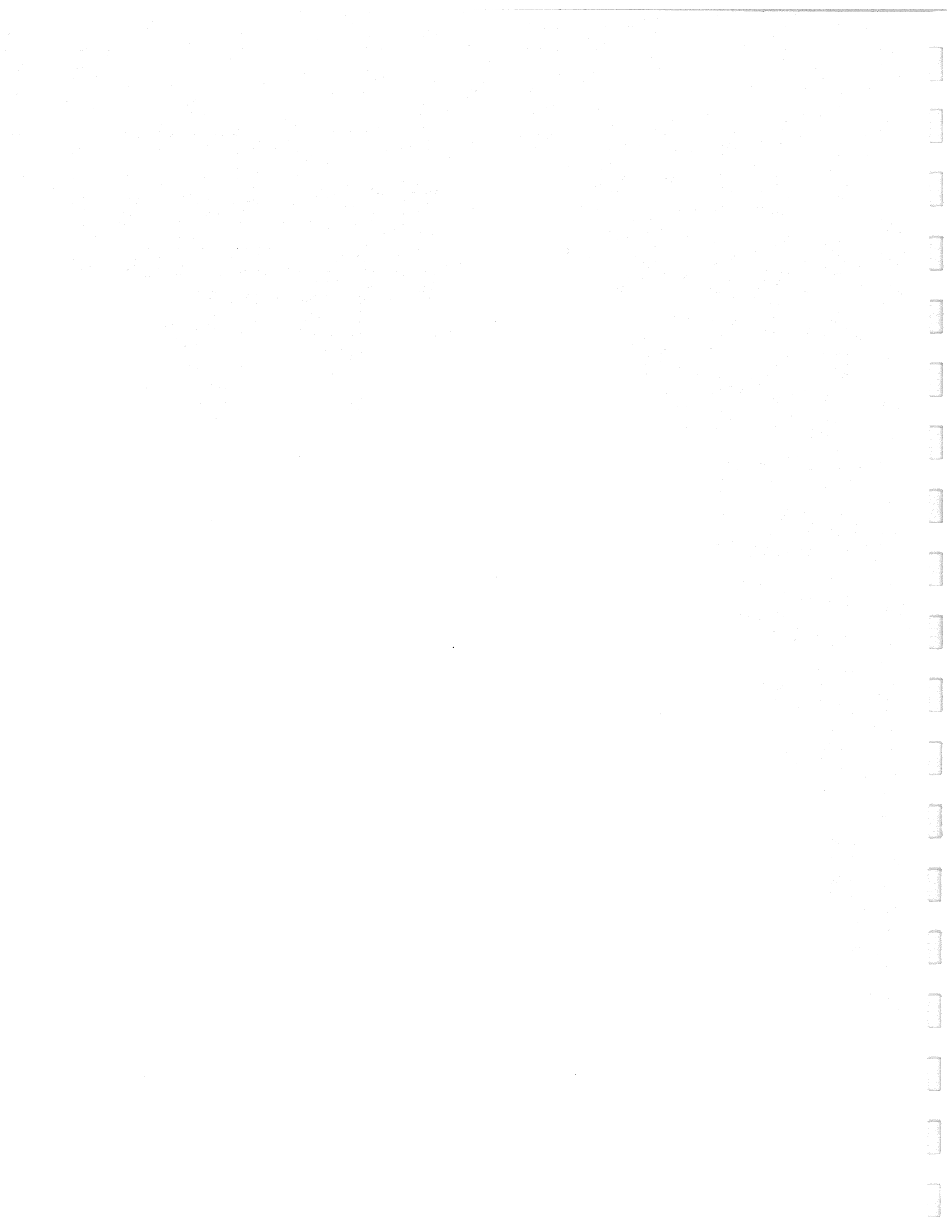

COMPAQ LTE
BOARD COMPATIBILITY LIST

Product	Assy No.	Spare Part No.	Page
---------	----------	----------------	------

SYSTEM BOARDS

80C86 Sys Processor	001271	117116-001	X
---------------------	--------	------------	---

MEMORY BOARDS

Exp. Mem Upgrade	001328	117267-001	X
------------------	--------	------------	---

MISCELLANEOUS INTERNAL

2400-Baud Int Modem	001220	117270-001	X
80C86 System I/O	001277	117118-001	X
Serial Interface	001334	117271-001	X
Enhanced 2400-Baud Internal Modem	001559	121969-001	X

MISCELLANEOUS EXTERNAL

Product	Option Part No.	Spare Part No.
External Storage Module	117079-001	N/A
External Numeric Keypad	117092-001	117263-001
AC Adapter	N/A	117108-001
AC Fast Charger/Adapter	117095-001 (Domestic) 117095-002 (International)	117257-001
Automobile Adapter	117094-001	117289-001
Battery Pack	117229-001	117113-001

FIXED DISK DRIVES

Drive Size	Drive Type	Inter-leave	Inter-grated	Min ROM	Spare Part No.	Controller Assy No.
20 MB	2	1:1	Y	A	117115-001	N/A

TAPE DRIVES

Drive Size	Spare Part No.	Tape Cartridge	Spare Part No.
40/60 MB*	112524-001	40 MB (DC2000)	108142-001
		60 MB	122086-001

*Used in External Storage Module only

DISKETTE DRIVES

Size	Spare Part No.
1.44 MB	117120-001
1.2 MB	112566-001 (Used in External Storage Module only)
360 KB	112587-001 (Used in External Storage Module only)

LTE

COMPAQ LTE

CABLE INFORMATION

Cable Function	Used With	Spare Part No.
Cable Kit*	All	117109-001

*Includes all system cables

JUMPER SETTINGS

External Storage Module

J1 Settings	Function
Flopy	Enables diskette drive
Tape	Enables tape drive

PROCESSOR LOCATION

Processor (80C86) — U11

SYSTEM ROM INFORMATION

System ROM Locations

U4 ODD
U5 EVEN

System ROM Revision (Spare Part No. 117101-001)

Revision	PN on ODD ROM	PN on EVEN ROM
B.1	117062-001	117063-001
C.1	117062-002	117063-002
C.2	117062-003	117063-003
C.3	117062-004	117063-004
C.5	118867-001	118868-001

CLOCK/BATTERY

Spare Part No. 117099-001

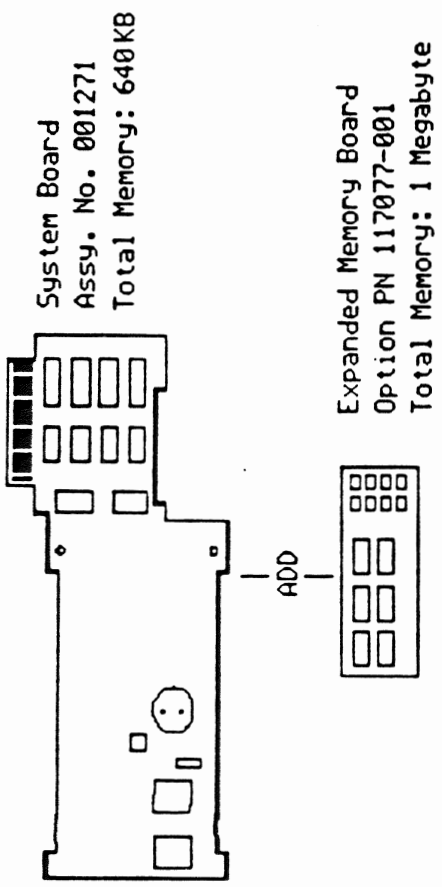

COMPAQ LTE MEMORY UPGRADE CHART

LTE/286

COMPAQ LTE/286 BOARD COMPATIBILITY LIST

Product	Assy No.	Spare Part No.	Page
---------	----------	----------------	------

SYSTEM BOARDS

80C286 Sys Processor	001274	117117-001	X
----------------------	--------	------------	---

MEMORY BOARDS

1 MB Mem	001331-001	117286-001	X
2 MB Mem	001331-002	117265-001	X
4 MB Mem	001331-003	125856-001	X

MISCELLANEOUS INTERNAL

2400-Baud Int Modem	001220	117270-001	X
80C286 System I/O	001280	117119-001	X
Serial Interface	001334	117271-001	X
Enhanced 2400-Baud Internal Modem	001559	121969-001	X

MISCELLANEOUS EXTERNAL

Product	Option Part No.	Spare Part No.
External Storage Module	117079-001	N/A
External Numeric Keypad	117092-001	117263-001
AC Adapter	N/A	117108-001
AC Fast Charger/Adapter	117095-001 (Domestic) 117095-002 (International)	117257-001
Automobile Adapter	117094-001	117289-001
Battery Pack	117229-001	117113-001

FIXED DISK DRIVES

Drive Size	Drive Type	Inter-leave	Inte-grated	Min ROM	Spare Part No.	Controller Assy No.
20 MB	54	1:1	Y	A	117115-001	N/A
40 MB	53	1:1	Y	A	117288-001	N/A

TAPE DRIVES

Drive Size	Spare Part No.	Tape Cartridge	Spare Part No.
40/60 MB*	112524-001	40 MB (DC2000) 60 MB	106142-001 122086-001

*Used in External Storage Module only.

DISKETTE DRIVES

Size	Spare Part No.
1.44 MB	117120-001
1.2 MB	112568-001 (Used in External Storage Module only)
360 KB	112567-001 (Used in External Storage Module only)

LTE/286

COMPAQ LTE/286

CABLE INFORMATION

Cable Function	Used With	Spare Part No.
Cable Kit*	Alt	117109-001

*Includes all system cables

JUMPER SETTINGS

External Storage Module

J1 Settings	Function
F (Disk)	Enables diskette drive
T (Tape)	Enables tape drive

PROCESSOR/COPROCESSOR LOCATIONS

Processor (80C286-12)

U8

Coprocessor (80C287-12) (Spare Part No. 117264-001)

U500

SYSTEM ROM INFORMATION

System ROM Locations

U504 ODD
U503 EVEN

System ROM Revision (Spare Part No. 117100-001)

Revision	PN on ODD ROM	PN on EVEN ROM
A.5	117221-001	117222-001
B.0	117221-002	117222-001
B.1	117221-003	117222-003
B.3	117221-004	117222-004

CLOCK/BATTERY

Spare Part No. 117099-001

System Board
Assy. No. 001274
Total Memory: 640KB

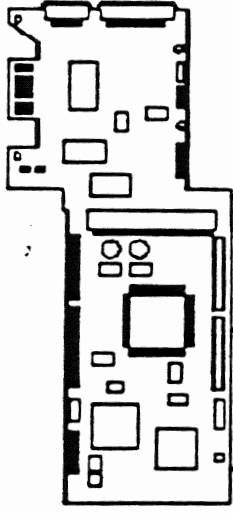

ADD



1 Megabyte Memory
Expansion Board
Option PN 117081-001
Total Memory: 1.6 Megabytes

OR

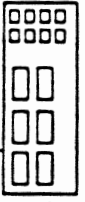

2 Megabyte Memory
Expansion Board
Option PN 117081-002
Total Memory: 2.6 Megabytes

OR

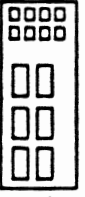

4 Megabyte Memory
Expansion Board
Option PN 117081-003
Total Memory: 4.6 Megabytes

COMPAQ LTE/286 MEMORY UPGRADE CHART

LTE 386s/20

COMPAQ LTE 386s/20 112500-01

BOARD COMPATIBILITY LIST

Product	Assy No.	Spare Part No.	Page
---------	----------	----------------	------

SYSTEM BOARDS

386SX-20 System	001651	121161-001	X
-----------------	--------	------------	---

VIDEO BOARDS

Advanced Graphics 1024*	109958	114201-001	A-8
Advanced Graphics Memory*	109959	114202-001	X

*Used in Desktop Expansion Base only

MEMORY BOARDS

1 MB Mem Exp	121127-002	121251-001	X
4 MB Mem Exp	121127-004	121252-001	X

MISCELLANEOUS INTERNAL

Pwr Cntrl Module	001586	121246-001	X
Backlight Inverter	121148	121237-001	X
2400-Baud Int Modem	001732	121250-001	X
2nd Serial	121173	121240-001	X
Display Module	121175	121418-001	X

MISCELLANEOUS EXTERNAL

Product	Option Part No.	Spare Part No.
External Storage Module	117079-001	N/A
External Numeric Keypad	117092-001	117263-001
AC Charger/Adapter	121288-001	121236-001
Automobile Adapter	121120-001	121422-001
Fast Charger	121126-001	121421-001
Battery Pack	121121-001	121248-001
Desktop Expansion Base	124200-001	N/A
CD-ROM Adapter	124350-001	121467-001

FIXED DISK DRIVES

Drive Size	Drive Type	Inter-leave	Inte-grated	Min ROM	Spare Part No.	Controller Assy No.
30 MB	60	1:1	Y	073090	121245-001	N/A
60 MB	61	1:1	Y	073090	121244-001	N/A

TAPE DRIVES

Drive Size	Spare Part No.	Tape Cartridge	Spare Part No.
40/60 MB*	112524-001	40 MB (DC2000)	108142-001
		60 MB	122086-001
80/120 MB*	122087-001	80 MB	116966-001
		120 MB	116967-001

*Used in External Storage Module only

LTE 386s/20

COMPAQ LTE 386s/20

DISKETTE DRIVES

Size	Spare Part No.
1.44 MB	117120-001
1.2 MB	112566-001 (Used in External Storage Module only)
360 KB	112567-001 (Used in External Storage Module only)

CABLE INFORMATION

Cable Function	Used With	Spare Part No.
Diskette Cable	Diskette Drive	121238-001
FDD LED Cable	Fixed Disk Drive	121420-001
Video Cable	Internal Display	121242-001

JUMPER SETTINGS

External Storage Module

J1 Settings	Function
F (Disk)	Enables diskette drive
T (Tape)	Enables tape drive

PROCESSOR/COPROCESSOR LOCATIONS

Processor (386SX-20)	Coprocessor (80387-20)
U17	U14

SYSTEM ROM INFORMATION

System ROM Location

U19

System ROM Revision (Spare Part No. 121253-001)

Revision	PN on ROM
073090	123854-002

CLOCK/BATTERY

Spare Part No. 117099-001

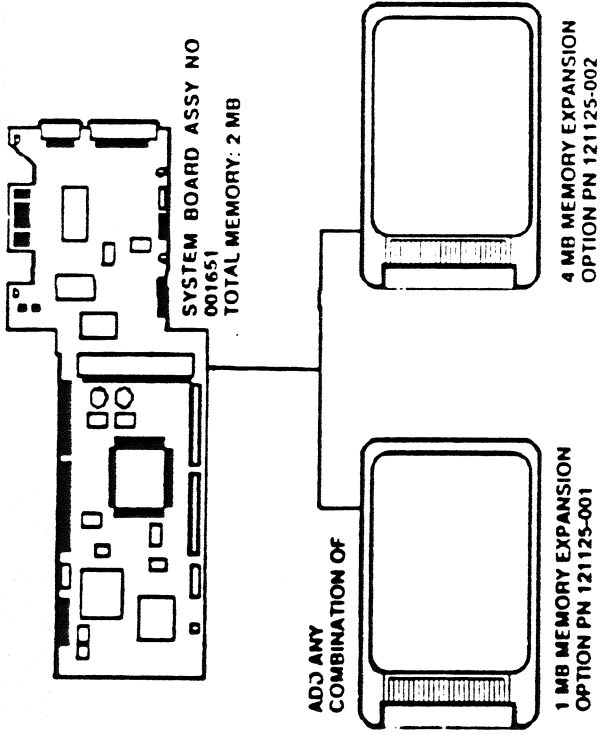

MEMORY EXPANSION ALTERNATIVES

COMPAQ LTE 386s/20 PERSONAL COMPUT		
SYSTEM MEMORY	MEMORY BOARDS ADDED TO SLOT 1	TOTAL MEM
2 MB	1 MB	3 MB
2 MB	1 MB	4 MB
2 MB	1 MB	7 MB
2 MB	4 MB	7 MB
2 MB	4 MB	10 MB

COMPAQ LTE 386s/20 MEMORY UPGRADE CHART

PORT/PLUS

COMPAQ PORTABLE/COMPAQ PLUS

BOARD COMPATIBILITY LIST

Product	Assy No.	Spare Part No.	Page
---------	----------	----------------	------

SYSTEM BOARDS

8068 System	000004/000383	100478-001	27
-------------	---------------	------------	----

MEMORY CHIPS

64 X 1 (150 ns) DRAM		105152-001	X
64 X 4 (150 ns) DRAM		106330-001	X
256 X 1 (150 ns) DRAM		105151-001	X

CONTROLLER BOARDS

Diskette/Printer	000010	100480-001	X
Diskette/Printer	000043	101341-001	X
Diskette/Printer	000181-011	101341-001	A-2
Fixed Disk Cntrl*	100637	100644-001	X

*COMPAQ PLUS only

VIDEO BOARDS

Enh Color Graphics*	000410	106373-001	A-5
Enh Color Graphics*	000471	109196-001	A-5
VDU	000007	100479-001	28
VDU	000031/000160/ 000345	101340-001	A-5
VDU	000525	101340-001	A-7

* Requires minimum system ROM G or later

MISCELLANEOUS

Async Serial	000018	101095-001	26
Async Comm/Clock	000061	101440-001	A-8
Serial/Parallel Interface	000570	106886-001	A-8
Serial/Parallel Interface	000990	106886-001	A-9

PORT/PLUS

COMPAQ PORTABLE/COMPAQ PLUS

FIXED DISK DRIVE

Drive Size	Drive Type	Inter-leave	Inte-grated	Min ROM	Spare Part No.	Controller Assy No.
10 MB*	1	3:1	N	C	100643-001	100637

* Drive type set by switch settings on the fixed disk drive controller board, or by hard wiring on the drive itself, depending on the fixed disk drive controller board.

DISKETTE DRIVE

Size	Spare Part No.
360 KB	101421-001

CABLE INFORMATION

Cable Function	Used With	Spare Part No.
FDD Cable Set	10-MB FDD	100841-001
FDD Signal	10-MB FDD	101601-001 34 Pin
FDD Signal	10-MB FDD	101601-002 20 Pin
Diskette Cable*	Single Drive	100048-002
Diskette Cable*	Dual Drives	100048-004
VDU Signal*	Display	100047-001
Cable Set	Diskette/Display	100512-001

*Included in Cable Kit (PN 100512-001)

BOARD JUMPER/SWITCH SETTINGS

ASYNCHRONOUS SERIAL BOARD (000016)

Jumper	Pin 1 to Pin 2	Pin 2 to Pin 3
J702*	COM2 Address (2FX)	COM1 Address (3FX)
J703*	IRQ3	IRQ4
Shunt	Status	
U11	Pins 5 to 12, 6 to 11, 7 to 10, 8 to 9 connected Serial RS-232C operation	
	Pins 1 to 16, 2 to 15, 3 to 14, 4 to 13 connected 20-mA current loop operation	

*Jumpers J702 & J703 must be changed together

VIDEO DISPLAY CONTROLLER BOARD (000007)

Jumper	Pin 1 to Pin 2	Pin 2 to Pin 3
E4	For monitor requiring negative horizontal sync pulse	For monitor requiring positive horizontal sync pulse (default)
E5	For monitor requiring positive vertical sync pulse (default)	For monitor requiring negative vertical sync pulse

PORT/PLUS

COMPAQ PORTABLE/COMPAQ PLUS

BOARD JUMPER/SWITCH SETTINGS

SYSTEM BOARD (000004 & 000383)
SW1 Settings

1	2	3	4	5	6	7	8	Function
OFF								Reserved (always off)
	ON**							Coprocessor not installed
	OFF							Coprocessor Installed
		OFF	OFF					Reserved (always off)
				OFF	ON			40 X 25 COMPAQ VDU* primary. 3rd-party mono- chrome secondary
				ON**	OFF**			80 X 25 COMPAQ VDU primary. 3rd-party mono- chrome secondary
				ON	ON			COMPAQ EGA, compat- ible EGA, RGBI primary. 3rd-party monochrome secondary
				OFF	OFF			3rd-party monochrome (MDA only) - primary. RGBI - secondary
						ON**	ON**	One diskette drive
						OFF	ON	Two diskette drives
						ON	OFF	Three diskette drives
						OFF	OFF	Four diskette drives

*Applicable with a Rev F or later system ROM

** Default

SW2 Settings***

1	2	3	4	5	6	7	8	Function
ON	OFF	ON	ON	OFF	OFF	OFF	OFF	128 KB total memory
ON	ON	OFF	ON	OFF	OFF	OFF	OFF	192 KB total memory
ON	OFF	OFF	ON	OFF	OFF	OFF	OFF	256 KB total memory
ON	ON	ON	OFF	OFF	OFF	OFF	OFF	320 KB total memory
ON	OFF	ON	OFF	OFF	OFF	OFF	OFF	384 KB total memory
ON	ON	OFF	OFF	OFF	OFF	OFF	OFF	448 KB total memory
ON	OFF	OFF	OFF	OFF	OFF	OFF	OFF	512 KB total memory
OFF	OFF	OFF	OFF	OFF	OFF	OFF	OFF	544 KB total memory

***With a Rev C or later system ROM, SW2 is ignored. Rev C ROM is required to reach 640 KB

PORT/PLUS

COMPAQ PORTABLE/COMPAQ PLUS

PROCESSOR/COPROCESSOR LOCATIONS

Processor (8088)	Coprocessor (8087)
U24 (4.77 MHz)	U13

SYSTEM ROM INFORMATION

SYSTEM ROM LOCATIONS

ROM Location	System Board	ROMs Required
U40 & U47	000004 Rev B	Need 2 ROMs
U40	000004 Rev C or later	Need 1 Rev C or later
U40	000383 All Rev	Need 1 Rev C or later

SYSTEM ROM REVISIONS (Spare Part No. 100699-001)

Rev	PN on ROM
B	100518-001
C	100666-001
E	100298-004
F	100298-005
G	105681-001
H	106265-001
J	106265-002

MEMORY ADDRESS DECODER PROM (For 000004 & 000383 System Boards)

PROM Location	Memory	PN on Chip	Spare PN
U35	256K	100340-001	N/A
U35	448K	101255-001	105417-001
U35	640K	101257-001	105416-001

POWER SUPPLY

Spare Part No. 100475-001

Assy No. 000001-001

BATTERY

Spare Part No. 101260-001 (Mounted on Async Comm/Clock Board)

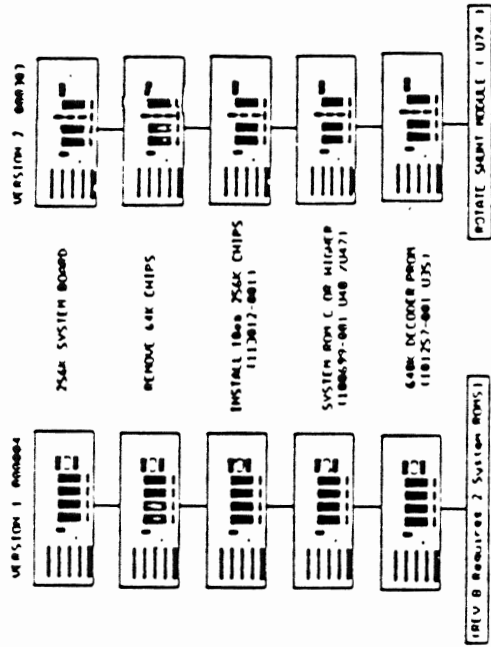

COMPAQ PORTABLE MEMORY UPGRADE CHART

PORT 286

COMPAQ PORTABLE 286

BOARD COMPATIBILITY LIST

<u>Product</u>	<u>Assy No.</u>	<u>Spare Part No.</u>	<u>Page</u>
SYSTEM BOARDS			
80286 System	000148	101795-001	32
MEMORY BOARDS			
512/2048 Mem Exp	000307/000308	105033-001	A-1
MEMORY CHIPS			
256 X 1 (150 ns) DRAM		105151-001	X
CONTROLLER BOARDS			
Fixed Disk Cntrl	WD1002WAH	102778-001	A-1
Multipur Cntrl	000142	102705-001	A-2
Multipur Cntrl	000181-001/021	102705-001	A-2
VIDEO BOARDS			
Enh Color Graphics*	000410	106373-001	A-5
Enh Color Graphics*	000471	109196-001	A-5
VDU	000031/000160/ 000345	101340-001	A-5
VDU	000525	101340-001	A-7
* Requires system ROM F or later			
MISCELLANEOUS			
Serial/Parallel Interface	000570	106886-001	A-8
Serial/Parallel Interface	000990	106886-001	A-9

PORT 286

COMPAQ PORTABLE 286

FIXED DISK DRIVES

Drive Size	Drive Type	Inter-leave	Inte-grated	Min ROM	Spare Part No.	Controller Assy No.
20 MB	2	2:1	N	A	102706-001	WD1002WAH
20 MB	2	2:1	Y	C	104405-001	WD1002WAH

TAPE DRIVE

Drive Size	Spare Part No.	Tape Cartridge	Spare Part No.
10 MB	102779-001	10 MB (DC1000)	101488-001

DISKETTE DRIVES

Size	Spare Part No.
360 KB	102928-001
1.2 MB	102775-001

CABLE INFORMATION

Cable Function	Used With	Spare Part No.	
FDD Signal	All Fixed Disk Drives	101601-001	34 Pin
FDD Signal	All Fixed Disk Drives	101601-002	20 Pin
FDD Cable Set	All Fixed Disk Drives	100641-001	
Monitor Power*	Display	101742-001	
VDU Signal	Display	100047-001	
System Power*	System	101746-001	
Cable Set	All	102933-001	

*Included in Cable Kit (PN 102933-001)

BOARD JUMPER/SWITCH SETTINGS

SYSTEM BOARD (000148)

Jumper	Pins	Function
ED	1 to 2	3rd-party monochrome (MDA only)
ED	2 to 3	COMPAQ VDU, COMPAQ ECG, compatible EGA or RGBI (default)
ES	1 to 2	CPU boot speed 8 MHz (default)
ES	2 to 3	CPU boot speed 6 MHz
EM		Reserved
E1-E3 (MS)	1 to 2	128 KB, 256 KB, or 512 KB*
E1-E3 (MS)	2 to 3	640 KB

*Needs PAL (105045-001) in socket U2 for 512 KB

PORT 286

COMPAQ PORTABLE 286

PROCESSOR/COPROCESSOR LOCATIONS

SYSTEM BOARD (000148)

Processor (80286-8)	U116
Coprocessor (80287-3 or -8)	U122

SYSTEM ROM INFORMATION

SYSTEM ROM LOCATIONS

System Board	ODD ROM Location	EVEN ROM Location
000148	U39	U94

SYSTEM ROM REVISIONS (Spare Part No. 105035-001)

Rev	PN on ODD ROM	PN on EVEN ROM
A	102667-001	102669-001
B	102667-002	102669-002
C	102667-003	102669-003
D	105620-001	105622-001
E	106261-001	106263-001
F	106437-001	106438-001
G	106580-001	106581-001
J	106778-001	106779-001
K	106778-002	106779-002
M	106970-001	106971-001
N.3	106970-002	106971-002
P.1	109739-001	109740-001
R.2	109739-002	109740-002
S.1	109739-003	109740-003

POWER SUPPLY

Spare Part No. 102818-001
Assy No. 000076-001

BATTERY:

Spare Part No. 102929-002

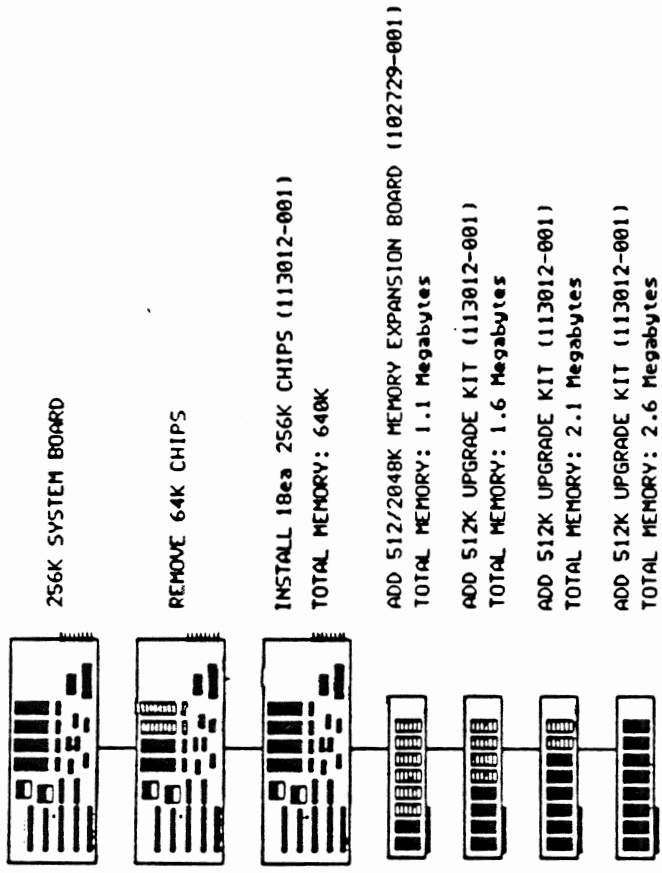

COMPAQ PORTABLE 286 MEMORY UPGRADE CHART

PORT II

COMPAQ PORTABLE II BOARD COMPATIBILITY LIST

Product	Assy No.	Spare Part No.	Page
SYSTEM BOARDS			
80286 System	000318	104175-001	37
80286 System	000324	104444-001	37
MEMORY BOARDS			
512/1536 Sys. Mem	000330	104176-001	X*
512/2048 Mem Exp	000307/000308	105033-001	A-1
* Switch settings on system board must be changed for additional memory			
MEMORY CHIPS			
64 X 1 (150 ns) DRAM		105152-001	X
256 X 1 (150 ns) DRAM		105151-001	X
CONTROLLER BOARDS			
Fixed Disk Cntrl	WD1003IWH	N/A	37
Multipur Cntrl	000142	102705-001	A-2
Multipur Cntrl	000181-001/021	102705-001	A-2
Multipur Fixed Disk	000336	104174-001	A-2
Multipur Fixed Disk	000519/000815	104174-001	A-3
VIDEO BOARDS			
Enh Color Graphics*	000410	106373-001	A-5
Enh Color Graphics*	000471	109196-001	A-5
VDU	000031/000160/ 000345	101340-001	A-5
VDU	000525	101340-001	A-7
*Requires system ROM F or later			
MISCELLANEOUS			
2400-Baud Int Modem	001070	112693-001	X
Serial/Parallel Interface	000570	106886-001	A-8
Serial/Parallel Interface	000690	106886-001	A-9
Auto Pwr Switch	000342	104273-001	37

PORT II

COMPAQ PORTABLE II

FIXED DISK DRIVES

Drive Size	Drive Type	Inter-leave	Inte-grated	Min ROM	Spare Part No.	Controller Assy No.
10 MB	1	2:1	Y	D	104183-001	WD1003IWH* 000338/519/ 815
20 MB	2	2:1	Y	D	104405-001	WD1003IWH 000336/519/ 815

* Provided with Fixed Disk Drive Spares Kit.

DISKETTE DRIVES

Size	Spare Part No.
360 KB	104184-001/107360-001
1.2 MB	104479-001/107359-001
1.44 MB*	109595-001

* Requires system ROM N 3 or later for use with MS-DOS and system ROM P 1 or later for use with MS-DOS/2 Version 1.1. Requires MS-DOS Version 3.31 Revision A if installed as drive B, and MS-DOS Version 3.31 Revision B if installed as drive A.

CABLE INFORMATION

Cable Function	Used With	Spare Part No.
Mass Storage Power	Diskette Drive C	101741-001
Mass Storage Power*	All Diskette Drives	104006-001
Diskette Signal	All Diskette Drives	104008-002
Mass Storage Power	All Fixed Disk Drives	104092-002
FDD Signal*	All Fixed Disk Drives	104093-001
VDU Signal*	Display	104007-001
Cable Kit	All	104191-001

*Included in Cable Kit (PN 104191-001)

PORT II

COMPAQ PORTABLE II

BOARD JUMPER/SWITCH SETTINGS

SYSTEM BOARD (000318 & 000324)

Jumper	Pins	Function
ED	1 to 2	3rd-party monochrome (MDA only)
ED	2 to 3	COMPAQ VDU, COMPAQ EGA, compatible EGA or RGBI (default)
ES	1 to 2	CPU boot speed 8 MHz (default)
ES	2 to 3	CPU boot speed 6 MHz
EM		Reserved

Setting	Function
MS1 = G, MS2 = G	Disable memory and ROM
MS1 = V, MS2 = G	256 KB memory
MS1 = G, MS2 = V	512 KB memory
MS1 = V, MS2 = V	640 KB memory
MS3 = 1.0 or V	1 MB of memory recognized*
MS3 = 1.5 or G	1.5 MB of memory recognized* (default)

* On 512/1536 KB Memory Expansion Board

AUTOMATIC POWER SWITCHING BOARD CONNECTIONS (000342)

Connect 2-pin fan connector to P301 on APS board

Connect 3-pin connector on APS board to J201 on power supply board

Connect 4-pin connector on APS board to J202 on power supply board

FIXED DISK DRIVE CONTROLLER BOARD (WD1003IWH)

Jumper	Pins	Function
W1		Reserved
W2		Reserved
W3	1 - 2	20 Megabyte Fixed Disk Drive
	2 - 3	10 Megabyte Fixed Disk Drive
W4		Reserved

PROCESSOR/COPROCESSOR LOCATIONS

	000318 Sys Bd	000324 Sys Bd
Processor (80286-8)	U100	U69
Coprocessor (80287-3 or -8)	U114	U76

PORT II

COMPAQ PORTABLE II

SYSTEM ROM INFORMATION

SYSTEM ROM LOCATIONS

<u>System Board</u>	<u>ODD ROM Location</u>	<u>EVEN ROM Location</u>
000318	U18	U3
000324	U29	U28

SYSTEM ROM REVISIONS (Spare Part No. 105035-001)

<u>Rev</u>	<u>PN on ODD ROM</u>	<u>PN on EVEN ROM</u>
D	105620-001	105622-001
E	106261-001	106263-001
F	106437-001	106438-001
G	106580-001	106581-001
J	106778-001	106779-001
K	106778-002	106779-002
M	106970-001	106971-001
N.3	106970-002	106971-002
P.1	109739-001	109740-001
R.2	109739-002	109740-002
S.1	109739-003	109740-003

POWER SUPPLY

Spare Part No. 104180-001
Assy No. 000175-002 or 000522-001

BATTERY

Spare Part No. 104186-001

VERSION 1
ASSY NO. 000318

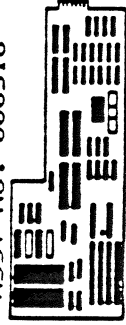

VERSION 2
ASSY NO. 000324



640K

ADD 512/1536-KBYTE
SYSTEM MEMORY BOARD
104221-001

TOTAL MEMORY: 1.1 Megabytes

ADD 512-KBYTE MEMORY UPGRADE KIT

113012-001

TOTAL MEMORY: 1.6 Megabytes

ADD 512-KBYTE MEMORY UPGRADE KIT

113012-001

TOTAL MEMORY: 2.1 Megabytes

ADD 512/2048-KBYTE MEMORY EXPANSION BOARD

102729-001

TOTAL MEMORY: 2.6 Megabytes

ADD 512-KBYTE MEMORY UPGRADE KIT

113012-001

TOTAL MEMORY: 3.1 Megabytes

ADD 512-KBYTE MEMORY UPGRADE KIT

113012-001

TOTAL MEMORY: 3.6 Megabytes

ADD 512-KBYTE MEMORY UPGRADE KIT

113012-001

TOTAL MEMORY: 4.1 Megabytes

COMPAQ PORTABLE II MEMORY UPGRADE CHART

PORT III

COMPAQ PORTABLE III BOARD COMPATIBILITY LIST

Product	Assy No.	Spare Part No.	Page
---------	----------	----------------	------

SYSTEM BOARDS

80286 System	000540/000709	107372-001	43/44
--------------	---------------	------------	-------

MEMORY BOARDS

Expanded Memory	000718	107805-001	44
Memory Expansion	000543	107378-001	44

MEMORY MODULES

256 X 9 SIMM		107380-001	X
1 MB X 9 SIMM		107379-001	X

VIDEO BOARDS

Enh Color Graph*	000410	106373-001	A-5
Enh Color Graph*	000471	109196-001	A-5
Plasma Display	000392	107374-001	44
	000932		A-7
VGC*	000806/001241/ 109360	109253-001	A-7
Advanced Graphics 1024	109958	114201-001	A-8
Advanced Graphics Memory	109959	114202-001	X

*ECG and VGC require system ROM K or later

MISCELLANEOUS

2nd Serial*	000715		X
16-Bit Mem/Modem	000549/000755	107375-001	X
1200-Baud Int. Modem	107041	107376-001	X
2400-Baud Int. Modem	CEF6CK14373	107791-001	X
Serial/Parallel Interface	000570	106886-001	A-8
Serial/Parallel Interface	000990	106886-001	A-9

*Available for use outside of the U.S. and Canada

PORT III

COMPAQ PORTABLE III

FIXED DISK DRIVES

Drive Size	Drive Type	Inter-leave	Inte-grated	Min ROM	Spare Part No.	Controller Assy No.
20 MB	2	1:1	Y	K	107890-001	N/A
20 MB	2	3:1	Y	K	107358-001	N/A
40 MB	17	3:1	Y	K	107357-001	N/A
40 MB*	43	1:1	Y	P	114106-001	N/A

* Requires MS-DOS 3.2 or later

TAPE DRIVE

Drive Size	Spare Part No.	Tape Cartridge	Spare Part No.
40 MB*	107785-001	40 MB (DC2000)	108142-001

*Used in Expansion Unit only

DISKETTE DRIVES

Size	Spare Part No.
360 KB	107360-001
1.2 MB	107359-001
1.44 MB*	109595-001

*Requires system ROM N 2 or later for use with MS-DOS and system ROM P 2 or later for use with MS-DOS/2 Version 1.1. Requires MS-DOS Version 3.31 Revision A if installed as drive B and MS-DOS Version 3.31 Revision B if installed as drive A.

CABLE INFORMATION

Cable Function	Used With	Spare Part No.
Mass Storage Power	Fixed Disk Drive Drive C	101741-001 6 in.
Mass Storage Power	Fixed Disk Drive Drive D	101741-004 15 in.
FDD Signal	All Fixed Disk Drives	107176-001
Diskette Signal	All Diskette Drives Single Drive	107177-001
Diskette Signal	All Diskette Drives Dual Drives	107177-002
Display Data	Display	107171-001
Display Controller	Display	107173-001
Display Intensity	Display	107174-001
Display Power	Display	107175-001
RGB Port	Display	107172-001
Modem Jack	Modem (RJ11 to RJ11)	107518-001
Cable Kit	All	107382-001

PORT III

COMPAQ PORTABLE III

BOARD JUMPER/SWITCH SETTINGS

SYSTEM BOARD (000540 & 000709)

Jumper Settings*	Function
E1-1 to E1-2**	CPU speed 12 or 8 MHz when accessing diskette drive
E1-2 to E1-3	CPU speed 8 MHz when accessing diskette drive
E2	Reserved - No jumper installed
E3-1 to E3-2**	Serial device COM1
E5-2 to E16-2	IRQ4
E3-2 to E4-2	Serial device COM2
E5-1 to E5-2	IRQ3
E3-1 to E4-1	Modem for COM1
E16-1 to E16-2	IRQ4
E4-1 to E4-2**	Modem for COM2
E5-1 to E16-1	IRQ3
E7-2 to E7-3**	Enable parallel interface
E7-1 to E7-2	Disable parallel interface
E8-1 to E8-2**	Diskette drive primary address
E8-2 to E8-3	Diskette drive secondary address
E8-4 to E8-5**	Fixed disk drive primary address
E8-5 to E8-6	Fixed disk drive secondary address
E10-1 to E10-2	16-KB ROM
E10-2 to E10-3**	32-KB ROM
E12-1 to E12-2	Enable ROM set 2
E12-2 to E12-3**	Disable ROM set 2
E17-2 to E17-3** &	No extended memory when using the expanded
E17-4 to E17-5	memory board
E17-2 to E17-3 &	Address bank 1 (extended memory)
E17-5 to E17-6	(J201 and J202)
E17-1 to E17-2 &	Address bank 1 & 2 (extended memory)
E17-4 to E17-5	(J201 through J204)
E17-1 to E17-2 &	Address banks 1, 2, & 3 (extended memory)
E17-5 to E17-6	(J201 through J206)

* If another serial device or a third-party modem is used, the jumpers for that device's address must be removed

** Default

Continued

PORT III

COMPAQ PORTABLE III

BOARD JUMPER/SWITCH SETTINGS

SYSTEM BOARD (000540 & 000709)

SW1 Settings

1	2	3	4	5	6	7	8	Function
ON	ON							Reserved
ON	OFF							0-256 KB
OFF	ON							0-512 KB
OFF*	OFF*							0-640 KB
		ON*	OFF*					Select 256KB X 9 DRAM module for expansion memory
		OFF	ON					Select 1MB X 9 DRAM module for expansion memory
		OFF	OFF					Reserved
		ON	ON					Reserved
				ON*				Enable fixed disk drive
				OFF				Disable fixed disk drive
					ON			CPU boot speed 8 MHz
					OFF*			CPU boot speed 12 MHz
						ON*		Plasma display in CGA mode
						OFF		Plasma display in monochrome mode
							OFF	Reserved

*Default

EXPANDED MEMORY BOARD (000718)

Jumper	Function
E1 1-2	256-KB modules installed (default)
E2 1-2	
E1 2-3	1-MB modules installed
E2 2-3	

MEMORY EXPANSION BOARD (000543)

Jumper	Function
1-2	256-KB modules installed (default)
2-3	1-MB modules installed

PLASMA DISPLAY CONTROLLER BOARD (000392)

Jumper E1	Function
1-2	Primary Address 3XXX (default)
2-3	Secondary Address 2XXX

PORT III

COMPAQ PORTABLE III

PROCESSOR/COPROCESSOR LOCATIONS

PROCESSOR (80286-12)	COPROCESSOR (80287-8)
U52	U43

SYSTEM ROM INFORMATION

SYSTEM ROM LOCATIONS

U72 ODD
U89 EVEN

SYSTEM ROM REVISIONS (Spare Part No. 107592-001)

Rev	PN on ODD ROM	PN on EVEN ROM	Size
K	106778-002	106779-002	16 Kbyte
N 2	107824-001	107825-001	32 Kbyte
P.2	109737-001	109738-001	32 Kbyte
R 2	109737-002	109738-002	32 Kbyte

POWER SUPPLY

Spare Part No. 107373-001

BATTERY

Spare Part No. 107385-001 (For System Board 000709-001)

BATTERY/CLOCK MODULE

Spare Part No. 107872-001 (For System Board 000709-003)



SYSTEM BOARD
TOTAL MEMORY: 642K

ADD 16-BIT MEMORY/NOEXM
INTERFACE BOARD (1187989-001)

ADD EITHER 2-Megabyte MEMORY BOARD (1187911-001)
OR 4-Megabyte MEMORY BOARD (1187912-001)
EXPANDED MEMORY

ADD 512 Kbyte MEMORY OPTION KIT
(1187331-001)

TOTAL MEMORY: 1.1 Megabytes

ADD 512 Kbyte MEMORY OPTION KIT
(1187331-001)

TOTAL MEMORY: 1.6 Megabytes

ADD 512 Kbyte MEMORY OPTION KIT
(1187331-001)

TOTAL MEMORY: 2.1 Megabytes

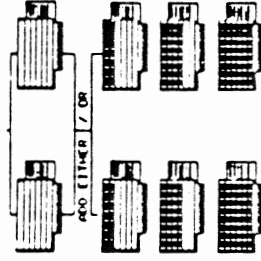

ADD 2-Megabyte MEMORY OPTION KIT
(1187332-001)

TOTAL MEMORY: 2.6 Megabytes

ADD 2-Megabyte MEMORY OPTION KIT
(1187332-001)

TOTAL MEMORY: 4.6 Megabytes

ADD 2-Megabyte MEMORY OPTION KIT
(1187332-001)

TOTAL MEMORY: 6.6 Megabytes

COMPAQ PORTABLE III MEMORY UPGRADE CHART

PORT 386

COMPAQ PORTABLE 386

BOARD COMPATIBILITY LIST

Product	Assy No.	Spare Part No.	Page
SYSTEM BOARDS			
80386 System	000510	107683-001	49-51
MEMORY BOARDS/MODULES			
1-2 MB Mem Exp	000579	107686-001	X
4 MB Mem Exp	000582	107688-001	X
4 MB Mem Ext	000585	107685-001	X
512 KB SIMM	000576	107687-001	X
CONTROLLER BOARDS			
ESDI External	001091	115839-001	A-3
VIDEO BOARDS			
Enh Color Graphics*	000410	106373-001	A-5
Enh Color Graphics*	000471	109196-001	A-5
Plasma Display	000743	107787-001	X
	000932		A-7
VGC* **	000806/001241/ 109360	109253-001	A-7
Advanced Graphics** 1024	109958	114201-001	A-8
Advanced Graphics** Memory	109959	104202-001	X
* ECG and VGC require system ROM H or later			
** Installed in Expansion Unit only			
MISCELLANEOUS			
2nd Serial*	000715	N/A	X
32-Bit Mem/Modem	000588	107684-001	X
1200-Baud Int Modem	107041	107376-001	X
2400-Baud Int Modem	CEF6CK14373	107791-001	X
Serial/Parallel Interface	000570	106886-001	A-8
Serial/Parallel Interface	000990	106886-001	A-9
*Available outside of the U S and Canada			

PORT 386

COMPAQ PORTABLE 386

BOARD JUMPER/SWITCH SETTINGS

SYSTEM BOARD (000510)

<u>Jumper</u>	<u>Function</u>
INTERNAL SERIAL INTERFACE	
E3 2 to 3	
E4 1 to 2	Serial interface as COM1 (3FX, IRQ4)
E8 1 to 2	& modem or 2nd serial interface
E8 3 to 4	as COM2 (2FX, IRQ3) (default)
E9 1 to 3	
E9 2 to 4	
E3 2 to 3	
E4 1 to 2	Serial interface as COM2 (2FX, IRQ3)
E8 1 to 3	& modem or 2nd serial interface
E8 2 to 4	as COM1 (3FX, IRQ4)
E9 1 to 2	
E9 3 to 4	
E3 2 to 3	
E4 2 to 3	
E8 1 to 2	Serial interface as COM1 (3FX, IRQ4),
E8 3 to 4	disable internal COM2
E9 1 to 3	
E9 2 to 4	
E3 1 to 2	
E4 2 to 3	
E8 1 to 2	Serial interface as COM2 (2FX, IRQ3),
E8 3 to 4	disable internal COM1
E9 1 to 2	
E9 3 to 4	
E3 2 to 3	
E4 2 to 3	Modem or 2nd serial interface
E8 1 to 3	as COM1 (3FX, IRQ4),
E8 2 to 4	disable internal COM2
E9 1 to 2	
E9 3 to 4	
E3 1 to 2	
E4 2 to 3	Modem or 2nd serial interface
E8 1 to 3	as COM2 (2FX, IRQ3),
E8 2 to 4	disable internal COM1
E9 1 to 3	
E9 2 to 4	
E3 1 to 2	
E4 1 to 2	
E8 1 to 2	Disable both internal serial interfaces
E8 3 to 4	
E9 1 to 3	
E9 2 to 4	

Continued

PORT 386:

COMPAQ PORTABLE 386

FIXED DISK DRIVES

Drive Size	Drive Type	Inter-leave	Inte-grated	Min ROM	Spare Part No.	Controller Assy No.
40 MB	17	3:1	Y	H.2	107357-001	N/A
40 MB ¹	43	1:1	Y	J	114106-001	N/A
100 MB	45	3:1	Y	H.2	107790-001	N/A
110 MB ¹	33	1:1	Y	K	107982-001	N/A
300 MB ²	38	1:1	N	K	113219-001	001091

¹ Requires MS-DOS 3.2 or later

² Used in External Fixed Disk Drive Expansion Unit. Requires MS-DOS 3.3 or later.

TAPE DRIVE

Drive Size	Spare Part No.	Tape Cartridge	Spare Part No.
40 MB*	107785-001	40 MB (DC2000)	108142-001

*Used in Expansion Unit only

DISKETTE DRIVES

Size	Spare Part No.
360 KB	107360-001
1.2 MB	107359-001
1.44 MB*	109595-001

*Requires system ROM J 2 or later for use with MS-DOS and system ROM J 4 or later for use with MS OS/2 Version 1.1. Requires MS-DOS Version 3.31 Revision A if installed as drive B, and MS-DOS Version 3.31 Revision B if installed as drive A.

CABLE INFORMATION

Cable Function	Used With	Spare Part No.
Mass Storage Power	Internal Fixed Disk Drives	101741-003
Mass Storage Power	Fixed Disk Drives (Drive D)	101741-004
FDD Signal	Internal Fixed Disk Drives	107798-001
Diskette Controller	All Diskette Drives (Single Drive)	107177-001
Diskette Controller	All Diskette Drives (Dual Drives)	107177-002
Display Data	Display	107171-001
Display Control	Display	107173-001
Display Intensity	Display	107174-001
Display Power	Display	107175-001
RGB Port	Display	107172-001
Modem Jack	Modem (RJ11 - RJ11)	107518-001
Cable Kit		107382-001

PORT 386

COMPAQ PORTABLE 386

BOARD JUMPER/SWITCH SETTINGS

SYSTEM BOARD (000510)

Jumper	Function
MASS STORAGE DEVICES	
E5 1 to 2	Enable fixed disk drive (default)
E5 2 to 3	Disable fixed disk drive
E6 2 to 3	Diskette drive primary address (default)
E6 1 to 2	Diskette drive secondary address
TOTAL 32-BIT MEMORY INSTALLED	
E15 1 to 2	1 Megabyte (default)
E16 1 to 2	
E17 1 to 2	
E15 2 to 3	2 Megabyte
E16 1 to 2	
E17 1 to 2	
E15 1 to 2	3 Megabyte
E16 2 to 3	
E17 1 to 2	
E15 2 to 3	4 Megabyte
E16 2 to 3	
E17 1 to 2	
E15 1 to 2	6 Megabyte
E16 2 to 3	
E17 2 to 3	
E15 2 to 3	10 Megabyte
E16 2 to 3	
E17 2 to 3	
32-BIT MEMORY USED AS BASE MEMORY	
E13 1 to 2 & E14 1 to 2	640 Kbyte (default)
E13 1 to 2 & E14 2 to 3	512 Kbyte
E13 2 to 3 & E14 2 to 3	256 Kbyte
INTERNAL PARALLEL PRINTER INTERFACE	
E1 2 to 3 & E2 1 to 2	LPT1 (default)
E1 1 to 2 & E2 2 to 3	LPT2
E1 1 to 2 & E2 1 to 2	LPT3
E1 2 to 3 & E2 2 to 3	Disable interface
E7 1 to 2	Primary Interrupt (IRQ7) (default)
E7 2 to 3	Alternate Interrupt (IRQ5)

Continued

PORT 386

COMPAQ PORTABLE 386

BOARD JUMPER/SWITCH SETTINGS

SYSTEM BOARD (000510)

Jumper	Function
MISCELLANEOUS	
E20 1 to 2	387 coprocessor installed or Weitek 3167 coprocessor not installed
E20 2 to 3	387 coprocessor not installed or Weitek 3167 coprocessor installed (default)
E21 1 to 2	CPU boot speed 20 MHz except when accessing diskette drive, then 8 MHz (default)
E21 2 to 3	CPU boot speed 20 MHz (always)
E23 1 to 2	COMPAQ Plasma Display in CGA mode (default)
E23 2 to 3	COMPAQ Plasma Display in monochrome mode
E12 1 to 2	Reserved
E18 2 to 3	Reserved
E19 1 to 2	Reserved
E22 2 to 3	Reserved
E24 1 to 2	Reserved
E25 1 to 2	Reserved

PROCESSOR/COPROCESSOR LOCATIONS

PROCESSOR (386-20) COPROCESSOR (387-20/Weitek 3167)

U62 U69

SYSTEM ROM INFORMATION

SYSTEM ROM LOCATIONS

U32 ODD U40 EVEN

SYSTEM ROM REVISION (Spare Part No. 107796-001)

Rev	PN on ODD ROM	PN on EVEN ROM
H.2	107733-003	107734-003
J.4	109593-001	109594-001
K.3	109593-002	109594-002

POWER SUPPLY

Spare Part No. 107373-001

BATTERY

Spare Part No. 107786-001

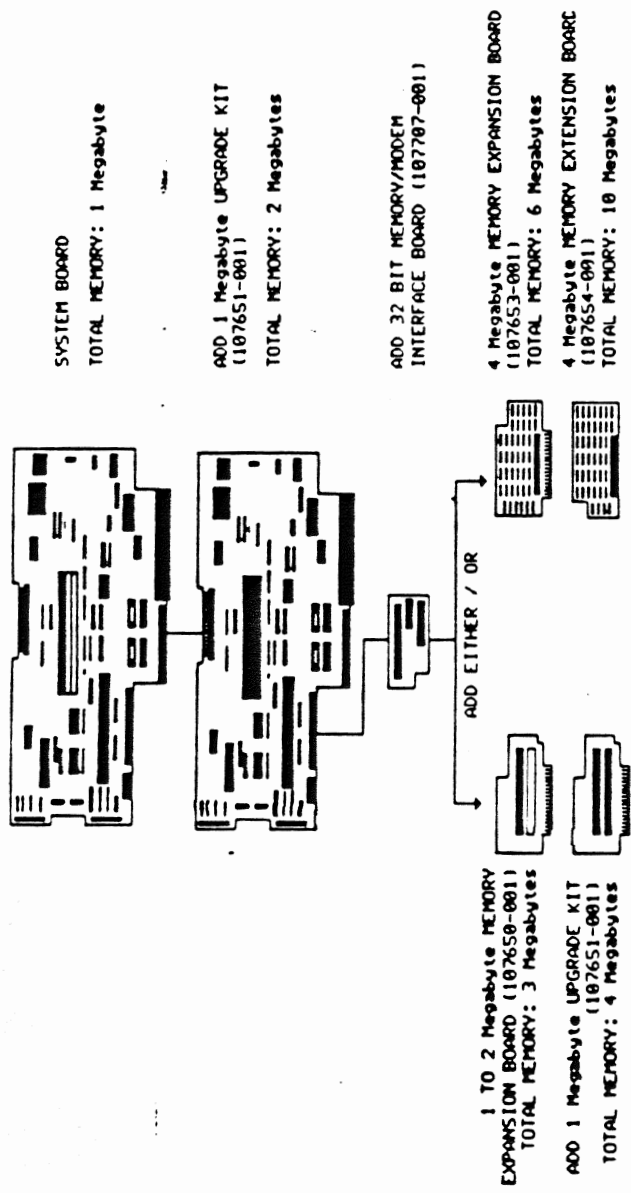

COMPAQ PORTABLE 386 MEMORY UPGRADE CHART

SLT/286

COMPAQ SLT/286

COMPATIBILITY LIST

Product	Assy No.	Spare Part No.	Page
---------	----------	----------------	------

SYSTEM BOARDS

80286 System	000851	110355-001	54
80286 System	001160*	110355-001	54

* Comes with Memory Module (Assy No. 001163) mounted on system board.

MEMORY BOARDS

1 MB Memory	000857	110357-001	X
4 MB Memory	000863	110863-001	X

MISCELLANEOUS INTERNAL

2400-Baud Int Modem	000866	110352-001	X
Serial Interface	000854	110360-001	X
Backlight Invt	000908	110452-001	X
LED Indicator	000978	110453-001	X
Extender Connector*	000872	110600-001	X
CPU Connector*	001340	110601-001	X
Enhanced 2400-Baud Internal Modem	001556	118413-001	X
Advanced Graphics 1024*	109958	114201-001	A-8
Advanced Graphics Memory	109959	114202-001	X
CD-ROM Adapter	001638	110875-001	X

* Used in Desktop Expansion Base only

MISCELLANEOUS EXTERNAL

Product	Option Part No.	Spare Part No.
External Numeric Keypad	110052-001	110454-001
Desktop Expansion Base	110059-001	N/A
Battery Pack	110287-001	110351-001
Automobile Adapter	110288-001	110708-001
External Battery Charger	110700-001	110708-001
External Storage Module	110281-001	N/A
AC Adapter	N/A	110353-001

SLT/286

COMPAQ SLT/286

COMPATIBILITY LIST

FIXED DISK DRIVES

Drive Size	Drive Type	Inter-leave	Inte-grated	Min ROM	Spare Part No.	Controller Assy No.
20 MB	2	1:1	Y	F.2	110570-001	N/A
20 MB	2	3:1	Y	F.2	110359-001	N/A
40 MB	22	1:1	Y	F.2	110358-001	N/A

TAPE DRIVE

Drive Size	Spare Part No.	Tape Cartridge	Spare Part No.
40/60 MB*	112524-001	40 MB (DC2000)	108142-001
		60 MB	122086-001

*Used in External Storage Module only.

DISKETTE DRIVES

Size	Spare Part No.
1.2 MB	112566-001 (Used in External Storage Module only.)
360 KB	112567-001 (Used in External Storage Module only.)
1.44 MB	110356-001

CABLE INFORMATION

Cable Function	Used With	Spare Part No.
Mass Storage Power	All FDD	110007-001
FDD Signal	All FDD	110008-001
Diskette Power/Signal	Internal Diskette	110005-001
Signal Cable	Ext Storage Module	110268-001
Power Cable	Ext Storage Module	110270-001
Ground Cable	Display	110503-001
Power Cord	AC Adapter	110543-001
Telephone Cable	Modem	112666-001
Cable Kit (4 Cables)		110551-001
Cable Kit (2 Cables)		110553-001

BOARD JUMPER/SWITCH SETTINGS

System Board (000851 & 001160)*

J1 Settings	Function
1 to 2	8-MHz 80287
2 to 3	12-MHz 80C287

*Jumpers E2, E3, and E4 reserved. These jumpers must be installed for proper board operation.

SLT/286

COMPAQ SLT/286

JUMPER/SWITCH SETTINGS (Cont'd)

External Storage Module

Jumper	Function
F1py	Enables diskette drive
Tape	Enables tape drive

PROCESSOR/COPROCESSOR LOCATIONS

Processor (80C286-12)	Coprocessor (80287-8 or 80C287-12)
U31	U45

SYSTEM ROM INFORMATION

System Rom Locations

U56 ODD
U57 EVEN

System Rom Revision (Spare Part No. 110542-001)

Rev	PN on ODD ROM	PN on EVEN ROM
F.2	110091-002	110092-002
F.5	110091-003	110092-003
G.2	110091-005	110092-005
H.1	110091-006	110092-006
H.2	110091-007	110092-007
H.3	110091-008	110092-008
H.4	110091-009	110092-009
H.5	110091-010	110092-010
H.6	110091-011	110092-011
H.7	110091-012	110092-012
J.1	110091-013	110092-013
J.2	110091-014	110092-014

POWER SUPPLIES

AC Adapter Power Supply	DC Internal Power Supply
Spare Part No. 110353-001	Spare Part No. 110361-001

Desktop Expansion Base Power Supply
Spare Part No. 110599-001

External Storage Module Power Supply
Spare Part No. 110448-001

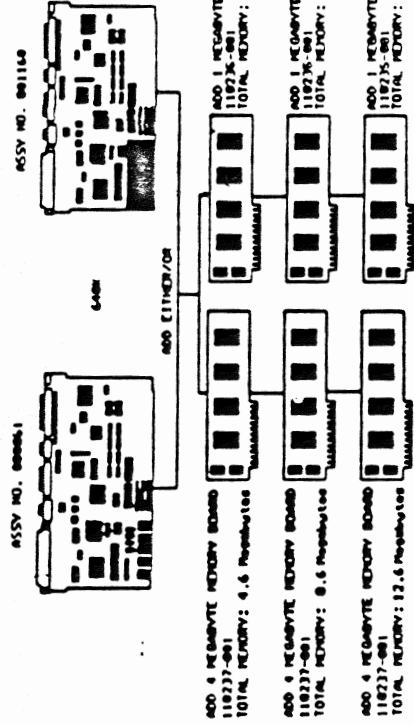

NOTE: THE ABOVE FIGURE DOES NOT REPRESENT ALL POSSIBLE CONFIGURATIONS. MEMORY BOARDS CAN BE INSTALLED IN ANY COMBINATION AND IN ANY AVAILABLE SLOT.

MEMORY EXPANSION ALTERNATIVES

COMPAQ SLT/286 PERSONAL COMPUTER			
SYSTEM MEMORY	MEMORY BOARD ADDED TO SLOT 1	MEMORY BOARD ADDED TO SLOT 2	TOTAL MEMORY
640 KB	1 MB		1.6 MB
640 KB	1 MB	1 MB	2.6 MB
640 KB	1 MB	1 MB	3.6 MB
640 KB	4 MB		4.6 MB
640 KB	1 MB	4 MB	5.6 MB
640 KB	1 MB	1 MB	6.6 MB
640 KB	4 MB	4 MB	8.6 MB
640 KB	1 MB	4 MB	9.6 MB
640 KB	4 MB	4 MB	12.6 MB

NOTE: The above table does not represent all possible configurations. Memory boards can be installed in any combination and in any slot.

COMPAQ SLT/286 MEMORY UPGRADE CHART

SLT 386s/20

COMPAQ SLT 386s/20

COMPATIBILITY LIST

Product	Assy No.	Spare Part No.	Page
SYSTEM BOARDS			
386SX System	001382	118359-001	58
MEMORY BOARDS			
1 MB Memory Module	001385-001	118357-001	X
2 MB Memory Module	001385-002	118356-001	X
4 MB Memory Module	001394	118358-001	X
VIDEO BOARDS			
Advanced Graphics 1024*	109958	114201-001	A-8
Advanced Graphics Memory*	109959	114202-001	X
VGA Pass-Through*	001430	114241-001	X

*Used in Desktop Expansion Base only

MISCELLANEOUS INTERNAL

Serial Interface	000854	110360-001	X
2400-Baud Int Modem	000866	110352-001	X
Backlight Invt	000908	110452-001	X
LED Indicator	001478	118353-001	X
Extender Connector*	000872	110600-001	X
CPU Connector*	001340	110601-001	X
Enhanced 2400-Baud Int Modem	001556	118413-001	X
CD-ROM Adapter	001638	110875-001	X

* Used in Desktop Expansion Base only

MISCELLANEOUS EXTERNAL

Product	Option Part No.	Spare Part No.
External Numeric Keypad	110052-001	110454-001
Desktop Expansion Base	110059-001	N/A
Battery Pack	110287-001	110351-001
Automobile Adapter	110288-001	110708-001
External Battery Charger	110700-001	110706-001
External Storage Module	117079-001	N/A

SLT 386s/20

COMPAQ SLT 386s/20

COMPATIBILITY LIST

FIXED DISK DRIVES

Drive Size	Drive Type	Inter-leave	Inte-grated	Min ROM	Spare Part No.	Controller Assy No.
60 MB	55	1:1	Y	A.1	118355-001	N/A
120 MB	50	1:1	Y	A.1	118360-001	N/A

TAPE DRIVES

Drive Size	Spare Part No.	Tape Cartridge	Spare Part No.
40/60 MB*	112524-001	40 MB (DC 2000)	108142-001
		60 MB	122086-001
80/120 MB*	122087-001	80 MB	116966-001
		120 MB	116967-001

*Used in External Storage Module only.

DISKETTE DRIVES

Size	Spare Part No.
1.2 MB	112566-001 (Used in External Storage Module only.)
360 KB	112567-001 (Used in External Storage Module only.)
1.44 MB	110356-001

CABLE INFORMATION

Cable Function	Used With	Spare Part No.
Mass Storage Power	All FDD	110007-001
FDD Signal	All FDD	110008-001
Diskette Power/Signal	Internal Diskette	110005-001
Signal Cable	Ext Storage Module	110268-001
Power Cable	Ext Storage Module	110270-001
Ground Cable	Display	110503-001
Power Cord	AC Adapter	110543-001
Telephone Cable	Modem	112666-001
Cable Kit (3 Cables)		118368-001

BOARD JUMPER/SWITCH SETTINGS

System Board (001382)*

S1 Settings	Function
S1-1	ON* Reserved
	OFF Reserved
S1-2	ON Power-on password disabled
	OFF* Power-on password enabled

* Default

SLT 386s/20

COMPAQ SLT 386s/20

JUMPER/SWITCH SETTINGS (Cont'd)

External Storage Module

<u>Jumper</u>	<u>Function</u>
Disk	Enables diskette drive
Tape	Enables tape drive

PROCESSOR/COPROCESSOR LOCATIONS

<u>Processor (386SX-20)</u>	<u>Coprocessor (387SX-20)</u>
U56	U75

SYSTEM ROM INFORMATION

System Rom Locations

U73 ODD
U74 EVEN

System Rom Revision (Spare Part No. 118402-001)

<u>Rev</u>	<u>PN on ODD ROM</u>	<u>PN on EVEN ROM</u>
A.1	118283-001	118284-001
050490	118283-002	118284-002
051590	118283-003	118284-003
052990	118283-004	118284-004

POWER SUPPLIES

<u>AC Adapter Power Supply</u>	<u>DC Internal Power Supply</u>
Spare Part No. 118460-001	Spare Part No. 110361-001

Desktop Expansion Base Power Supply

Spare Part No. 110599-001

External Storage Module Power Supply

Spare Part No. 119195-001

ASSY NO. 001382
2 MEGABYTES STANDARD MEMORY

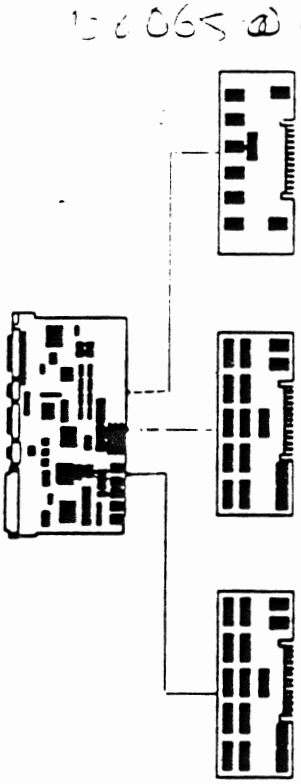

ANY
COMBINATION OF:

1-MB MEMORY MODULE
OPTION PN 118303-001

2-MB MEMORY MODULE
OPTION PN 118304-001

4-MB MEMORY MODULE
OPTION PN 118305-001

MAXIMUM MEMORY: 14 MB

MEMORY EXPANSION ALTERNATIVES

COMPAQ SLT 386s/20 PERSONAL COMPUT

SYSTEM MEMORY	MEMORY BOARDS ADDED TO SLOT 1	SLOT 2	SLOT 3	TO MEMORY
2 MB	1 MB			3 MB
2 MB	2 MB			4 MB
2 MB	1 MB	2 MB		5 MB
2 MB	4 MB			6 MB
2 MB	1 MB	4 MB		7 MB
2 MB	2 MB	4 MB		8 MB
2 MB	1 MB	2 MB	4 MB	9 MB
2 MB	4 MB	4 MB		10 MB
2 MB	1 MB	4 MB	4 MB	11 MB
2 MB	2 MB	4 MB	4 MB	12 MB
2 MB	4 MB	4 MB	4 MB	14 MB

NOTE: The above table does not represent all possible configurations. Memory boards can be installed in combination and in any slot.

COMPAQ SLT 386s/20 MEMORY UPGRADE CHART

DESKPRO

COMPAQ DESKPRO

BOARD COMPATIBILITY LIST

<u>Product</u>	<u>Assy No.</u>	<u>Spare Part No.</u>	<u>Page</u>
SYSTEM BOARDS			
8086 System	000058	101339-001	63
8086 System	000315	105191-001	63
8086 System	000364	106374-001	63
MEMORY CHIPS			
64 X 1 (150 ns) DRAM		105152-001	X
64 X 4 (150 ns) DRAM		106330-001	X
256 X 1 (150 ns) DRAM		105151-001	X
CONTROLLER BOARDS			
Fixed Disk Cntrl	WD1002SWX2	101672-001	63
Fixed Disk Cntrl	WD1002WX2/ WD1002HX4	101672-001	63
Diskette/Printer	000043	101341-001	X
Diskette/Printer	000181-011	101341-001	A-2
VIDEO BOARDS			
Enh Color Graphics*	000410	106373-001	A-5
Enh Color Graphics*	000471	109196-001	A-5
VDU	000031/000160/ 000345	101340-001	A-5
VDU	000525	101340-001	A-7
VGC*	000806/001241/ 109360	109253-001	A-7
* ECG and VGC require system ROM H or later			
MISCELLANEOUS			
Async Comm/Clock	000061	101440-001	A-8
Serial/Parallel Interface	000570	106886-001	A-8
Serial/Parallel Interface	000990	106888-001	A-9
2400-Baud Int Modem	001070	112693-001	X

DESKPRO

COMPAQ DESKPRO

FIXED DISK DRIVES

Drive Size	Drive Type	Inter-leave	Inte-grated	Min ROM	Spare Part No.	Controller Assy No.
10 MB*	1	4:1	N	E	101437-001	WD1002SWX2 WD1002WX2 WD1002HX4
20 MB*	2	4:1	N	E	102777-001	WD1002SWX2 WD1002WX2 WD1002HX4
30 MB*	6	3:1	N	F	101664-001	WD1002SWX2 WD1002WX2 WD1002HX4

* Drive types are set by switch settings on the fixed disk drive controller board or are hard wired depending on the fixed disk drive controller used.

TAPE DRIVE

Drive Size	Spare Part No.	Tape Cartridge	Spare Part No.
10 MB	101438-001	10 MB (DC1000)	101488-001

DISKETTE DRIVE

Size	Spare Part No.
360 KB	102928-001

CABLE INFORMATION

Cable Function	Where Used	Spare Part No.	
Diskette/Tape Signal ¹	All Diskette Drives 10-MB Tape	101380-002	Y
Mass Storage Power ¹	All Diskette, Tape & Fixed Disk Drives	101137-001	
FDD Signal ²	10- & 30-MB FDD	101601-001 101601-002	34 Pin 20 Pin
FDD Signal	20- & 30-MB FDD	100625-003 100625-004	34 Pin 20 Pin
FDD Signal	10-MB FDD (Connects C: & D:)	101554-001	34 Pin

¹ Part of kits 102934-001 & 108146-001

² Part of kits 100641-002 & 102934-001

DESKPRO

COMPAQ DESKPRO

BOARD JUMPER/SWITCH SETTINGS

SYSTEM BOARD (000058, 000315, & 000364)

SW1 SETTINGS

1	2	3	4	5	6	7	8	Function
OFF								Reserved (always OFF)
	ON**							No coprocessor
	OFF							Coprocessor installed
		ON	OFF					128 KB memory
		OFF	OFF					256 KB memory
		OFF	ON					512 KB memory
		ON	ON					640 KB memory
				ON	ON			80 X 25 COMPAQ EGA, compatible EGA, VGA or RGBI primary. 3rd-party monochrome (MDA only) secondary.
				OFF	ON			40 X 25 COMPAQ VDU* primary. 3rd-party monochrome (MDA only) secondary.
				ON	OFF			80 X 25 COMPAQ VDU primary. 3rd-party monochrome (MDA only) secondary.
				OFF	OFF			3rd-party monochrome (MDA only) primary. RGBI secondary.
						ON	ON	One diskette drive
						OFF	ON	Two diskette drives
						ON	OFF	Three diskette drives
						OFF	OFF	Four diskette drives

*With a revision F or later system ROM

** Default

FIXED DISK DRIVE CONTROLLER BOARD (WD1002SWX2)

Drive	SW1 for Drive D		SW1 for Drive C	
	1	2	3	4
10 MB	OFF	OFF	OFF	OFF
20 MB	ON	OFF	ON	OFF
30 MB	ON	ON	ON	ON

FIXED DISK DRIVE CONTROLLER BOARD (WD1002WX2/HX4)* **

Drive	SW1 for Drive D		SW1 for Drive C	
	1	2	3	4
10 MB	ON	ON	ON	ON
20 MB	OFF	ON	OFF	ON
30 MB	OFF	OFF	OFF	OFF

* Do not remove jumpers E17-E18

** Earlier versions of this board have no switch settings and are fixed for 10MB.

DESKPRO

COMPAQ DESKPRO

PROCESSOR/COPROCESSOR LOCATIONS

PROCESSOR (8086-2) COPROCESSOR (8087-2)

U52

U44

SYSTEM ROM INFORMATION

SYSTEM ROM LOCATION: U21

SYSTEM ROM REVISIONS (Spare Part No. 100699-001)

<u>Revision</u>	<u>PN ON ROM</u>
E	100298-004
F	100298-005
G	105681-001
H	106265-001
J	106265-002

POWER SUPPLY

Spare Part No. 102927-001

← USA
JCC

BATTERY

Spare Part No. 101260-001 (Mounted on the Async Clock/Comm Board)

ASSY NO. 000050
ASSY NO. 000315

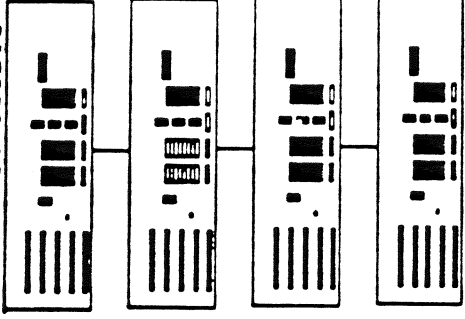

256K System Board

Remove Socketed RAM

8ea 256K Chips
2-001

Total Memory: 640K

ASSY NO. 000364

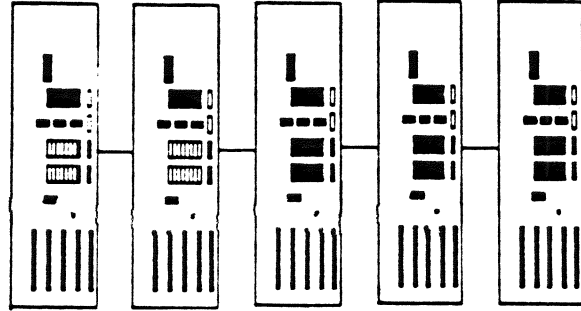

256K System Board

Remove 2 Parity Chip
from U109 & U110

Add 18ea 256K Chips
113012-001

Rotate Shunt Module
U118 180 degrees

Total Memory: 640K

COMPAQ DESKPRO MEMORY UPGRADE CHART

DP286-8

8-MHz COMPAQ DESKPRO 286

BOARD COMPATIBILITY LIST

Product	Assy No.	Spare Part No.	Page
SYSTEM BOARDS			
80286 System	000094	102774-001	69
80286 System	000361	106434-001	69
MEMORY BOARDS			
512/2048 Mem Exp	000307/000308	105033-001	A-1
System Memory	000130/000178/ 000382	102710-001	70
MEMORY CHIPS			
64 X 1 (150 ns) DRAM		105152-001	X
256 X 1 (150 ns) DRAM		105151-001	X
CONTROLLER BOARDS			
Fixed Disk Cntrl	WD1002WAH	102778-001	A-1
Multipur Cntrl	000142	102705-001	A-2
Multipur Cntrl	000181-001/021	102705-001	A-2
Multipur Fixed Disk	000336	104174-001	A-2
Multipur Fixed Disk	000519/000815	104174-001	A-3
ESDI Fixed Disk (3.1)	WD1005WAH	108140-001	A-1
ESDI 130/300	WD1007AWAH	113265-001	A-1
VIDEO BOARDS			
Enh Color Graphics*	000410	106373-001	A-5
Enh Color Graphics*	000471	109196-001	A-5
VDU	000031/000160/ 000345	101340-001	A-5
VDU	000525	101340-001	A-7
VGC*	000806/001241/ 109360	109253-001	A-7
* ECG and VGC require system ROM F or later			
MISCELLANEOUS			
Serial/Parallel Interface	000570	106886-001	A-8
Serial/Parallel Interface	000990	106886-001	A-9
2400-Baud Int. Modem	001070	112693-001	X

DP286-8

8-MHz COMPAQ DESKPRO 286

FIXED DISK DRIVES

Drive Size	Drive Type	Inter-leave	Inte-grated	Min ROM	Spare Part No.	Controller Assy No.
20 MB ¹	2	4:1	N	A	102777-001	WD1002WAH
30 MB ¹	6	3:1	N	F	101664-001	WD1002WAH
40 MB*	17	3:1	Y	F	108058-001	000336 000519 000815
70 MB	12	2:1	N	F	102932-001	WD1002WAH
130 MB ²	25 ³	3:1	N	F	108080-001	WD1005WAH
	35 ³	1:1		F		WD1007AWAH

* See page A-13 for dual 40-MB drive configuration information.

¹ Comes formatted for the COMPAQ DESKPRO. Must be reformatted when used in the 8-MHz COMPAQ DESKPRO 286.

² Comes formatted as type 35 for the WD1007AWAH controller. If used with the WD1005WAH controller (type 25) you must perform an unconditional format followed by a surface analysis using ADVANCED DIAGNOSTICS 5.04 or greater.

³ MS-DOS 3.1 or earlier supports type 25 only. MS-DOS 3.2 or later supports either type. Use type 25 if the application software supports only 17 sectors per track.

TAPE DRIVES

Drive Size	Spare Part No.	Tape Cartridge	Spare Part No.
10 MB	101438-001	10 MB (DC1000)	101488-001
40 MB	108081-001	40 MB (DC2000)	108142-001

DISKETTE DRIVES

Size	Spare Part No.
360 KB	102928-001
1.2 MB	102775-001
1.44 MB*	113263-001 (Requires minimum sys. ROM N.3)

* Requires MS-DOS Version 3.31 Revision A if installed as drive B, and MS-DOS Version 3.31 Revision B if installed as drive A.

CABLE INFORMATION

Cable Function	Used With	Spare Part No.
Diskette/Tape Signal ¹	All Diskette Drives All Tape Drives	101380-002
Mass Storage Power ¹	All Diskette, Tape, & Fixed Disk Drives	101137-001
FDD Signal ²	30-MB FDD	101601-001 101601-002
FDD Signal	20-, 30- & 70-MB FDD	100625-003 100625-004
FDD Signal ³	40-MB FDD	108086-001
FDD Signal	40-MB FDD (Dual Drives)	108087-001
FDD Signal ⁴	130-MB FDD	100625-005 100625-006

¹ Part of kits 102934-001 & 108146-001 ³ Part of kit 108146-001

² Part of kits 100641-002 & 102934-001 ⁴ Part of kit 108249-001

DP286-8

8-MHz COMPAQ DESKPRO 286

BOARD JUMPER/SWITCH SETTINGS

SYSTEM BOARD (000094)

Jumper	Pins	Function
ED	1 to 2	3rd-party monochrome (MDA only)
ED	2 to 3	COMPAQ VDU, COMPAQ EGA, compatible EGA, RGBI, or VGC (default)
ES	1 to 2	CPU boot speed 8 MHz (default)
ES	2 to 3	CPU boot speed 6 MHz
EM		Reserved

SYSTEM BOARD (000361)

SW1 SETTINGS

1	2	3	4	5	6	7	8	Function
ON								With 64K X 1 DRAM
OFF								With 256K X 1 DRAM
	ON	ON						Disable RAM and ROM
	ON	OFF						0-256 KB base memory
	OFF	ON						0-512 KB base memory
	OFF	OFF						Enable all base memory
			OFF	OFF				With 64K X 1 DRAM
			ON	ON				256K X 1 DRAM. No extended memory
	150ns (or faster) 256K X 1 chips only		ON	OFF				Enable bank 2 for 1.0 to 1.5 MB of memory
			OFF	ON				Enable banks 2 & 3 for 1.0 to 2.0 MB of memory
			OFF	OFF				Enable all banks for 1.0 to 2.5 MB of memory
					OFF*			CPU boot speed 8 MHz
					ON			CPU boot speed 6 MHz
						OFF		Reserved
							ON*	COMPAQ VDU & EGA, compatible EGA, RGBI, or VGC
							OFF	3rd-party monochrome (MDA only)

* Default

DP286-8

8-MHz COMPAQ DESKPRO 286

BOARD JUMPER/SWITCH SETTINGS

SYSTEM MEMORY BOARD (000130*)

Memory Type	Jumper Settings	Address Range Enabled
64K X1 chips	E1 to E2	0 - 640 KB
	E5 to E6	
64K X 1 chips	E2 to E3	0 - 512 KB
	E4 to E5	
256K X 1 chips	E2 to E3	0 - 640KB**
	E5 to E6	1 - 2.5 MB
256K X 1 chips	E2 to E3	0 - 640 KB
	E4 to E5	

*Not PAL-dependent
** 640 KB to 1 MB reserved

SYSTEM MEMORY BOARD (000178* and 000382**) - PAL in U90

Memory Type	E1 Jumper Pins	Address Range Enabled
64K X 1 chips	1 to 2	0 - 640 KB
	5 to 6	
64K X 1 chips	1 to 2	0 - 512 KB
	4 to 5	
64K X 1 chips*	2 to 3	0 - 256 KB
	4 to 5	
256K X 1 chips	2 to 3	0 - 640 KB***
	5 to 6	1 - 2.5 MB
256K X 1 chips**	2 to 3	0 - 640 KB
	4 to 5	

* Only valid with 102665 PAL
** Only valid with 105615 PAL
*** 640 KB to 1 MB reserved

PROCESSOR LOCATIONS (80286-8)

000094 System Board	000361 System Board
U60	U3

COPROCESSOR LOCATIONS (80287-3 or -8)

000094 System Board	000361 System Board
U74	U17

DP286-8

8-MHz COMPAQ DESKPRO 286

SYSTEM ROM INFORMATION

SYSTEM ROM LOCATIONS

000130 Sys Memory Bd	000178 & 000382 Sys Mem Bd	000361 System Bd
U82 ODD U88 EVEN	U84 ODD U92 EVEN	U92 ODD U49 EVEN

SYSTEM OPTION ROM LOCATIONS

000130 Sys Memory Bd	000178 & 000382 Sys Mem Bd	000361 System Bd
U78 ODD U85 EVEN	U79 ODD U89 EVEN	U116 ODD U75 EVEN

SYSTEM ROM REVISIONS (Spare Part No. 105035-001)

Rev	PN on ODD ROM	PN on EVEN ROM
A	102667-001	102669-001
B	102667-002	102669-002
C	102667-003	102669-003
D	105620-001	105622-001
E	106261-001	106263-001
F	106437-001	106438-001
G	106580-001	106581-001
J	106778-001	106779-001
K	106778-002	106779-002
M	106970-001	106971-001
N.3	106970-002	106971-002
P.1	109739-001	109740-001
R.2	109739-002	109740-002
S.1	109739-003	109740-003

POWER SUPPLY

Spare Part No. 102927-001

BATTERY

Spare Part No. 102929-001

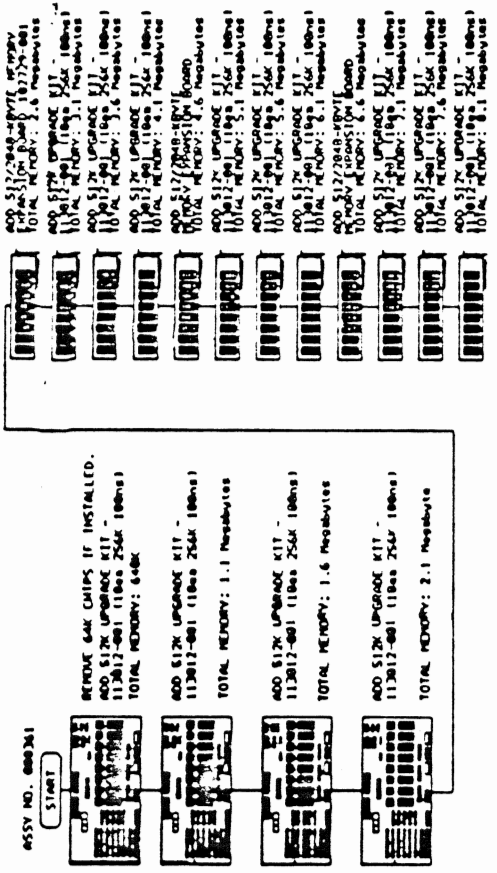

8-MHz COMPAQ DESKPRO 286 MEMORY UPGRADE CHART No. 1

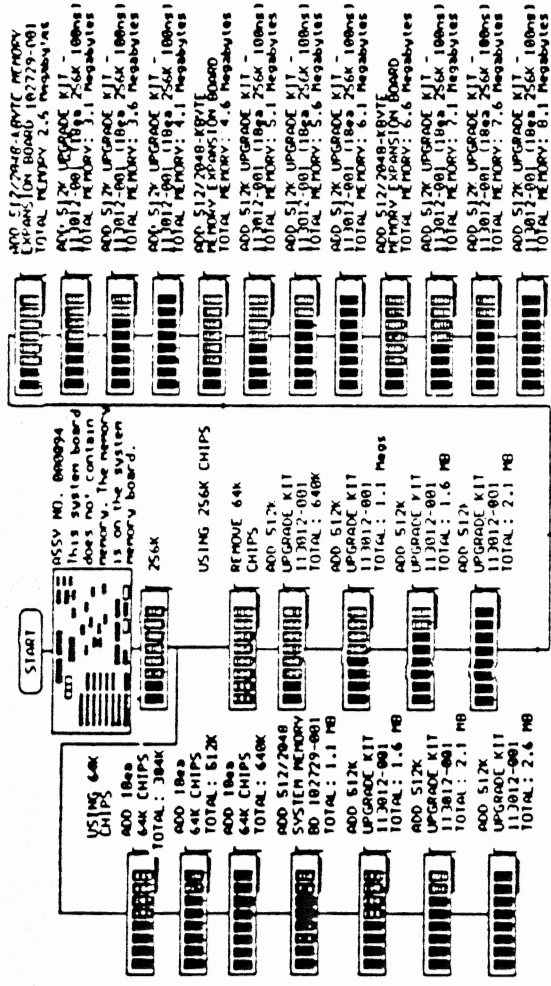

ADD 512/2048-KBVT MEMORY EXPANSION BOARD 102729-001
TOTAL MEMORY: 2.6 Megabytes

ADD 512k UPGRADE KIT - 113012-001 (118k 256k 100ns)
TOTAL MEMORY: 3.1 Megabytes

ADD 512k UPGRADE KIT - 113012-001 (118k 256k 100ns)
TOTAL MEMORY: 3.6 Megabytes

ADD 512k UPGRADE KIT - 113012-001 (118k 256k 100ns)
TOTAL MEMORY: 4.1 Megabytes

ADD 512/2048-KBVT MEMORY EXPANSION BOARD

ADD 512k UPGRADE KIT - 113012-001 (118k 256k 100ns)
TOTAL MEMORY: 5.1 Megabytes

ADD 512k UPGRADE KIT - 113012-001 (118k 256k 100ns)
TOTAL MEMORY: 5.6 Megabytes

ADD 512/2048-KBVT MEMORY EXPANSION BOARD

ADD 512k UPGRADE KIT - 113012-001 (118k 256k 100ns)
TOTAL MEMORY: 6.1 Megabytes

ADD 512k UPGRADE KIT - 113012-001 (118k 256k 100ns)
TOTAL MEMORY: 6.6 Megabytes

ADD 512k UPGRADE KIT - 113012-001 (118k 256k 100ns)
TOTAL MEMORY: 7.1 Megabytes

ADD 512k UPGRADE KIT - 113012-001 (118k 256k 100ns)
TOTAL MEMORY: 7.6 Megabytes

ADD 512k UPGRADE KIT - 113012-001 (118k 256k 100ns)
TOTAL MEMORY: 8.1 Megabytes

8-MHz COMPAQ DESKPRO 286 MEMORY UPGRADE CHART No. 2

DP286-12

12-MHz COMPAQ DESKPRO 286

BOARD COMPATIBILITY LIST

Product	Assy No.	Spare Part No.	Page
SYSTEM BOARDS			
80286 System	000555/000700	106707-001	77
MEMORY BOARDS			
512/2048 Mem Exp	000307/000308	105033-001	A-1
MEMORY CHIPS			
256 X 1 (100 ns) DRAM		113017-001	X
CONTROLLER BOARDS			
Fixed Disk Cntrl	WD1002WAH	102778-001	A-1
ESDI Fixed-Disk (3.1)	WD1005WAH	108140-001	A-1
ESDI (1:1)	WD1007AWAH	113265-001	A-1
Tape Adapter	000774	113259-001	A-3
Multipur Fixed Disk	000815	113446-001	A-3
ESDI External 300/600	001091	115839-001	A-3
15 MHz ESDI Cntrl	001283/001628	115188-001	A-4
ESDI/Diskette Cntrl	001472	115374-001	A-4
VIDEO BOARDS			
Enh Color Graphics*	000410	106373-001	A-5
Enh Color Graphics*	000471	109196-001	A-5
VDU	000031/000160/ 000345	101340-001	A-5
VDU	000525	101340-001	A-7
VGC*	000806/001241/ 109360	109253-001	A-7
Advanced Graphics 1024	109958	114201-001	A-8
Advanced Graphics Memory	109959	114202-001	X
* ECG and VGC require system ROM K or later			
MISCELLANEOUS			
Serial/Parallel Interface	000570	106886-001	A-8
Serial/Parallel Interface	000990	106886-001	A-9
2400-Baud Int Modem	001070	112693-001	X

DP286-12

12-MHz COMPAQ DESKPRO 286

FIXED DISK DRIVES

Drive Size	Drive Type	Inter-leave	Inter-grated	Min ROM	Spare Part No.	Controller Assy No.
20 MB	2	1:1	Y	K	114483-001	000815
20 MB	2	3:1	Y	K	113016-001	000815
40 MB*	17	3:1	Y	K	108058-001	000815
40 MB	22	1:1	Y	K	113030-001	000815
40 MB ¹	43	1:1	Y	K	113030-001	000815
70 MB	12	2:1	N	K	102932-001	WD1002WAH
130 MB ²	25 ³	3:1	N	K	108080-001	WD1005WAH
	35 ³	1:1		K		WD1007AWAH
300 MB ⁴	38	1:1	N	P.1	113219-001	001091 001283 001472 ⁵ 001628

* See page A-13 for dual 40-MB drive configuration information

¹ Requires MS-DOS 3.2 or later

² Comes formatted as type 35 for the WD1007AWAH controller. If used with the WD1005WAH controller (type 25) you must perform an unconditional format followed by a surface analysis using ADVANCED DIAGNOSTICS 5.04 or greater.

³ MS-DOS 3.1 or earlier supports type 25 only. MS-DOS 3.2 or later supports either type. Use type 25 if the application software supports only 17 sectors per track.

⁴ Used in Fixed Disk Drive Expansion Unit. Requires MS-DOS 3.3 or later.

⁵ Disable diskette circuitry when using as a fixed disk drive controller.

TAPE DRIVES

Drive Size	Spare Part No.	Tape Cartridge	Spare Part No.
40 MB	108081-001	40 MB (DC2000)	108142-001
135 MB	113218-001	135 MB (DC600 XTD)	113234-001
150/250 MB	115368-001	150 MB (DC600 XTD)	113234-001
		250 MB	115298-001

DISKETTE DRIVES

Size	Spare Part No.
360 KB	102928-001
1.2 MB	102775-001
1.44 MB*	113263-001

* Requires system ROM N.3 or later for use with MS-DOS and system ROM P.1 or later for use with MS OS/2 Version 1.1. Requires MS-DOS Version 3.31 Revision A if installed as drive B, and MS-DOS Version 3.31 Revision B if installed as drive A.

DP286-12

12-MHZ COMPAQ DESKPRO 286

CABLE INFORMATION

Cable Function	Used With	Spare Part No.	
Diskette/Tape Signal ¹	All Diskette Drives 40-MB Tape	101380-002	
Mass Storage Power ¹	All	101137-001	
Tape Signal	135-MB Tape	113198-001	
	150/250 MB Tape	115196-001	
FDD Signal	70-MB FDD	100625-003	34 Pin
		100625-004	20 Pin
FDD Signal ²	20-MB (1:1 & 3:1), 40-MB (1:1 & 3:1)	108088-001	
FDD Signal	Dual 20 & 40-MB FDD	108087-001	
FDD Signal ³	130-MB FDD	100625-005	34 Pin
		100625-006	20 Pin
External I/O:	Expansion Unit	115810-001	34 Pin
		100625-006	20 Pin
Telephone Cable	Modem	112666-001	

¹ Part of kits 102934-001 & 108146-001 ³ Part of kit 108249-001

² Part of kit 108146-001

BOARD JUMPER/SWITCH SETTINGS

SYSTEM BOARD (000555 & 000700)

SW1 SETTINGS

1	2	3	4	5	6	7	8	Function
ON								With 64K X 1 DRAM
OFF*								With 256K X 1 DRAM
	ON	ON						Disable RAM and ROM
	ON	OFF						0-256 KB base memory
	OFF	ON						0-512 KB base memory
	OFF*	OFF*						Enable all base memory
			OFF	OFF				With 64K X 1 DRAM
			ON	N*				256K X 1 DRAM. No extended memory
			ON	F				Enable bank 2 for 1.0 to 1.5 MB of memory
			OFF	ON				Enable banks 2 & 3 for 1.0 to 2.0 MB of memory
			OFF	OFF				Enable all banks for 1.0 to 2.5 MB of memory
						OFF*		CPU boot speed 12 MHz
						ON		CPU boot speed 8 MHz
							OFF	Reserved
							ON*	COMPAQ VDU & EGA, compatible EGA, RGBI, or VGC
							OFF	3rd-party monochrome (MDA only)

100-ns (or
faster 256K X 1
chips only)

Jumper E5

1 - 2	CPU boot speed 12 MHz
2 - 3*	CPU boot speed 12 MHz except 8 MHz when accessing diskette drive

* Default

DP286-12

12-MHz COMPAQ DESKPRO 286

PROCESSOR/COPROCESSOR LOCATIONS

Processor (80286-12) Coprocessor (80287-8)

U3 U17

SYSTEM ROM INFORMATION

SYSTEM ROM LOCATIONS SYSTEM OPTION ROM LOCATIONS

U92 ODD U116 ODD
U49 EVEN U75 EVEN

SYSTEM ROM REVISIONS (Spare Part No. 105035-001)

<u>Rev</u>	<u>PN on ODD ROM</u>	<u>PN on EVEN ROM</u>
K	106778-002	106779-002
M	106970-001	106971-001
N.3	106970-002	106971-002
P 1	109739-001	109740-001
R.2	109739-002	109740-002
S 1	109739-003	109740-003

POWER SUPPLY

Spare Part No. 108065-001

BATTERY

Spare Part No. 102929-001

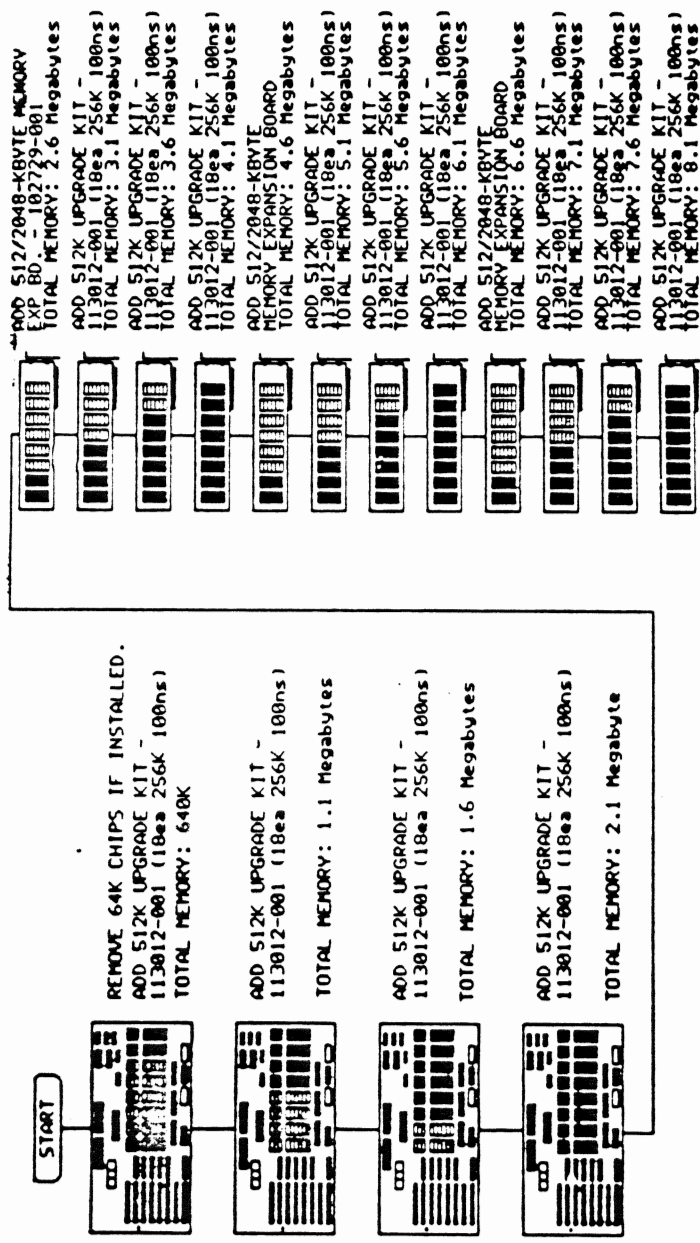

12-MHz COMPAQ DESKPRO 286 MEMORY UPGRADE CHART

DP286e

COMPAQ DESKPRO 286e

BOARD COMPATIBILITY LIST

<u>Product</u>	<u>Assy No.</u>	<u>Spare Part No.</u>	<u>Page</u>
SYSTEM BOARDS			
80286 System	001226	117469-001	B3/84
MEMORY BOARDS			
4MB Memory Module	000758/000993/ 001166-001/002	113226-001	X
1MB Memory Module	000762/000981/ 001256 001259	113225-001	X
1MB 16-Bit Mem Exp	001244	117471-001	84
4MB 16-Bit Mem Exp	001247	117470-001	85
CONTROLLER BOARDS			
Tape Adapter	000774	113259-001	A-3
ESDI External 300/600	001091	115839-001	A-3
15 MHz ESDI Cntrl	001283/001628	115188-001	A-4
ESDI/Diskette Cntrl	001472	115374-001	A-4
VIDEO BOARDS			
Advanced Graphics 1024	109958	114201-001	A-8
Advanced Graphics Memory	109959	114202-001	X
VGA Pass-Through	001430	114241-001	X
MISCELLANEOUS			
Serial/Parallel Interface	000570	106886-001	A-8
Serial/Parallel Interface	000990	106886-001	A-9
2400-Baud Int Modem	001070	112693-001	X

DP286e

COMPAQ DESKPRO 286e

FIXED DISK DRIVES

Drive Size	Drive Type	Inter-leave	Inte-grated	Min ROM	Spare Part No.	Controller Assy No.
20 MB	2	1:1	Y	B.3	114465-001	N/A
40 MB	22	1:1	Y	B.3	112526-001	N/A
40 MB	43	1:1	Y	B.3	112526-001	N/A
84 MB	27	1:1	Y	B.3	112438-001	N/A
110 MB	33	1:1	Y	B.3	112525-001	N/A
300 MB ¹	38	1:1	N	B.3	113219-001	001091 001283 ² 001472 ² 001628

¹ Used in Fixed Disk Expansion Unit. Requires MS-DOS 3.3 or later

² Disable diskette circuitry when using as a fixed disk drive controller

TAPE DRIVES

Drive Size	Spare Part No.	Tape Cartridge	Spare Part No.
40/60 MB	112524-001	40 MB (DC2000)	108142-001
		60 MB	122086-001
80/120 MB	122087-001	80 MB	116966-001
		120 MB	116967-001
		135 MB (DC600 XTD)	113234-001
135 MB	112523-001	135 MB (DC600 XTD)	113234-001
150/250 MB	115220-001	150 MB (DC600 XTD)	113234-001
		250 MB	115298-001

DISKETTE DRIVES

Size	Spare Part No.
360 KB	112567-001
1.2 MB	112566-001
1.44 MB*	112565-001

* Requires MS-DOS Version 3.31 Revision A if installed as drive B, and MS-DOS Version 3.31 Revision B if installed as drive A.

CABLE INFORMATION

Cable Function	Used With	Spare Part No.
Diskette/Tape Signal	All Diskette Drives 40/60-MB Tape	113594-001
Mass Storage Power	All Diskette & Tape Drives	113596-001 112669-003
Mass Storage Power	All Internal FDD Drive C	101741-001
Mass Storage Power	All Internal FDD Drive D	101741-004
Tape Signal	135-, 150/250- & 80/120-MB Tape	113198-002
FDD Signal	All Internal FDD Drive C	113595-001
FDD Signal	All Internal FDD Drive D	112528-001
External I/O	Expansion Unit	115810-001
Telephone Cable	Modem	112668-001
VGA Pass-Through	Adv Graphics	114229-001

DP286e

COMPAQ DESKPRO 286e

BOARD JUMPER/SWITCH SETTINGS

SYSTEM BOARD (001226)

SW1 SETTINGS

1	2	3	4	5	6	Function
ON*	ON*					Base Memory 640 KB
ON	OFF					Base Memory 512 KB
OFF	OFF					Base Memory 256 KB
OFF	ON					Reserved
		ON				Option ROM enable
		OFF*				Option ROM disable
			ON*			CPU boot speed 12 MHz except 8 MHz when accessing diskette drive
			OFF			CPU boot speed 12 MHz
				OFF		Reserved
					ON*	EGA, RGBI, or VGC
					OFF	3rd-party monochrome (MDA only)

* Default

SYSTEM BOARD (001226)

SW2 SETTINGS

1	2	3	4	5	6	7	8	Function
OFF*								Primary diskette & fixed disk drive address select (3FX & 1FX)
ON								Secondary diskette & fixed disk drive address select (37X & 17X)
	OFF*							Enable power-on pass- word
	ON							Disable power-on pass- word
		OFF*						Enable integrated fixed disk drive controller
		ON						Disable integrated fixed disk drive controller
			OFF*	OFF*				Serial interface COM1 (3FX, IRQ4)
			ON	OFF				Serial interface COM2 (2FX, IRQ3)
			OFF	ON				Reserved
			ON	ON				Disable serial interface
					ON*	OFF*		Select printer interface LPT1 or LPT2 (38X)
					OFF	ON		Select printer interface LPT2 (37X)
					OFF	OFF		Reserved
					ON	ON		Disable printer interface
							ON	Disable integrated VGC
							OFF*	Enable integrated VGC

* Default

Continued

DP286e

COMPAQ DESKPRO 286e

BOARD JUMPER/SWITCH SETTINGS

SYSTEM BOARD (001226)

Jumper	Setting	Function
E4	1-2	Enable IRQ12 from bus, disable pointing device
E4	2-3*	Enable pointing device interface
E11	1-2	8-MHz coprocessor
E11	2-3*	12-MHz coprocessor

* Default

EXTENDED/EXPANDED MEMORY JUMPER SETTINGS

JUMPERS	MEMORY EXPANSION OPTION	EXTENDED	EXPANDED
E9 E8 E7	MODULE B	1-2	2-3
E6 E5 E4	MODULE A	1-2	2-3
E3 E2 E1	MEMORY EXPANSION BOARD	1-2	2-3

Mem Exp Bd	Mem Mod A	Mem Mod B	1-MB Expansion Board (001244) Jumper Settings			Total Mem	Ext Mem	Exp Mem
			E1-E3	E4-E6	E7-E9			
1 MB			1-2 EXT	2-3*	2-3*	2 MB	1 MB	
			2-3 EXP	2-3*	2-3*	2 MB		1 MB
1 MB	1 MB		1-2 EXT	1-2 EXT	2-3*	3 MB	2 MB	
			1-2 EXT	2-3 EXP	2-3*	3 MB	1 MB	1 MB
			2-3 EXP	2-3 EXP	2-3*	3 MB		2 MB
1 MB	1 MB	1 MB	1-2 EXT	1-2 EXT	1-2 EXT	4 MB	3 MB	
			1-2 EXT	1-2 EXT	2-3 EXP	4 MB	2 MB	1 MB
			1-2 EXT	2-3 EXP	2-3 EXP	4 MB	1 MB	2 MB
1 MB	4 MB		1-2 EXT	1-2 EXT	2-3*	6 MB	5 MB	
			1-2 EXT	2-3 EXP	2-3*	6 MB	1 MB	4 MB
			2-3 EXP	2-3 EXP	2-3*	6 MB		5 MB
1 MB	1 MB	4 MB	1-2 EXT	1-2 EXT	1-2 EXT	7 MB	6 MB	
			1-2 EXT	1-2 EXT	2-3 EXP	7 MB	2 MB	4 MB
			1-2 EXT	2-3 EXP	2-3 EXP	7 MB	1 MB	5 MB
1 MB	4 MB	1 MB	1-2 EXT	1-2 EXT	1-2 EXT	7 MB	6 MB	
			1-2 EXT	1-2 EXT	2-3 EXP	7 MB	5 MB	1 MB
			1-2 EXT	2-3 EXP	2-3 EXP	7 MB	1 MB	5 MB
1 MB	4 MB	4 MB	1-2 EXT	1-2 EXT	1-2 EXT	10 MB	9 MB	
			1-2 EXT	1-2 EXT	2-3 EXP	10 MB	5 MB	4 MB
			1-2 EXT	2-3 EXP	2-3 EXP	10 MB	1 MB	8 MB

* Default

DP286e

COMPAQ DESKPRO 286e

EXTENDED/EXPANDED MEMORY JUMPER SETTINGS (Cont'd)

Mem Exp Bd	Mem Mod A	Mem Mod B	4-MB Expansion Board (001247) Jumper Settings			Total Mem	Ext Mem	Exp Mem
			E1-E3	E4-E6	E7-E9			
4 MB			1-2 EXT	2-3*	2-3*	5 MB	4 MB	
			2-3 EXP	2-3*	2-3*	5 MB		4 MB
4 MB	1 MB		1-2 EXT	1-2 EXT	2-3*	6 MB	5 MB	
			1-2 EXT	2-3 EXP	2-3*	6 MB	4 MB	1 MB
			2-3 EXP	2-3 EXP	2-3*	6 MB		5 MB
4 MB	1 MB	1 MB	1-2 EXT	1-2 EXT	1-2 EXT	7 MB	6 MB	
			1-2 EXT	1-2 EXT	2-3 EXP	7 MB	5 MB	1 MB
			1-2 EXT	2-3 EXP	2-3 EXP	7 MB	4 MB	2 MB
4 MB	4 MB		1-2 EXT	1-2 EXT	2-3*	9 MB	8 MB	
			1-2 EXT	2-3 EXP	2-3*	9 MB	4 MB	4 MB
			2-3 EXP	2-3 EXP	2-3*	9 MB		8 MB
4 MB	1 MB	4 MB	1-2 EXT	1-2 EXT	1-2 EXT	10 MB	9 MB	
			1-2 EXT	1-2 EXT	2-3 EXP	10 MB	5 MB	4 MB
			1-2 EXT	2-3 EXP	2-3 EXP	10 MB	4 MB	5 MB
4 MB	4 MB	1 MB	1-2 EXT	1-2 EXT	1-2 EXT	10 MB	9 MB	
			1-2 EXT	1-2 EXT	2-3 EXP	10 MB	8 MB	1 MB
			1-2 EXT	2-3 EXP	2-3 EXP	10 MB	4 MB	5 MB
4 MB	4 MB	4 MB	1-2 EXT	1-2 EXT	1-2 EXT	13 MB	12 MB	
			1-2 EXT	1-2 EXT	2-3 EXP	13 MB	8 MB	4 MB
			1-2 EXT	2-3 EXP	2-3 EXP	13 MB	4 MB	8 MB

* Default

DP286e

COMPAQ DESKPRO 286e

PROCESSOR/COPROCESSOR LOCATIONS

PROCESSOR (80286-12)	COPROCESSOR (80287-8 or 80C287-12)
U102	U124

SYSTEM ROM INFORMATION

SYSTEM ROM LOCATIONS

System Board Assy	System ROM Locations
001226	U78 ODD U61 EVEN

SYSTEM ROM REVISIONS (Spare Part No. 117481-001)

Rev.	PN on ODD ROM	PN on EVEN ROM
B.3	117507-003	117508-003
C.1	117507-004	117508-004
C.3	117507-005	117508-005

POWER SUPPLY

Spare Part No. 112570-001

BATTERY/CLOCK MODULE

Spare Part No. 107872-001

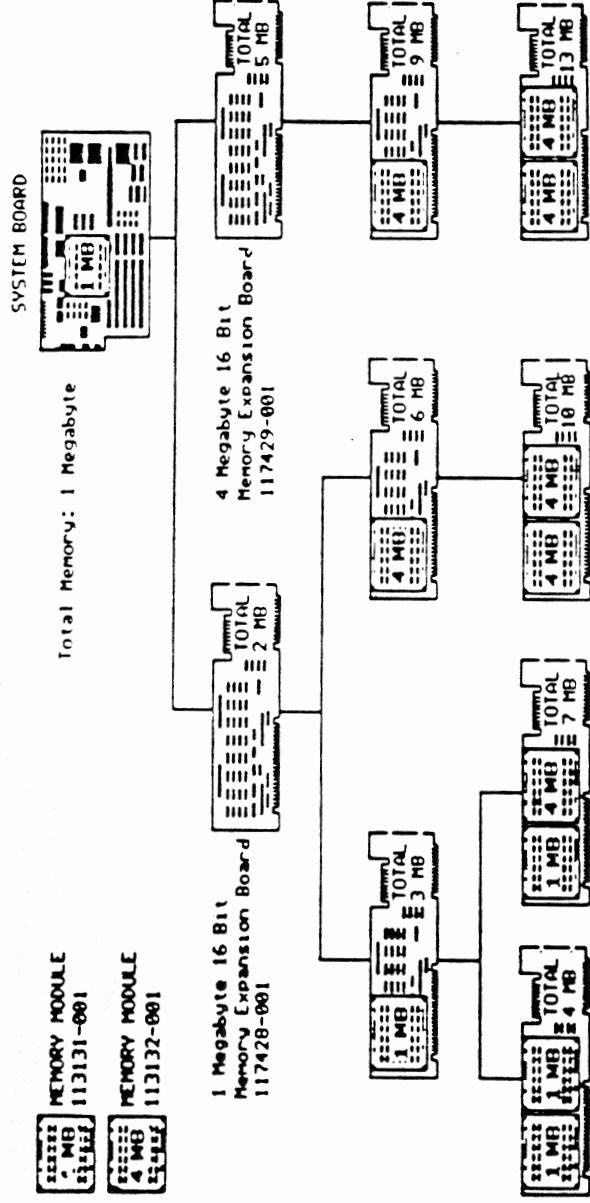

COMPAQ DESKPRO 286e MEMORY UPGRADE CHART

DP286N

COMPAQ DESKPRO 286N

BOARD COMPATIBILITY LIST

Product	Assy No.	Spare Part No.	Page
---------	----------	----------------	------

SYSTEM BOARDS

80286 System	001448	118738-001	90
--------------	--------	------------	----

MEMORY BOARDS

Memory Expansion	001457	118739-001	X
4 MB Memory Module	118665-002	118741-001	X
1 MB Memory Module	118666-001	113911-001	X

MISCELLANEOUS

Serial/Parallel Interface	000570	106886-001	A-8
Serial/Parallel Interface	000990	106886-001	A-9
2400-Baud Int Modem	001070	112693-001	X
Backplane Board	001451	118742-001	X

FIXED DISK DRIVES

Drive Size	Drive Type	Inter-leave	Inte-grated	Min ROM	Spare Part No.	Controller Assy No.
20 MB	2	1:1	Y	A	113959-001	N/A
40 MB	22*	1:1	Y	A	113960-001	N/A
60 MB	55	1:1	Y	A	113961-001	N/A
120 MB	50	1:1	Y	A	113962-001	N/A

* May be drive type 22 or drive type 17

DISKETTE DRIVES

Size	Spare Part No.
1.2 MB	112566-001
1.44 MB	113958-001

CABLE INFORMATION

Cable Function	Used With	Spare Part No.
Diskette Signal	1.2 MB Diskette	113938-001
Diskette Power	1.2 MB Diskette & Fixed Disk Drive	113939-001
Diskette Signal/Power	1.44 MB Diskette	113930-001
Mass Storage Power	All FDD	113927-001
Mass Storage Signal	All FDD	113928-001

DP286N

COMPAQ DESKPRO 286N

BOARD JUMPER/SWITCH SETTINGS

SYSTEM BOARD (001448)

SWITCH	SETTING	FUNCTION
SW1-1	ON*	Enable integrated VGA
SW1-1	OFF	Disable integrated VGA
SW1-2	ON*	Enable SETUP
SW1-2	OFF	Disable SETUP
SW1-3	ON*	Enable external boot
SW1-3	OFF	Disable external boot
SW1-4	ON*	Enable power-on password
SW1-4	OFF	Disable power-on password
SW1-5	ON*	8-MHz 80287 coprocessor or coprocessor not installed
SW1-5	OFF	12-MHz 80C287 coprocessor
SW1-6	ON*	Enable diskette write
SW1-6	OFF	Disable diskette write

* Default

PROCESSOR/COPROCESSOR LOCATIONS

Processor (80286-12) Coprocessor (80287-8 or 80C287-12)

Not field replaceable U60

SYSTEM ROM INFORMATION

SYSTEM ROM LOCATION

U81

SYSTEM ROM REVISIONS (Spare Part No. 118756-001)

Rev	PN on ROM
032690	118717-002
040590	118717-003
042590	118717-004
050390	118717-005
080290	118717-006

POWER SUPPLY

Spare Part No. 118743-001

BATTERY/CLOCK MODULE

Spare Part No. 107872-001

**MEMORY EXPANSION BOARD
OPTION PN 118700-001**

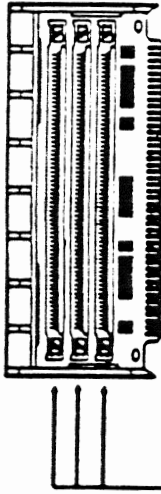

**1-MB MEMORY MODULE
OPTION PN 118688-001**



**4-MB MEMORY MODULE
OPTION PN 118690-001**



**INSTALL MEMORY MODULES IN ANY
COMBINATION AND IN ANY ORDER ON
THE MEMORY EXPANSION BOARD**

**INSTALL MEMORY EXPANSION BOARD
ON SYSTEM BOARD**

MAXIMUM MEMORY: 13 MEGABYTES

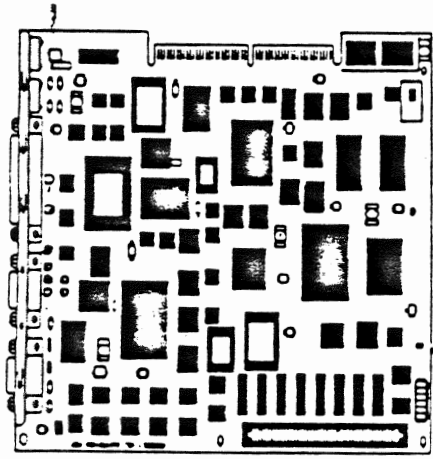

COMPAQ DESKPRO 286N MEMORY UPGRADE CHART

DP386

COMPAQ DESKPRO 386

BOARD COMPATIBILITY LIST

Product	Assy No.	Spare Part No.	Page
SYSTEM BOARDS			
386 System	000401	108060-001	95
386 System	000558	108407-001	95
MEMORY BOARDS			
32-Bit Sys Mem	000413	108059-001	96
1 - 2 MB 32-Bit	000450	108082-001	96
0.5-2.0 MB 16-Bit	000458	108138-001	96
4 - 8 MB 32-Bit	000459	108083-001	96
MEMORY CHIPS			
256 X 1 (100 ns) SCRAM		108143-001	X
1 MB X 1 (100 ns) SCRAM		108144-001	X
CONTROLLER BOARDS			
Fixed Disk Cntrl	WD1002WAH	102778-001	A-1
ESDI Fixed Disk (3.1)	WD1005WAH	108140-001	A-1
ESDI 130/300	WD1007AWAH	113265-001	A-1
Tape Adapter	000774	113259-001	A-3
Multipurpose Fixed Disk	000815	113446-001	A-3
ESDI External 300/600	001091	115839-001	A-3
15 MHz ESDI Cntrl	001283/001628	115188-001	A-4
ESDI/Diskette Cntrl	001472	115374-001	A-4
VIDEO BOARDS			
Enh Color Graphics*	000410	106373-001	A-5
Enh Color Graphics*	000471	109196-001	A-5
VDU	000031/000160/ 000345	101340-001	A-5
VDU	000525	101340-001	A-7
VGC*	000806/001241 109360	109253-001	A-7
Advanced Graphics 1024	109958	114201-001	A-8
Advanced Graphics Memory	109959	114202-001	X
* ECG and VGC require system ROM E or later			
MISCELLANEOUS			
Serial/Parallel Interface	000570	106886-001	A-8
Serial/Parallel Interface	000990	106886-001	A-9
2400-Baud Int Modem	001070	112693-001	X

DP386

COMPAQ DESKPRO 386

FIXED DISK DRIVES

Drive Size	Drive Type	Inter-leave	Inte-grated	Min ROM	Spare Part No.	Controller Assy No.
40 MB ⁰	17	3:1	Y	F	108058-001	000815
70 MB	12	2:1	N	F	102932-001	WD1002WAH
130 MB ¹	25 ²	3:1	N	F	108080-001	WD1005WAH
	35 ²	1:1		F		WD1007AWAH
300 MB ³	38	1:1	N	H.8	113219-001	001091 001283 001472 ⁴ 001628

⁰ See page A-13 for dual 40-MB drive configuration information

¹ Comes formatted as type 35 for the WD1007AWAH controller. If used with the WD1005WAH controller (type 25) you must perform an unconditional format followed by a surface analysis using ADVANCED DIAGNOSTICS 5.04 or greater

² MS-DOS 3.1 or earlier supports type 25 only. MS-DOS 3.2 or later supports either type. Use type 25 if the application software supports only 17 sectors per track.

³ Used in Fixed Disk Expansion Unit. Requires MS-DOS 3.3 or later

⁴ Disable diskette circuitry when using as a fixed disk drive controller.

TAPE DRIVES

Drive Size	Spare Part No.	Tape Cartridge	Spare Part No.
40 MB	108081-001	40 MB (DC2000)	108142-001
135 MB	113218-001	135 MB (DC600 XTD)	113234-001
150/250 MB	115368-001	150 MB (DC600 XTD)	113234-001
		250 MB	115298-001

DISKETTE DRIVES

Size	Spare Part No.
360 KB	102928-001
1.2 MB	102775-001
1.44 MB*	113263-001

*Requires system ROM H.8 or later for use with MS-DOS and system ROM J.4 or later for use with MS OS/2 Version 1.1. Requires MS-DOS Version 3.31 Revision A if installed as drive B, and MS-DOS Version 3.31 Revision B if installed as drive A.

CABLE INFORMATION

Cable Function	Used With	Spare Part No.
Diskette/Tape Signal ¹	All Diskette Drives 40-MB Tape	101380-002
Mass Storage Power ¹	All Diskette, Tape & Fixed Disk Drives	101137-001
Tape Signal	135-MB Tape 150/250-MB Tape	113198-001
FDD Signal	70-MB FDD	100625-003 100625-004
		34 Pin 20 Pin
FDD Signal ²	Single 40-MB FDD Dual 40-MB FDD	108086-001 108087-001
FDD Signal ³	130-MB FDD	100625-005 100625-006
		34 Pin 20 Pin
External I/O ⁴	Expansion Unit	115810-001
Telephone Cable	Modem	112686-001

¹ Part of kits 102934-001 & 108146-001

³ Part of kit 108146-001

² Part of kits 100641-002 & 102394-001

⁴ Part of kit 108249-001

DP386

COMPAQ DESKPRO 386

BOARD JUMPER/SWITCH SETTINGS

SYSTEM BOARD (000401)

SW1 SETTINGS						Function
1	2	3	4	5	6	
ON						Reserved
	ON					80287 coprocessor installed
	OFF*					80287 coprocessor not installed
		ON				Coprocessor speed 4 MHz
		OFF*				Coprocessor speed 8 MHz
			ON*			CPU boot speed 16 MHz except when accessing diskette drive, then 8 MHz
			OFF			CPU boot speed 16 MHz (always)
				OFF		Reserved
					ON*	COMPAQ VDU, COMPAQ EGA, compatible EGA, RGBI, or VGC
					OFF	3rd-party monochrome (MDA only)

* Default

SYSTEM BOARD (000558)

SW1 SETTINGS								Function
1	2	3	4	5	6	7	8	
ON								Reserved
	ON							Coprocessor installed
	OFF*							No coprocessor installed
		ON						80287-3 or -6 co- processor speed 4 MHz
		OFF*						80287-8 coprocessor speed 8 MHz
			ON*					CPU boot speed 16 MHz except when accessing diskette drv, then 8 MHz
			OFF					CPU boot speed 16 MHz (always)
				OFF				Reserved
					ON*			COMPAQ VDU & EGA compatible EGA, RGBI or VGC
					OFF			3rd-party monochrome (MDA only)
						ON*		80287-3, -6, or -8 copro- cessor or no co- processor installed
						OFF		387-16 coprocessor
							ON	Reserved

* Default

DP386

COMPAQ DESKPRO 386

BOARD JUMPER/SWITCH SETTINGS

32-Bit System Memory Board (000413)

Jumper Setting	Function
E1 to E2, E4 to E5	256 KB base memory
E2 to E3, E4 to E5	512 KB base memory
E2 to E3, E5 to E6	640 KB base memory (default)
E7 to E8	Disables extended memory (default)
E8 to E9	Enables extended memory

CAUTION: DO NOT connect E3 to E4 or E6 to E7. System board damage may occur.

0.5 to 2 MB 16-Bit Memory Board (000458)

Jumper Settings	Base Address
1 to 2, 4 to 5	4 MB (default)
1 to 2, 5 to 6	6 MB
2 to 3, 4 to 5	10 MB
2 to 3, 5 to 6	12 MB

1- to 2-MB (000450) & 4- to 8-MB (000459) 32-Bit Memory Expansion Boards

J101 Setting	1- to 2-MB Board	4- to 8-MB Board
1 to 2	Enables second 1 MB of memory	Enables second 4 MB of memory
2 to 3 (default)	Disables second 1 MB of memory	Disables second 4 MB of memory

PROCESSOR/COPROCESSOR LOCATIONS

	000558 Sys Bd	000401 Sys Bd
Processor (386-16)	U78	U58
Coprocessor (387-16)	U60	N/A
Coprocessor (80287-3, -6, or -8)	U42	U39

DP386

COMPAQ DESKPRO 386 SYSTEM ROM INFORMATION

SYSTEM ROM LOCATIONS

000401 Sys Bd

000558 Sys Bd

U13 ODD

U15 ODD

U11 EVEN

U13 EVEN

SYSTEM ROM REVISIONS (Spare Part No. 108283-001)

Rev	PN on ODD ROM	PN on EVEN ROM
E	108284-001	108285-001
F	108327-001	108328-001
G	108327-002	108328-002
H 8	113269-008	113270-008
J 4	109591-001	109592-001
K 2	109591-003	109592-003
M 1	109591-004	109592-004
N 1	109591-005	109592-005

POWER SUPPLY

Spare Part No. 108065-001

BATTERY

Spare Part No. 102929-001

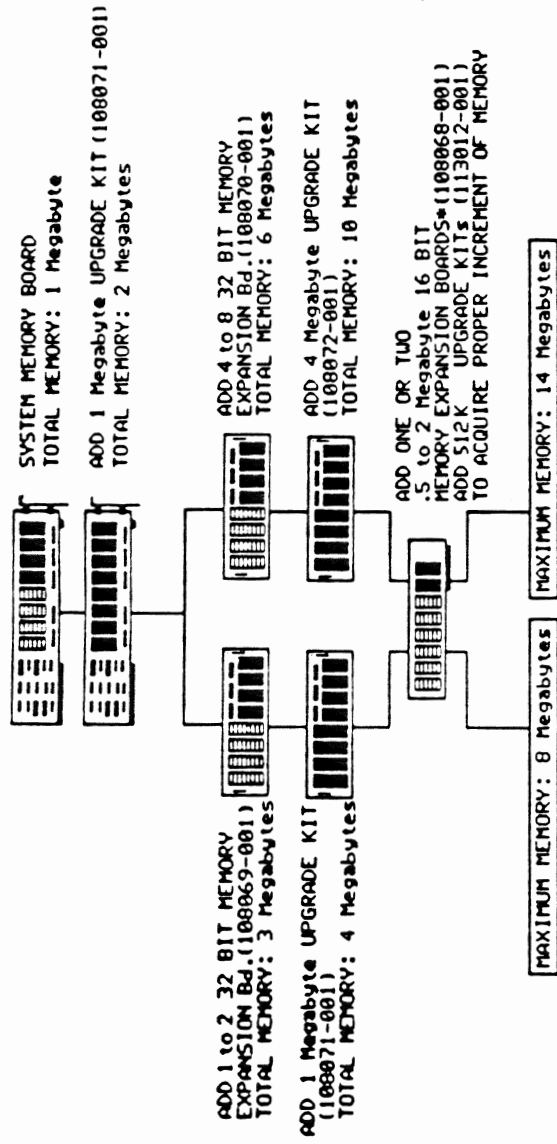

*Because this memory is only 16 data bits wide, any data or programs contained in the 16 bit memory will have slower access than 32 bit memory.

COMPAQ DESKPRO 386 MEMORY UPGRADE CHART

DP386N

COMPAQ DESKPRO 386N

BOARD COMPATIBILITY LIST

Product	Assy No.	Spare Part No.	Page
---------	----------	----------------	------

SYSTEM BOARDS

386SX System	001496	113922-001	100
--------------	--------	------------	-----

MEMORY BOARDS

Memory Expansion	001457	118739-001	X
4 MB Memory Module	118665-002	118741-001	X
1 MB Memory Module	118666-001	113911-001	X
2 MB Memory Module	118667-002	113923-001	X

MISCELLANEOUS

Serial/Parallel Interface	000570	106886-001	A-8
Serial/Parallel Interface	000990	106886-001	A-9
2400-Baud Int Modem	001070	112693-001	X
Backplane Board	001451	118742-001	X

FIXED DISK DRIVES

Drive Size	Drive Type	Inter-leave	Inter-grated	Min ROM	Spare Part No.	Controller Assy No.
20 MB	2	1:1	Y	A	113959-001	N/A
40 MB	22*	1:1	Y	A	113960-001	N/A
60 MB	55	1:1	Y	A	113961-001	N/A
120 MB	50	1:1	Y	A	113962-001	N/A

*May be drive type 22 or drive type 17

DISKETTE DRIVES

Size	Spare Part No.
1.2 MB	112566-001
1.44 MB	113958-001

CABLE INFORMATION

Cable Function	Used With	Spare Part No.
Diskette Signal	1.2 MB Diskette	113938-001
Diskette Power	1.2 MB Diskette & Fixed Disk Drive	113939-001
Diskette Signal/Power	1.44 MB Diskette	113930-001
Mass Storage Power	All FDD	113927-001
Mass Storage Signal	All FDD	113928-001

DP386N

COMPAQ DESKPRO 386N

BOARD JUMPER/SWITCH SETTINGS

SYSTEM BOARD (001496)

SWITCH	SETTING	FUNCTION
SW1-1	ON*	Enable Integrated VGA
SW1-1	OFF	Disable Integrated VGA
SW1-2	ON*	Enable SETUP
SW1-2	OFF	Disable SETUP
SW1-3	ON*	Enable external boot
SW1-3	OFF	Disable external boot
SW1-4	ON*	Enable power-on password
SW1-4	OFF	Disable power-on password
SW1-5	ON*	Reserved
SW1-6	ON*	Enable diskette write
SW1-6	OFF	Disable diskette write

* Default.

PROCESSOR/COPROCESSOR LOCATIONS

System Board 001496

Processor (386SX-16) Coprocessor (387SX-16)

Not field replaceable U58

SYSTEM ROM INFORMATION

SYSTEM ROM LOCATION

U13

SYSTEM ROM REVISIONS (Spare Part No. 118775-001)

Rev	PN on ROM
032790	113915-003
040590	113915-004
042590	113915-005
050390	113915-006
080290	113915-007

POWER SUPPLY

Spare Part No. 118743-001

BATTERY/CLOCK MODULE

Spare Part No. 107872-001

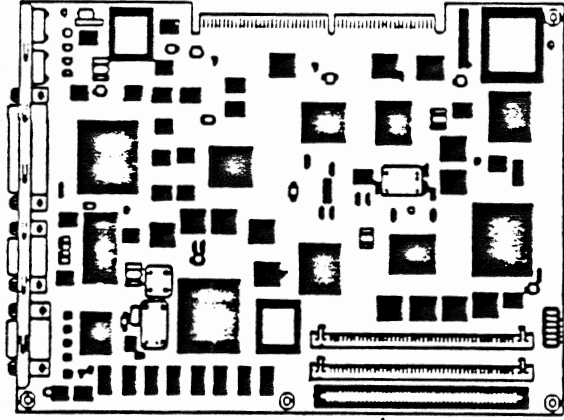

INSTALL MEMORY MODULES ON SYSTEM BOARD

INSTALL MEMORY EXPANSION BOARD ON SYSTEM BOARD

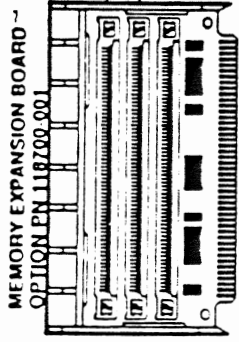

MEMORY EXPANSION BOARD
OPTION PN 118700-001

1-MB MEMORY MODULE
OPTION PN 118688-001



2-MB MEMORY MODULE
OPTION PN 118689-001



4-MB MEMORY MODULE
OPTION PN 118690-001



INSTALL MEMORY MODULES IN ANY COMBINATION AND ORDER IN THE TOP TWO SLOTS ON THE MEMORY EXPANSION BOARD

MAXIMUM MEMORY: 16 MB

COMPAQ DESKPRO 386N MEMORY UPGRADE CHART

DP386s

COMPAQ DESKPRO 386s

BOARD COMPATIBILITY LIST

Product	Assy No.	Spare Part No.	Page
SYSTEM BOARDS			
386SX System	000954*/001145 001148**/001157 001644	112572-001	105
* Comes with VGC Board (Assy No. 001059) mounted on system board			
** Comes with 1-MB Memory Module (Assy No. 000981 or 001076) mounted on system board.			
MEMORY BOARDS			
1-MB 16-MHz Mem Exp	000966	112522-001	X
4-MB 16-MHz Mem Exp	000969	112521-001	X
1-MB Mem Module	000981 001076-003/004/007/008 001151-002 001256-003/004/007/008 001259-002	112519-001	X
4 MB Mem Module	000993/001166-002	112520-001	X
CONTROLLER BOARDS			
Tape Adapter	000774	113259-001	A-3
ESDI External 300/600	001091	115839-001	A-3
15 MHz ESDI Cntrl	001283/001628	115188-001	A-4
ESDI/Diskette Cntrl	001472	115374-001	A-4
VIDEO BOARDS			
Advanced Graphics 1024	109958	114201-001	A-8
Advanced Graphics Memory	109959	114202-001	X
VGA Pass-Through	001430	114241-001	X
MISCELLANEOUS			
Serial/Parallel Interface	000570	106886-001	A-8
Serial/Parallel Interface	000990	106886-001	A-9
2400-Baud Int Modem	001070	112693-001	X

DP386s

COMPAQ DESKPRO 386s

FIXED DISK DRIVES

Drive Size	Drive Type	Inter-leave	Inte-grated	Min ROM	Spare Part No.	Controller Assy No.
20 MB*	2	1:1	Y	M.3	114485-001	N/A
20 MB*	2	3:1	Y	M.3	112527-001	N/A
40 MB	22	1:1	Y	M.3	112526-001	N/A
40 MB*	43	1:1	Y	M.3	112526-001	N/A
84 MB	27	1:1	Y	M.3	112438-001	N/A
110 MB*	33	1:1	Y	M.3	112525-001	N/A
300 MB ¹	38	1:1	N	M.3	113219-001	001091 001283/001628 001472 ²
320 MB	28	1:1	N	M.3	115182-001	001283/001628

* See page A-13 for single and dual fixed disk drive switch settings and configuration.

¹ Used in Fixed Disk Expansion Unit. Requires MS-DOS 3.3 or later.

² Disable diskette circuitry when using as a fixed disk drive controller.

TAPE DRIVES

Drive Size	Spare Part No.	Tape Cartridge	Spare Part No.
40/60 MB	112524-001	40 MB (DC2000)	108142-001
		60 MB	122086-001
80/120 MB	122087-001	80 MB	116966-001
		120 MB	116967-001
135 MB	112523-001	135 MB (DC600 XTD)	113234-001
150/250 MB	115220-001	150 MB (DC600 XTD)	113234-001
		250 MB	115298-001

DISKETTE DRIVES

Size	Spare Part No.
360 KB	112567-001
1.2 MB	112566-001
1.44 MB*	112565-001

* Requires MS-DOS Version 3.31 Revision A if installed as drive B, and MS-DOS Version 3.31 Revision B if installed as drive A.

CABLE INFORMATION

Cable Function	Used With	Spare Part No.
Diskette/Tape Signal	All Diskette Drives	113594-001
	40/60-MB Tape	
Mass Storage Power	All Diskette & Tape Drives	113596-001
Mass Storage Power	20-, 40-, 84- & 110-MB FDD - Drive C	101741-001
Mass Storage Power	20-, 40-, 84-, & 110-MB FDD - Drive D	101741-004
Tape Signal	135- & 150/250 MB Tape Drives	113198-002
FDD Signal	20-, 40-, 84-, & 110-MB FDD - Drive C	113595-001
FDD Signal	20-, 40-, 84-, & 110-MB FDD - Drive D	112528-001
Mass Storage Power	320-MB FDD	115215-001
Mass Storage Signal	320-MB FDD	100625-006
		115197-001
External I/O	Expansion Unit	115810-001
Telephone Cable	Modem	112666-001
VGA Pass-Through	Adv Graphics	114229-001

DP386s

COMPAQ DESKPRO 386s

BOARD JUMPER/SWITCH SETTINGS

SYSTEM BOARD (000954, 001145, 001148, 001157 & 001644)

SW1 SETTINGS

1	2	3	4	5	6	Function
ON*						Enable fail-safe timer
OFF						Disable fail-safe timer
	ON					387SX coproc processor installed
	OFF*					387SX coprocessor not installed
		OFF				Reserved
			ON*			CPU boot speed 16 MHz except when accessing diskette drive, then 8 MHz
			OFF			CPU boot speed 16 MHz (always)
				OFF		Reserved
					ON*	EGA, RGBI, or VGC
					OFF	3rd-party monochrome (MDA only)

* Default

SYSTEM BOARD (000954, 001145, 001148, 001157 & 001644)

SW2 SETTINGS

1	2	3	4	5	6	7	8	Function
OFF*								Primary diskette & fixed disk drive address select (3FX & 1FX)
ON								Secondary diskette & fixed disk drive address select (37X & 17X)
	OFF*							Enable power-on password
	ON							Disable power-on password
		OFF						Enable fixed disk drive
		ON						Disable fixed disk drive
			OFF*	OFF*				Serial interface COM1 IRQ4
			ON	OFF				Serial interface COM2 IRQ3
			ON	ON				Disable serial interface
			OFF	ON				Reserved
					ON*	OFF*		Select printer interface LPT1 (3BX)
					OFF	ON		Select printer interface LPT2 (37X)
					ON	ON		Disable printer interface
					OFF	OFF		Reserved
							OFF*	Enable integrated VGC
							ON	Disable integrated VGC

* Default

Continued

DP386s

COMPAQ DESKPRO 386s

BOARD JUMPER/SWITCH SETTINGS

SYSTEM BOARD (000954, 001145, 001148, 001157 & 001644)

SW3 Settings

1	2	Function
ON	ON	640 KB base memory limit (default)
ON	OFF	512 KB base memory limit
OFF	OFF	256 KB base memory limit
OFF	ON	Reserved

SW3 Settings (continued)

3	4	5	6	Mem Exp	Memory Mod A	Memory Mod B	Total Mem
ON	ON	ON	ON		1 MB on system board only (default)		
ON	ON	ON	OFF	1 MB			2 MB
ON	ON	OFF	ON	1 MB	1 MB		3 MB
ON	ON	OFF	OFF	1 MB	1 MB	1 MB	4 MB
OFF	ON	ON	OFF	4 MB			5 MB
ON	OFF	OFF	ON	1 MB	4 MB		6 MB
ON	OFF	ON	ON	1 MB	1 MB	4 MB	7 MB
OFF	ON	OFF	ON	4 MB	4 MB		9 MB
ON	OFF	OFF	OFF	1 MB	4 MB	4 MB	10 MB
OFF	ON	OFF	OFF	4 MB	4 MB	4 MB	13 MB

SYSTEM BOARD (000954)

Jumper	Setting	Function
E4	1 - 2	Enable IRQ12 from bus, disable pointing device
E4	2 - 3*	Enable pointing device interface
E3	Jumper on	Reserved
E2	Jumper on	Reserved

* Pins closest to U64

DP386s

COMPAQ DESKPRO 386s

PROCESSOR/COPROCESSOR LOCATIONS

System Board Assy	Processor (386SX-16)	Coprocessor (387SX-16)
000954, 001145	U80	U104
001148, 001157	U97	U115

SYSTEM ROM INFORMATION

SYSTEM ROM LOCATIONS

System Board Assy	System ROM	System Option ROM
000954, 001145	U81 ODD U67 EVEN	
001148, 001157	U90 ODD U74 EVEN	U47 ODD U40 EVEN

SYSTEM ROM REVISIONS (Spare Part No. 112564-001)

Rev	PN on ODD ROM	PN on EVEN ROM
M.3	112593-008	112594-008
N.2	112593-009	112594-009
N.4	112593-010	112594-010
N.5	112593-011	112594-011
P.3	112593-012	112594-012

POWER SUPPLY

Spare Part No. 112570-001

BATTERY

Spare Part No. 112654-001

BATTERY/CLOCK MODULE

Spare Part No. 107872-001
(Used on System Board 001157)

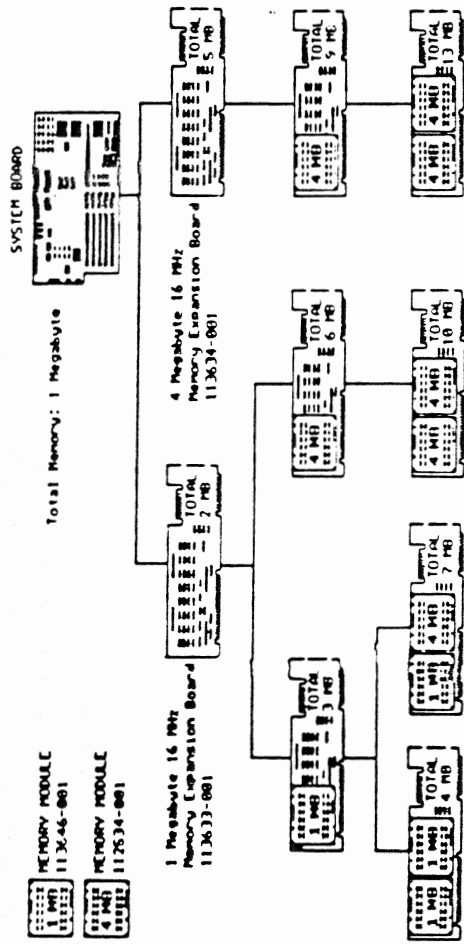

COMPAQ DESKPRO 386s MEMORY UPGRADE CHART

DP386/20

COMPAQ DESKPRO 386/20

BOARD COMPATIBILITY LIST

Product	Assy No.	Spare Part No.	Page
SYSTEM BOARDS			
386 System	000749	113223-001	111
MEMORY BOARDS			
1MB System Mem	000752/001103	113224-001	X
4MB System Mem	000765	113222-001	X
4MB Memory Module	000758/000993/ 001166-001/002	113226-001	X
1MB Memory Module	000762/000981/ 001076/001151-001 001256/001259	113225-001	X
CONTROLLER BOARDS			
ESDI 180/300	WD1007AWAH	113265-001	A-1
Tape Adapter	000774	113259-001	A-3
Multipurpose Fixed Disk	000815	113446-001	A-3
ESDI External 300/600	001091	115839-001	A-3
15 MHz ESDI Cntrl	001283/001628	115188-001	A-4
ESDI/Diskette Cntrl	001472	115374-001	A-4
VIDEO BOARDS			
Enh Color Graphics*	000410	106373-001	A-5
Enh Color Graphics*	000471	109196-001	A-5
VDU	000031/000160/ 000345	101340-001	A-5
VDU	000525	101340-001	A-7
VGC*	000806/001241 109360	109253-001	A-7
Advanced Graphics 1024	109958	114201-001	A-8
Advanced Graphics Memory	109959	114202-001	X
* ECG and VGC require system ROM H or later			
MISCELLANEOUS			
Serial/Parallel Interface	000570	106886-001	A-8
Serial/Parallel Interface	000990	106886-001	A-9
Weitek/387-20	000777	113267-001	X
2400-Baud Int Modem	001070	112693-001	X

DP386/20

COMPAQ DESKPRO 386/20

FIXED DISK DRIVES

Drive Size	Drive Type	Inter-leave	Inte-grated	Min ROM	Spare Part No.	Controller Assy No.
60 MB ^{1*}	47	2:1	Y	H.8	113217-001	000815
130 MB	35	1:1	N	H.8	108080-001	WD1007AWAH
300 MB ¹	38	1:1	N	H.8	113219-001	WD1007AWAH
300 MB ²	38	1:1	N	H.8	113219-001	001091 001283 ₃ 001472 ₃ 001628

* See page A-13 for dual 60-MB fixed disk drive jumper settings and configuration information.

¹ Requires MS-DOS 3.3 or later.

² Used in Fixed Disk Expansion Unit. Requires MS-DOS 3.3 or later.

³ Disable diskette circuitry when using as fixed disk drive controller.

TAPE DRIVES

Drive Size	Spare Part No.	Tape Cartridge	Spare Part No.
40 MB	108081-001	40 MB (DC 2000)	108142-001
135 MB	113218-001	135 MB (DC 600 XTD)	113234-001
150/250 MB	115368-001	150 MB (DC 600 XTD)	113234-001
		250 MB	115298-001

DISKETTE DRIVES

Size	Spare Part No.
360 KB	102928-001
1.2 MB	102775-001
1.44 MB*	113263-001

* Requires MS-DOS Version 3.31 Revision A if installed as drive B, and MS-DOS Version 3.31 Revision B if installed as drive A.

CABLE INFORMATION

Cable Function	Used With	Spare Part No.
Diskette/Tape Signal ¹	All Diskette Drives 40-MB Tape	101380-002
Tape Signal	135- & 150/250 MB Tape Drives	113198-001 8 In.
Mass Storage Power ¹	All Diskette, Tape & Fixed Disk Drives	101137-001
FDD Signal ²	60-MB FDD	108086-001
FDD Signal	60-MB FDD (Dual Drives)	108087-001
FDD Signal ³	130-MB FDD 300-MB FDD	100625-005 34 Pin 100625-006 20 Pin
External I/O	Expansion Unit	115810-001
Telephone Cable	Modem	112666-001

¹ Part of kits 102934-001 & 108146-001 ³ Part of kit 108249-001

² Part of kit 108146-001

DP386/20

COMPAQ DESKPRO 386/20

BOARD JUMPER/SWITCH SETTINGS

SYSTEM BOARD (000749)

SW1 SETTINGS

1	2	3	4	5	6	7	8	Function
ON								Reserved
	ON							387 coprocessor installed on system board or Weitek board with 387
	OFF*							387 coprocessor not installed or Weitek board without 387
		OFF						Reserved
			ON*					CPU boot speed 20 MHz except 8 MHz when accessing diskette drive
			OFF					CPU boot speed 20 MHz
				OFF				Reserved
					ON*			COMPAQ VDU & EGA, compatible EGA, RGBI or VGC
						OFF		3rd-party monochrome (MDA only)
						OFF	OFF	256 KB base memory
						OFF	ON	512 KB base memory
						ON*	ON*	640 KB base memory

* Default

PROCESSOR/COPROCESSOR LOCATIONS

Processor (386-20)	Coprocessor (387 - 20)
U52	U60

SYSTEM ROM INFORMATION

SYSTEM ROM LOCATIONS

U9 ODD
U8 EVEN

SYSTEM ROM REVISIONS (Spare Part No. 108283-001)

Rev	PN on ODD ROM	PN on EVEN ROM
H.8	113269-008	113270-008
J.4	109591-001	109592-001
K.2	109591-003	109592-003
M.1	109591-004	109592-004
N.1	109591-005	109592-005











POWER SUPPLY

Spare Part No. 108065-001

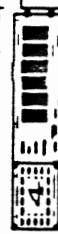
BATTERY











Spare Part No. 102929-001

1 MEGABYTE BASE MEMORY BOARD

TOTAL MEMORY: 1 Megabyte	
TOTAL MEMORY: 2 Megabytes	
TOTAL MEMORY: 3 Megabytes	
TOTAL MEMORY: 4 Megabytes	
TOTAL MEMORY: 5 Megabytes	
TOTAL MEMORY: 6 Megabytes	
TOTAL MEMORY: 7 Megabytes	
TOTAL MEMORY: 9 Megabytes	
TOTAL MEMORY: 10 Megabytes	
TOTAL MEMORY: 13 Megabytes	

 1 MEGABYTE MEMORY MODULE - 113131-001

4 MEGABYTE BASE MEMORY BOARD (113190-001)

TOTAL MEMORY: 4 Megabytes	
TOTAL MEMORY: 5 Megabytes	
TOTAL MEMORY: 6 Megabytes	
TOTAL MEMORY: 7 Megabyte	
TOTAL MEMORY: 8 Megabytes	
TOTAL MEMORY: 9 Megabytes	
TOTAL MEMORY: 10 Megabytes	
TOTAL MEMORY: 12 Megabytes	
TOTAL MEMORY: 13 Megabytes	
TOTAL MEMORY: 16 Megabytes	

 4 MEGABYTE MEMORY MODULE - 113132-001

COMPAQ DESKPRO 386/20 MEMORY UPGRADE CHART

DP386/20e

COMPAQ DESKPRO 386/20e

BOARD COMPATIBILITY LIST

Product	Assy No.	Spare Part No.	Page
SYSTEM BOARDS			
386/20e System	000935/001196/ 001316/001625	112571-001	115/116
MEMORY BOARDS			
4MB Memory Module	000758/000993/ 001166-001/002	113226-001	X
1MB Memory Module	000762/000981/ 001076/001151-001 001256/001259	113225-001	X
1MB 32-Bit Memory	000960	112518-001	X
4MB 32-Bit Memory	000963	112517-001	X
CONTROLLER BOARDS			
Tape Adapter	000774	113259-001	A-3
ESDI External 300/600	001091	115839-001	A-3
15 MHz ESDI Cntrl	001283/001628	115188-001	A-4
ESDI/Diskette Cntrl	001472	115374-001	A-4
VIDEO BOARDS			
Advanced Graphics 1024	109958	114201-001	A-8
Advanced Graphics Memory	109959	114202-001	X
VGA Pass-Through	001430	114241-001	X
MISCELLANEOUS			
Serial/Parallel Interface	000570	106886-001	A-8
Serial/Parallel Interface	000990	106880-001	A-9
2400-Baud Int Modem	001070	112693-001	X

DP386/20e

COMPAQ DESKPRO 386/20e

FIXED DISK DRIVES

Drive Size	Drive Type	Inter-leave	Inte-grated	Min ROM	Spare Part No.	Controller Assy No.
20 MB*	2	1:1	Y	M.2	114465-001	N/A
20 MB*	2	3:1	Y	M.2	112527-001	N/A
40 MB*	22	1:1	Y	M.2	112526-001	N/A
40 MB*	43	1:1	Y	M.2	112526-001	N/A
84 MB	27	1:1	Y	M.2	112438-001	N/A
110 MB*	33	1:1	Y	M.2	112525-001	N/A
300 MB ¹	38	1:1	N	M.4	113219-001	001091 001283 001472 001828
320 MB	28	1:1	N	N.2	115182-001	001283 001528

* See page A-13 for single and dual fixed disk drive switch settings and configuration.

¹ Used in Fixed Disk Expansion Unit. Requires MS-DOS 3.3 or later.

² Disable diskette circuitry when using as a fixed disk drive controller.

TAPE DRIVES

Drive Size	Spare Part No.	Tape Cartridge	Spare Part No.
40/60 MB	112524-001	40 MB (DC 2000)	108142-001
		60 MB	122086-001
135 MB	112523-001	135 MB (DC 600 XTD)	113234-001
80/120 MB	122087-001	80 MB	116966-001
		120 MB	116967-001
150/250 MB	115220-001	150 MB (DC 600 XTD)	113234-001
		250 MB	115298-001

DISKETTE DRIVES

Size	Spare Part No.
360 KB	112567-001
1.2 MB	112566-001
1.44 MB*	112565-001

* Requires MS-DOS Version 3.31 Revision A if installed as drive B, and MS-DOS Version 3.31 Revision B if installed as drive A.

Rem 112565-001

DP386/20e

COMPAQ DESKPRO 386/20e

CABLE INFORMATION

Cable Function	Used With	Spare Part No.	
Diskette/Tape Signal	All Diskette Drives 40/60-MB Tape	113594-001	
Mass Storage Power	All Diskette & Tape Drives	113596-001	
Mass Storage Power	20-, 40-, 84-, & 110-MB FDD - Drive C	101741-001	
Mass Storage Power	20-, 40-, 84-, & 110-MB FDD - Drive D	101741-004	15 In.
Tape Signal	135-, 80/120-, & 150/250-MB Tape Drives	113198-002	
FDD Signal	20-, 40-, 84-, & 110-MB FDD - Drive C	113595-001	
FDD Signal	20-, 40-, 84-, & 110-MB FDD - Drive D	112528-001	
Mass Storage Power	320-MB FDD	115215-001	
Mass Storage Signal	320-MB FDD	100625-006 115197-001	20-Pin 34-Pin
External I/O	Expansion Unit	115810-001	
Telephone Cable	Modem	112666-001	
VGA Pass-Through	Adv Graphics	114229-001	

BOARD JUMPER/SWITCH SETTINGS

SYSTEM BOARD (000935, 001196, & 001316)

SW1 SETTINGS

1	2	3	4	5	6	7	8	Function
ON*								Enable fail-safe timer
OFF								Disable fail-safe timer
	ON							387 coprocessor installed
	OFF*							387 coprocessor not installed/Weitek installed
		ON						Disable memory caching in 12 thru 16-MB range
		OFF						Enable memory caching in 12 thru 16-MB range
			ON*					CPU boot speed 20 MHz except 8 MHz when accessing diskette drive
			OFF					CPU boot speed 20 MHz
				OFF				Reserved
					ON*			EGA, RGBI, or VGC
					OFF			3rd-party monochrome (MDA only)
						OFF	OFF	256 KB base memory
						ON	OFF	512 KB base memory
						ON	ON	640 KB base memory
						OFF	ON	Reserved

* Default

Continued

DP386/20e

COMPAQ DESKPRO 386/20e

BOARD JUMPER/SWITCH SETTINGS

SYSTEM BOARD (000935, 001196, & 001316)

SW2 SETTINGS

1	2	3	4	5	6	7	8	Function
OFF*								Primary diskette & fixed disk drive address select (3FX & 1FX)
ON								Secondary diskette & fixed disk drive address select (37X & 17X)
	OFF*							Enable power-on password
	ON							Disable power-on password
		OFF*						Enable integrated fixed disk drive controller
		ON						Disable integrated fixed disk drive controller
			OFF*	OFF*				Serial interface COM1 IRQ4
			ON	OFF				Serial interface COM2 IRQ3
			ON	ON				Disable serial interface
			OFF	ON				Reserved
					ON*	OFF*		Select printer interface LPT1 (3BX)
					OFF	ON		Select printer interface LPT2 (37X)
					ON	ON		Disable printer interface
					OFF	OFF		Reserved
							OFF*	Enable integrated VGC
							ON	Disable integrated VGC

Jumper	Setting	Function
E4	1 - 2	Enable IRQ12 from bus, disable pointing device
E4	2 - 3*	Enable pointing device interface
E10	1 - 2*	8-bit video ROM
E10	2 - 3	16-bit video ROM

* Default

SYSTEM BOARD (001625)

Switch	Setting	Function
S1	ON*	Enable integrated VGA
S1	OFF	Disable integrated VGA
S2	ON	Disable Power-On Password
S2	OFF*	Enable Power-On Password

DP386/20e

COMPAQ DESKPRO 386/20e

PROCESSOR/COPROCESSOR LOCATIONS

Processor (386-20)	Coprocessor (387-20)
U154	U155
<u>Weitek 3167 Coprocessor (Spare Part No. 115517-001)</u>	
U155	

SYSTEM ROM INFORMATION

<u>SYSTEM ROM LOCATIONS (000935, 001196, 001316)</u>	
U119 ODD	
U135 EVEN	

<u>SYSTEM ROM LOCATIONS (001625)</u>	
U119 ODD	
U141 EVEN	

<u>SYSTEM ROM REVISIONS (Spare Part No. 112694-001)</u>		
Rev	PN on ODD ROM	PN on EVEN ROM
M.2	112673-003	112674-003
M.4	112673-004	112674-004
N.2	112673-005	112674-005
N.3	112673-006	112674-006
P.6	122095-001	122096-001
R.1	122095-002	122096-002

POWER SUPPLY

Spare Part No. 112570-001

BATTERY

Spare Part No. 112654-001

BATTERY/CLOCK MODULE

Spare Part No. 107872-001
(Used on System Board 001496)

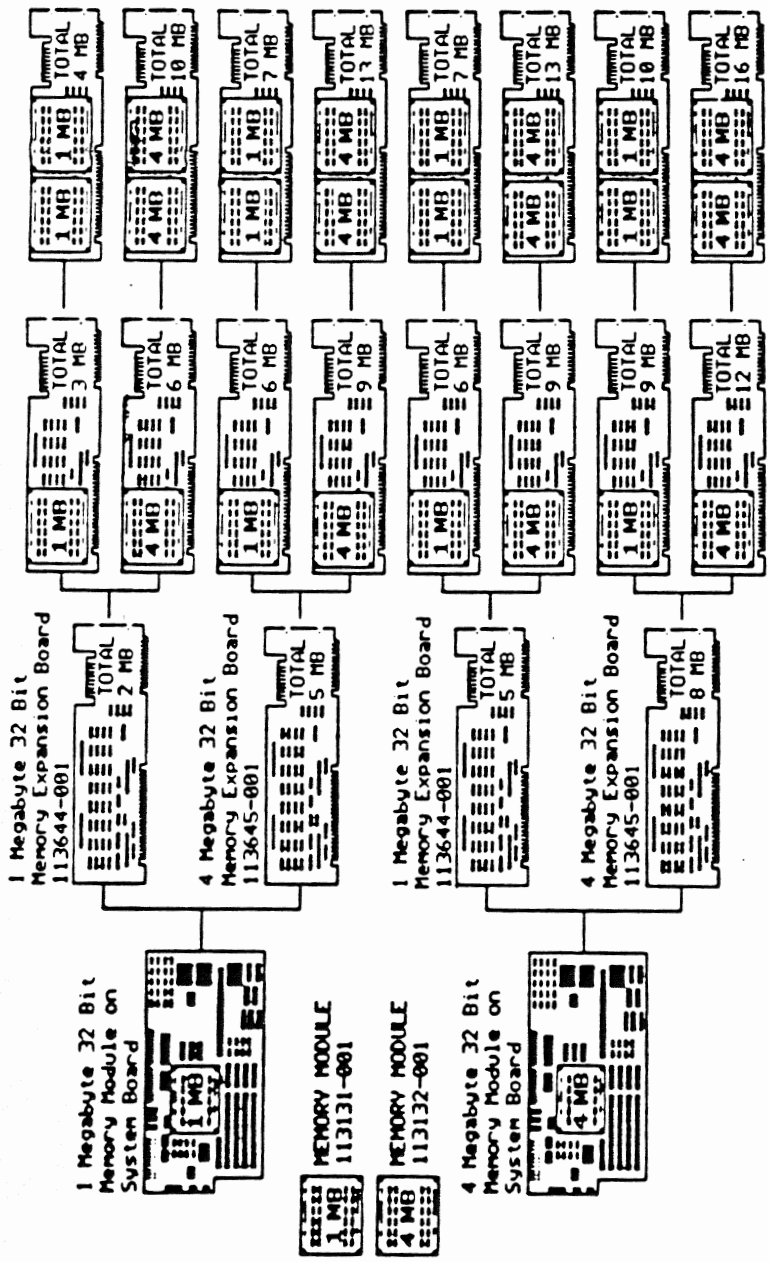

COMPAQ DESKPRO 386/20e MEMORY UPGRADE CHART

DP386s/20

COMPAQ DESKPRO 386s/20

BOARD COMPATIBILITY LIST

Product	Assy No.	Spare Part No.	Page
---------	----------	-------------------	------

SYSTEM BOARDS

386SX System	001421	122131-001	121
--------------	--------	------------	-----

MEMORY BOARDS

4 MB Memory Module	118665-002	118741-001	X
1 MB Memory Module	118666-002	118740-001	X
2 MB Memory Module	118667-002	113923-001	X

CONTROLLER BOARDS

Tape Adapter	000774	113259-001	A-3
ESDI External 300/600	001091	115839-001	A-3
15 MHz ESDI Cntrl	001628	121667-001	A-4

VIDEO BOARDS

Advanced Graphics 1024	109958	114201-001	A-8
Advanced Graphics Memory	109959	114202-001	X
VGA Pass-Through	001430	114241-001	X

MISCELLANEOUS

Serial/Parallel Interface	000570	106886-001	A-8
Serial/Parallel Interface	000990	106886-001	A-9
2400-Baud Int Modem	001070	112693-001	X

DP386s/20

COMPAQ DESKPRO 386s/20

FIXED DISK DRIVES

Drive Size	Drive Type	Inter-leave	Inter-grated	Min ROM	Spare Part No.	Controller Assy No.
40 MB*	22	1:1	Y	A	112526-001	N/A
60 MB	55	1:1	Y	A	122079-001	N/A
120 MB	50	1:1	Y	A	122080-001	N/A
210 MB	51	1:1	Y	A	124013-001	N/A
300 MB ¹	38	1:1	N	A	113216-001	001628

* See page A-13 for single and dual fixed disk drive switch settings and configuration.

¹ Used in Fixed Disk Expansion Unit. Requires MS-DOS 3.3 or later.

NOTE: A 1st Fixed Disk Drive requires a rear dual drive bracket, Spare Part No. 122169-001

TAPE DRIVES

Drive Size	Spare Part No.	Tape Cartridge	Spare Part No.
40/60 MB	112524-001	40 MB (DC 2000)	108142-001
		60 MB	122086-001
80/120 MB	122087-001	80 MB	116966-001
		120 MB	116967-001
150/250 MB	115220-001	150 MB (DC 600 XTD)	113234-001
		250 MB	115298-001

DISKETTE DRIVES

Size	Spare Part No.
360 KB	112567-001
1.2 MB	112566-001
1.44 MB*	122392-001

* Requires MS-DOS Version 3.31 Revision A if installed as drive B, and MS-DOS Version 3.31 Revision B if installed as drive A.

DP386s/20

COMPAQ DESKPRO 386s/20

CABLE INFORMATION

Cable Function	Used With	Spare Part No.	
Diskette/Tape Signal	All Diskette Drives 40/60-MB Tape	113594-001	34 Pins
Diskette Signal/Power	1.44-MB Diskette	122158-001	
Mass Storage Power	Diskette & Tape Drives	122157-001	
Mass Storage Power	Single FDD	122156-001	6 In.
Mass Storage Power	Dual FDD	101741-004	
Tape Signal	80-/120- & 150-/250-MB Tape Drives	113198-002	
FDD Signal	FDD - Drive C	124006-001	40 Pins
FDD Signal	FDD - Drive D	112528-001	40 Pins
External I/O	Expansion Unit	130844-001	
Telephone Cable	Modem	112666-001	
VGA Pass-Through	Adv Graphics	114229-001	

BOARD JUMPER/SWITCH SETTINGS

SYSTEM BOARD (001421)

SWITCH	SETTING	FUNCTION
S1	ON*	Enable Integrated VGA
S1	OFF	Disable Integrated VGA
S2	ON*	Enable Power-On Password
S2	OFF	Disable Power-On Password

* Default

DP386s/20

COMPAQ DESKPRO 386s/20

PROCESSOR/COPROCESSOR LOCATIONS

Processor (386SX-20)	Coprocessor (387SX-20)
U26	U115

SYSTEM ROM INFORMATION

SYSTEM ROM LOCATION
U100

SYSTEM ROM REVISIONS (Spare Part No. 122171-001)	
Rev	PN on ROM
042590	122134-003

POWER SUPPLY

Spare Part No. 112570-001

BATTERY/CLOCK MODULE

Spare Part No. 107872-001

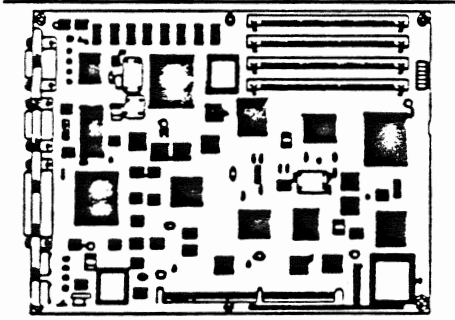

1-MB MEMORY MODULE
OPTION PN 118688-001



2-MB MEMORY MODULE
OPTION PN 118689-001



4-MB MEMORY MODULE
OPTION PN 118690-001



INSTALL ANY MEMORY MODULE IN
SLOT J1 ON THE SYSTEM BOARD.
THEN INSTALL MEMORY MODULES IN
ANY COMBINATION AND IN ANY
ORDER IN THE REMAINING SLOTS.

MAXIMUM MEMORY: 16 MEGABYTES

COMPAQ DESKPRO 386s/20 MEMORY UPGRADE CHART

DP386/25

COMPAQ DESKPRO 386/25

BOARD COMPATIBILITY LIST

Product	Assy No.	Spare Part No.	Page
SYSTEM BOARDS			
386 System	000944/001056/ 001069/001118	115526-001	127
MEMORY BOARDS			
1MB System Mem	000752/001103	113224-001	X
4MB System Mem	000765	113222-001	X
4MB Memory Module	000758/000993/ 001166-001/002	113226-001	X
1MB Memory Module	000762/000981/ 001076/001151-001 001256/001259/	113225-001	X
CONTROLLER BOARDS			
Tape Adapter	000774	113259-001	A-3
Multipurpose Fixed Disk	000957	115511-001	A-3
Multipurpose ESDI	000996	115519-001	128
ESDI External 300/600	001091	115839-001	A-3
15 MHz ESDI Cntrl	001283/001628	115188-001	A-4
ESDI/Diskette Cntrl	001472	115374-001	A-4
VIDEO BOARDS			
VDU	000031/000160/ 000345	101340-001	A-5
VDU	000525	101340-001	A-7
VGC*	000806/001241 109360	109253-001	A-7
Advanced Graphics 1024	109958	114201-001	A-8
Advanced Graphics Memory	109959	114202-001	X
* VGC requires system ROM K.2 or later			
MISCELLANEOUS			
Serial/Parallel Interface	000570	106886-001	A-8
Serial/Parallel Interface	000990	106886-001	A-9
2400-Baud Int. Modem	001070	112893-001	X

DP386/25

COMPAQ DESKPRO 386/25

FIXED DISK DRIVES

Drive Size	Drive Type	Inter-leave	Inte-grated	Min ROM	Spare Part No.	Controller Assy No.
60 MB ^{1*}	47	2:1	Y	K.2	113217-001	000957
60 MB*	47	1:1	Y	K.2	115649-001	000957
84 MB	27	1:1	Y	K.2	115668-001	000957
110 MB*	33	1:1	Y	K.2	115579-001	000957
300 MB ¹	38	1:1	N	K.2	113219-001	000998
650 MB ²	49	1:1	N	N.1	115181-001	001283, 001472, 001628
300 MB ²	38	1:1	N	K.2	113219-001	001091, 001283, 001472, 001628

* See page A-13 for dual fixed disk drive jumper settings and configuration information.

¹ Requires MS-DOS 3.3 or later.

² Used in Fixed Disk Expansion Unit. Requires MS-DOS 3.3 or later.

³ Disable diskette circuitry when using as a fixed disk drive controller.

TAPE DRIVES

Drive Size	Spare Part No.	Tape Cartridge	Spare Part No.
40 MB	108081-001	40 MB (DC 2000)	108142-001
135 MB	113218-001	135 MB (DC 600 XTD)	113234-001
150/250 MB	115368-001	150 MB (DC 800 XTD)	113234-001
		250 MB	115298-001

DISKETTE DRIVES

Size	Spare Part No.
360 KB	102928-001
1.2 MB	102775-001
1.44 MB*	113263-001

*Requires MS-DOS Version 3.31 Revision A if installed as drive B, and MS-DOS Version 3.31 Revision B if installed as drive A.

DP386/25

COMPAQ DESKPRO 386/25

CABLE INFORMATION

Cable Function	Used With	Spare Part No.	
Diskette/Tape Signal ¹	All Diskette Drives 40-MB Tape	101380-002	
Tape Signal	135- & 150/250-MB Tape Drives	113198-001	
Mass Storage Power ¹	All Diskette, Tape & Fixed Disk Drives	101137-001	
FDD Signal ²	60-MB FDD 60-MB 1:1 FDD 84- & 110-MB FDD	108086-001	
FDD Signal (Dual Drives)	60-MB FDD 60-MB 1:1 FDD 84- & 110-MB FDD	108087-001	
FDD Signal ³	300-MB FDD 650-MB FDD	100625-005 100625-006	34 Pin 20 Pin
External I/O	Expansion Unit	115810-001	
Telephone Cable	Modem	112666-001	

¹ Part of kits 102934-001 & 108146-001 ³ Part of kit 108249-001

² Part of kit 108146-001

BOARD JUMPER/SWITCH SETTINGS

SYSTEM BOARD (000944, 001056, 001069, & 001118)

SW1 SETTINGS

1	2	3	4	5	6	7	8	Function
ON								Reserved
	ON							387 coprocessor installed
	OFF*							387 coprocessor not installed
		ON						Cachable mem 0 - 12MB
		OFF*						Cachable mem 0 - 16MB
			ON*					CPU boot speed 25 MHz except 8 MHz when accessing diskette drive
			OFF					CPU boot speed 25 MHz
				OFF				Reserved
					ON*			COMPAQ VDU, EGA, RGBI or VGC
					OFF			3rd-party monochrome (MDA only)
						OFF	OFF	256 KB base memory
						OFF	ON	512 KB base memory
						ON*	ON*	640 KB base memory

* Default

E14 Setting	Location	Function
1 - 2*	Pins closest to 50-MHz crystal	25-MHz processor speed
2 - 3	Pins closest to 48-MHz crystal	24-MHz processor speed

*Default

DP386/25

COMPAQ DESKPRO 386/25

BOARD JUMPER/SWITCH SETTINGS (Cont'd)

MULTIPURPOSE ESDI FIXED DISK DRIVE CONTROLLER BOARD
(000996)

SW500 Settings

1	2	3	4	5	6	Function
OFF*						Primary diskette & fixed disk drive address select (3FX & 1FX)
ON						Secondary diskette & fixed disk drive address select (37X & 17X)
	OFF					Enable fixed disk drive
	ON					Disable fixed disk drive
		OFF*	OFF*			Serial Interface COM1 IRQ4
		ON	OFF			Serial Interface COM2 IRQ3
		ON	ON			Disable serial interface
				OFF	ON	Select printer interface LPT1
				ON	OFF	Select printer interface LPT2
				OFF	OFF	Select printer interface LPT3
				ON	ON	Disable printer interface

*Default

Jumper Settings

Jumper	Setting	Function
J1	1-2	ESDI = IRQ12
	3-4	ESDI = IRQ14
	5-6	ESDI = IRQ15
J2	1-2	Printer = IRQ7
	3-4	Printer = IRQ5

DP386/25

COMPAQ DESKPRO 386/25

PROCESSOR/COPROCESSOR LOCATIONS

<u>Processor (386-25)</u>	<u>Coprocessor (387-25)</u>
U72	U73
<u>Weitek 3167 Coprocessor</u>	<u>Cache (82385-25)</u>
U57	U59

SYSTEM ROM INFORMATION

SYSTEM ROM LOCATIONS

U10 ODD
U2 EVEN

SYSTEM ROM REVISIONS (Spare Part No. 108283-001)

<u>Rev</u>	<u>PN on ODD ROM</u>	<u>PN on EVEN ROM</u>
K.2	109591-003	109592-003
M.1	109591-004	109592-004
N.1	109591-005	109592-005

POWER SUPPLY

Spare Part No. 108065-001

BATTERY

Spare Part No. 102929-001

1 MEGABYTE BASE MEMORY BOARD

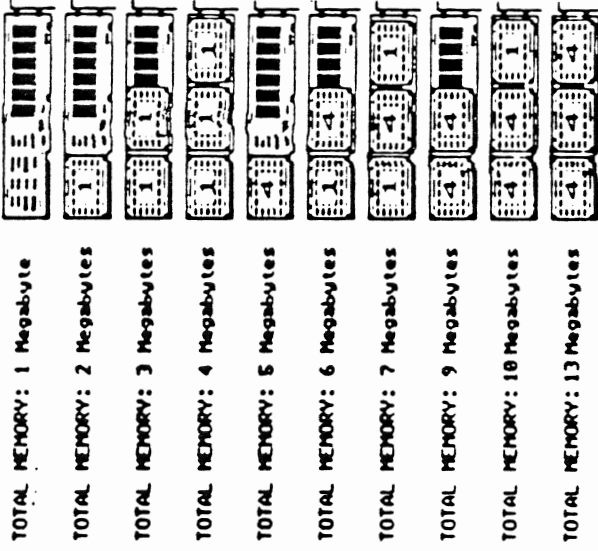

TOTAL MEMORY: 1 Megabyte

TOTAL MEMORY: 2 Megabytes

TOTAL MEMORY: 3 Megabytes

TOTAL MEMORY: 4 Megabytes

TOTAL MEMORY: 5 Megabytes

TOTAL MEMORY: 6 Megabytes

TOTAL MEMORY: 7 Megabytes

TOTAL MEMORY: 9 Megabytes

TOTAL MEMORY: 10 Megabytes

TOTAL MEMORY: 13 Megabytes



1 MEGABYTE MEMORY MODULE - 113131-001

4 MEGABYTE BASE MEMORY BOARD (113190-001)

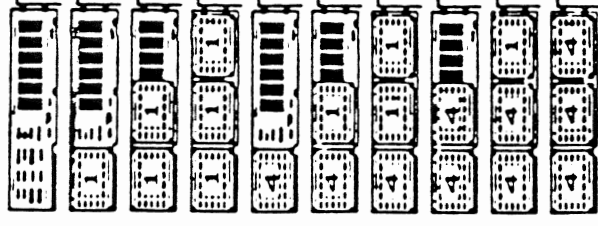

TOTAL MEMORY: 4 Megabytes

TOTAL MEMORY: 5 Megabytes

TOTAL MEMORY: 6 Megabytes

TOTAL MEMORY: 7 Megabyte

TOTAL MEMORY: 8 Megabytes

TOTAL MEMORY: 9 Megabytes

TOTAL MEMORY: 10 Megabytes

TOTAL MEMORY: 12 Megabytes

TOTAL MEMORY: 13 Megabytes

TOTAL MEMORY: 16 Megabytes



4 MEGABYTE MEMORY MODULE - 113132-001

COMPAQ DESKPRO 386/25 MEMORY UPGRADE CHART

DP386/25e

COMPAQ DESKPRO 386/25e

BOARD COMPATIBILITY LIST

<u>Product</u>	<u>Assy No.</u>	<u>Spare Part No.</u>	<u>Page</u>
SYSTEM BOARDS			
386/25e System	001427	122078-001	133
MEMORY BOARDS			
4MB Memory Module	000758/000993/ 001166-001/002	113226-001	X
1MB Memory Module	000762/000981/ 001076/001151-001 001256/001259	113225-001	X
1MB 32-Bit Memory	000960	112518-001	X
4MB 32-Bit Memory	000963	112517-001	X
CONTROLLER BOARDS			
Tape Adapter	000774	113259-001	A-3
ESDI External 300/600	001091	115839-001	A-3
15 MHz ESDI Cntrl	001628	121667-001	A-4
ESDI/Diskette Cntrl	001472	115374-001	A-4
VIDEO BOARDS			
Advanced Graphics 1024	109958	114201-001	A-8
Advanced Graphics Memory	109959	114202-001	X
VGA Pass-Through	001430	114241-001	X
MISCELLANEOUS			
Serial/Parallel Interface	000570	106886-001	A-8
Serial/Parallel Interface	000990	106886-001	A-9
2400-Baud Int Modem	001070	112693-001	X

DP386/25e

COMPAQ DESKPRO 386/25e

FIXED DISK DRIVES

Drive Size	Drive Type	Inter-leave	Inte-grated	Min ROM	Spare Part No.	Controller Assy No.
40 MB*	43	1:1	Y	P.6	112526-001	N/A
40 MB	22	1:1	Y	P.6	112526-001	N/A
60 MB	55	1:1	Y	P.6	122079-001	N/A
84 MB	27	1:1	Y	P.6	112438-001	N/A
110 MB*	33	1:1	Y	P.6	112525-001	N/A
120 MB	50	1:1	Y	P.6	122080-001	N/A
210 MB	51	1:1	Y	P.6	124013-001	N/A
300 MB ¹	38	1:1	N	P.6	113219-001	001628
320 MB	28	1:1	N	P.6	115182-001	001628

* See page A-13 for single and dual fixed disk drive switch settings and configuration.

¹ Used in Fixed Disk Expansion Unit. Requires MS-DOS 3.3 or later.

TAPE DRIVES

Drive Size	Spare Part No.	Tape Cartridge	Spare Part No.
40/60 MB	112524-001	40 MB (DC 2000)	108142-001
		60 MB	122086-001
80/120 MB	122087-001	80 MB	116966-001
		120 MB	116967-001
150/250 MB	115220-001	150 MB (DC 600 XTD)	113234-001
		250 MB	115298-001

DISKETTE DRIVES

Size	Spare Part No.
360 KB	112567-001
1.2 MB	112566-001
1.44 MB*	112565-001

* Requires MS-DOS Version 3.31 Revision A if installed as drive B, and MS-DOS Version 3.31 Revision B if installed as drive A.

DP386/25e

COMPAQ DESKPRO 386/25e

CABLE INFORMATION

Cable Function	Used With	Spare Part No.	
Diskette/Tape Signal	All Diskette Drives 40/60-MB Tape	113594-001	34 Pin
Mass Storage Power	All Diskette & Tape Drives	113596-001	
Mass Storage Power	40-, 60-, 84-, 110-, 120-, & 210-MB FDD Drive C	101741-001	6 In.
Mass Storage Power	40-, 60-, 84-, 110-, 120-, & 210-MB FDD Drive D	101741-004	15 In.
Mass Storage Power	320-MB FDD	115215-001	
Mass Storage Signal	320-MB FDD	100625-006 115197-001	20-Pin 34 Pin
Tape Signal	80-/120- & 150-/250-MB Tape Drives	113198-002	
FDD Signal	40-, 60-, 84-, 110-, 120-, & 210-MB FDD Drive C	113595-001	40 Pins
FDD Signal	40-, 60-, 84-, 110-, 120-, & 210-MB FDD Drive D	112528-001	40 Pins Y
External I/O	Expansion Unit	115810-001	
Telephone Cable	Modem	112666-001	
VGA Pass-Through	Adv Graphics	114229-001	

BOARD JUMPER/SWITCH SETTINGS

SYSTEM BOARD (001427)

Switch	Setting	Function
S1	ON*	Enable Integrated VGA
S1	OFF	Disable Integrated VGA
S2	ON*	Disable Power-On Password
S2	OFF	Enable Power-On Password

* Default

DP386/25e

COMPAQ DESKPRO 386/25e

PROCESSOR/COPROCESSOR LOCATIONS

<u>Processor (386-25)</u>	<u>Coprocessor (387-25)</u>
U139	U140
<u>Weitek 3167 Coprocessor (Spare Part No. 115517-001)</u>	
U140	

SYSTEM ROM INFORMATION

SYSTEM ROM LOCATIONS

U119 ODD
U141 EVEN

SYSTEM ROM REVISIONS (Spare Part No. 112694-001)

<u>Rev</u>	<u>PN on ODD ROM</u>	<u>PN on EVEN ROM</u>
P.6	122095-001	122096-001
R.2	122095-002	122096-002

POWER SUPPLY

Spare Part No. 112570-001

BATTERY/CLOCK MODULE

Spare Part No. 107872-001