



*Personal Computer
Hardware Reference
Library*

Guide to Operations

LIMITED WARRANTY

The International Business Machines Corporation warrants this IBM Personal Computer Product to be in good working order for a period of 90 days from the date of purchase from IBM or an authorized IBM Personal Computer dealer. Should this Product fail to be in good working order at any time during this 90-day warranty period, IBM will, at its option, repair or replace this Product at no additional charge except as set forth below. Repair parts and replacement Products will be furnished on an exchange basis and will be either reconditioned or new. All replaced parts and Products become the property of IBM. This limited warranty does not include service to repair damage to the Product resulting from accident, disaster, misuse, abuse, or non-IBM modification of the Product.

Limited Warranty service may be obtained by delivering the Product during the 90-day warranty period to an authorized IBM Personal Computer dealer or IBM Service Center and providing proof of purchase date. If this Product is delivered by mail, you agree to insure the Product or assume the risk of loss or damage in transit, to prepay shipping charges to the warranty service location and to use the original shipping container or equivalent. Contact an authorized IBM Personal Computer dealer or write to IBM Personal Computer, Sales and Service, P.O. Box 1328-W, Boca Raton, Florida 33432, for further information.

ALL EXPRESS AND IMPLIED WARRANTIES FOR THIS PRODUCT INCLUDING THE WARRANTIES OF MERCHANTABILITY AND FITNESS FOR A PARTICULAR PURPOSE, ARE LIMITED IN DURATION TO A PERIOD OF 90 DAYS FROM THE DATE OF PURCHASE, AND NO WARRANTIES, WHETHER EXPRESS OR IMPLIED, WILL APPLY AFTER THIS PERIOD. SOME STATES DO NOT ALLOW LIMITATIONS ON HOW LONG AN IMPLIED WARRANTY LASTS, SO THE ABOVE LIMITATIONS MAY NOT APPLY TO YOU.

IF THIS PRODUCT IS NOT IN GOOD WORKING ORDER AS WARRANTED ABOVE, YOUR SOLE REMEDY SHALL BE REPAIR OR REPLACEMENT AS PROVIDED ABOVE. IN NO EVENT WILL IBM BE LIABLE TO YOU FOR ANY DAMAGES, INCLUDING ANY LOST PROFITS, LOST SAVINGS OR OTHER INCIDENTAL OR CONSEQUENTIAL DAMAGES ARISING OUT OF THE USE OF OR INABILITY TO USE SUCH PRODUCT, EVEN IF IBM OR AN AUTHORIZED IBM PERSONAL COMPUTER DEALER HAS BEEN ADVISED OF THE POSSIBILITY OF SUCH DAMAGES, OR FOR ANY CLAIM BY ANY OTHER PARTY.

SOME STATES DO NOT ALLOW THE EXCLUSION OR LIMITATION OF INCIDENTAL OR CONSEQUENTIAL DAMAGES FOR CONSUMER PRODUCTS, SO THE ABOVE LIMITATIONS OR EXCLUSIONS MAY NOT APPLY TO YOU.

THIS WARRANTY GIVES YOU SPECIFIC LEGAL RIGHTS, AND YOU MAY ALSO HAVE OTHER RIGHTS WHICH MAY VARY FROM STATE TO STATE.



*Personal Computer
Hardware Reference
Library*

Guide to Operations

FEDERAL COMMUNICATIONS COMMISSION

RADIO FREQUENCY INTERFERENCE STATEMENT

WARNING: This equipment has been certified to comply with the limits for a Class B computing device, pursuant to Subpart J of Part 15 of FCC rules. Only peripherals (computer input/output devices, terminals, printers, etc.) certified to comply with the Class B limits may be attached to this computer. Operation with non-certified peripherals is likely to result in interference to radio and TV reception.

First Edition (August 1981)

Changes are periodically made to the information herein; these changes will be incorporated in new editions of this publication.

Products are not stocked at the address below. Requests for copies of this product and for technical information about the system should be made to your authorized IBM Personal Computer Dealer.

A Product Comment Form is provided at the back of this publication. If this form has been removed, address comment to: IBM Corp., Personal Computer, P.O. Box 1328, Boca Raton, Florida 33432. IBM may use or distribute any of the information you supply in any way it believes appropriate without incurring any obligations whatever.

Preface

This publication provides you with an introduction to the IBM Personal Computer. Included are instructions for Setup, Problem Determination Procedures (PDPs) Option Installation and Relocate.

Once your system is functional, Operation Instructions will aid you in the use of your new system.

This publication is intended for anyone who will be setting up, using or programming the IBM Personal Computer.

This guide has six sections:

Section 1. Introduction, will highlight the configurations available and identify the wide variety of options available to you.

Section 2. Setup Procedures, contains instructions for placement, cabling, and running the System Mini-test of your new IBM Personal Computer.

Section 3. Operation Instructions, introduces the user to the fundamentals of system use.

Section 4. Problem Determination Procedures (PDPs), is the section that will assist you in correcting problems that may occur during setup and/or normal operations.

Section 5. Options, instructs you on how to install, check out and solve any problems that may occur during the installation of any of the options available.

Section 6. Relocate, provides the information needed if it becomes necessary to uncable and relocate your system.

The Easy Way to Start

Let's take a look at the easiest way to use *Guide to Operations*. The first thing you should notice is the six external tabs labeled: *INTRO*, *SETUP*, *OPERATIONS*, *PDPs*, *OPTIONS*, and *RELOCATE*. These are the major sections and the tabs will help you get to the information you need quickly.

INTRO: This section will highlight the way your IBM Personal Computer can be arranged and show you some of the many options available to you in both hardware and software.

SETUP: This part of the Guide helps you cable and test your system to see that it's working Okay.

OPERATIONS: Let's call this the learning and reference section. Behind the section tab you will find a content page, and on the right side of the page you will notice what we call bleeder tabs. The bleeder tabs help you select what information you want within a section. The bleeder tabs that have lots of pages also have their own detailed content pages (for example, Printer, DOS). If you're new to computers, this section is written in easy-to-understand language, and we think you'll find it helpful to spend a little time reading it and trying out a few of the examples on your IBM Personal Computer. If you are experienced at using computers, this section may be used for a handy reference.

PDPs: Problem Determination Procedures. If you have any type of problem with your IBM Personal Computer, this is the section you will go to. To help you solve your problems most effectively, *all* notes, steps, and information should be read carefully. This section can also be used to thoroughly check out your system.

OPTIONS: This is the do-it-yourself section. The installation instructions you receive when you purchase an option should be inserted behind the proper bleeder tab. This part of *Guide to Operations* can contain a few pages or many pages depending on how many options you have.

RELOCATE: Whenever you need to move your IBM Personal Computer, this section should be reviewed. It contains a few hints on how to move your system safely and without damage.

GUIDE TO OPERATIONS

Contents

Section 1. Introduction	Intro 1-1
Section 2. Setup	Setup 2-1
Section 3. Operations	Operations 3-1
Getting Your IBM Personal Computer Ready	Getting Ready 3-1
Keyboard Layout and Usage	Keyboard 3-1
IBM 80 CPS Matrix Printer Operations	Printer 3-1
Using DOS	DOS 3-1
Using BASIC	BASIC 3-1
Section 4. Problem Determination Procedures (PDPs)	PDPs 4-1
Section 5. Options	Options 5-1
Cabling Your IBM Monochrome Display	Display 5-1
IBM Monochrome Display and Parallel Printer Adapter Option Installation	Display 5-3
Color/Graphics Monitor Adapter Option Installation	Display 5-21
IBM 80 CPS Matrix Printer Option Installation	Printer 5-1
Parallel Printer Adapter Option Installation	Printer 5-15
5¼" Diskette Drive	Diskette 5-1
5¼" Diskette Drive Adapter	Diskette 5-33
16KB Memory Module Kit Option Installation	Memory 5-1
32KB Memory Expansion Option Installation	Memory 5-21
64KB Memory Expansion Option Installation	Memory 5-41
Game Control Adapter	General 5-1
Asynchronous Communications Adapter	General 5-15
Section 6. Relocate	Relocate 6-1

Notes:



SECTION 1. INTRODUCTION

Contents

Introduction	Introduction 1-3
Configuration Examples	Introduction 1-4
Option Examples	Introduction 1-6

Notes:



Introduction

Welcome to the world of the IBM Personal Computer. Your new system offers a wide variety of options to give you the ability to custom-tailor your system to meet your needs now, and the growth potential for the future.

The heart or brains of your Personal Computer is the System Unit. Under the covers of this powerful table-top unit is where the options are installed in any of the five expansion slots along with housing two internal 5¼" Diskette Drives. The choice of options is what allows this computer to meet your needs. Your System Unit will support a variety of black and white or color televisions and monitors for home entertainment, education, and business applications.

Your input to the System Unit is through an 83-key keyboard which includes a numeric keypad and 10 function keys. The keyboard is connected to the System Unit with a six-foot coiled cable which allows you to move the keyboard to a comfortable operating position.

The IBM 80 CPS Matrix Printer is a highly versatile Printer featuring 80 characters per second, bi-directional printing. Characters can be printed in any desired size; enlarged, condensed, emphasized, and normal. The use of ASCII codes lets you print all characters, symbols and graphics on single or multi-part forms ranging in widths from 4" to 10". The Printer receives its instructions from the System Unit through a Parallel Printer Adapter and signal cable.

A special set of instructional material comes with your Personal Computer so you don't have to be a computer expert to be able to operate this powerful but compact system.

You will find a few examples on the following pages that show some of the basic configurations and options that your new system can have. Take a few minutes to familiarize yourself with the many functions and applications you will be capable of performing.

The non-IBM devices in this manual are for illustration only, and their use here does not constitute a recommendation or an endorsement by IBM. Selection, interconnection, and use of another manufacturer's device, are the sole responsibility of the customer.

Configuration Examples

IBM Monochrome Display

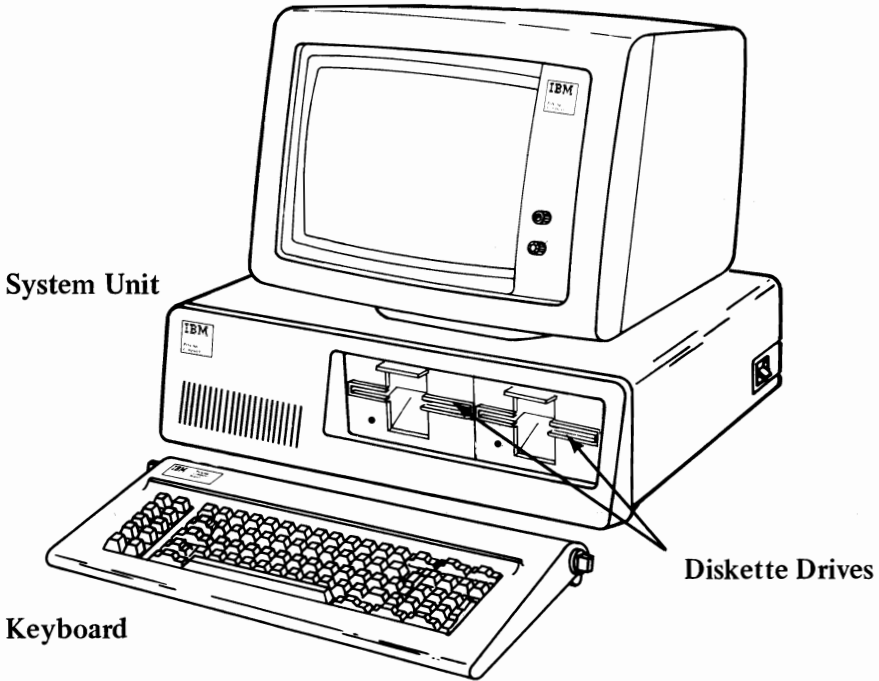

System Unit

Diskette Drives

Keyboard

IBM 80 CPS Matrix Printer

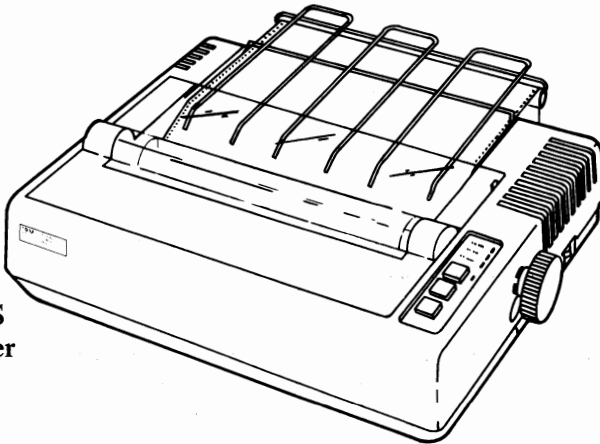

This example shows the System Unit, Keyboard, and an IBM Monochrome Display. Two 5 1/4" Diskette Drive Units are used as your program media. Hard-copy output is provided with an IBM 80 CPS Matrix Printer.

**Monitor or Television
Supplied by User**

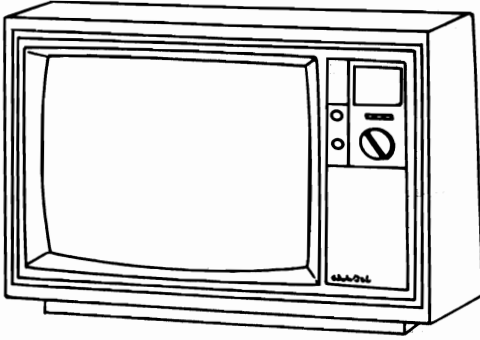

System Unit

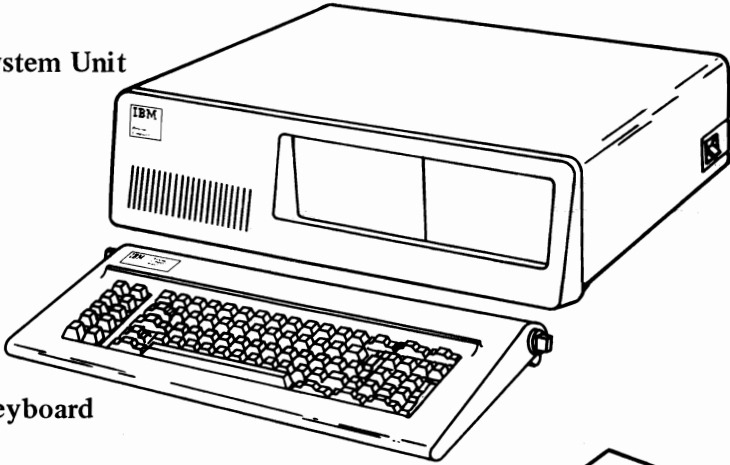

Keyboard

**Cassette Recorder
Supplied by User**

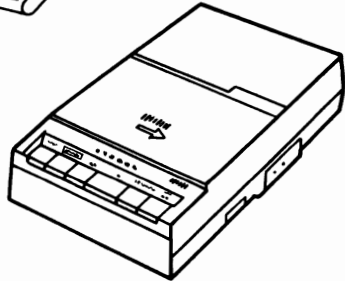

This example shows the System Unit, Keyboard, and your choice of monitors or televisions. You can use your cassette recorder as the program media.

Option Examples

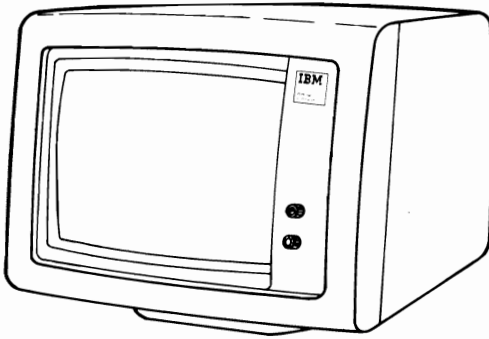

IBM Monochrome Display

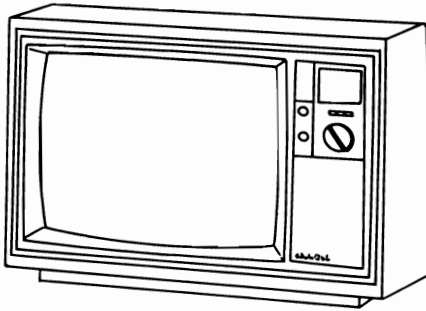

Color or Black and White Television

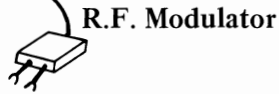

R.F. Modulator

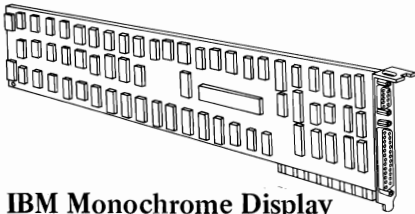

IBM Monochrome Display and Parallel Printer Adapter

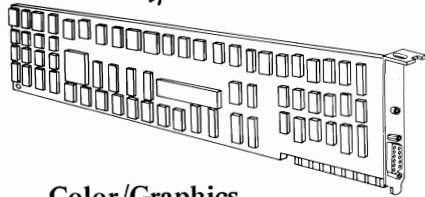

Color/Graphics Monitor Adapter

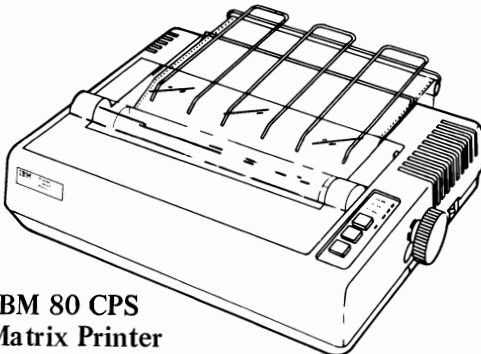

IBM 80 CPS Matrix Printer

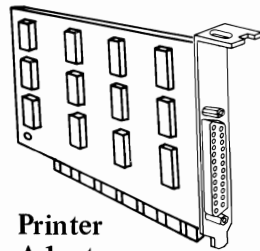

Printer Adapter

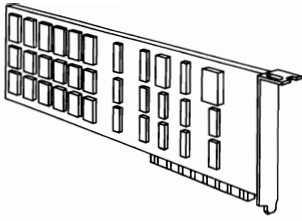

Up to 256 KB of Memory

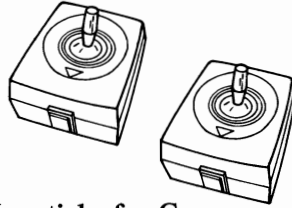

Joysticks for Games

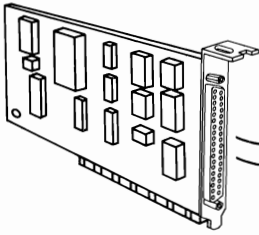

Asynchronous Communications Adapter

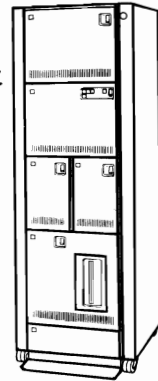
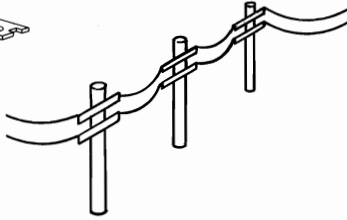

Big Computer

DISKETTE

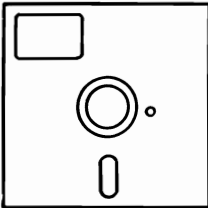

Adventure

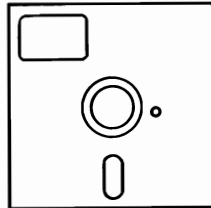

Accounting

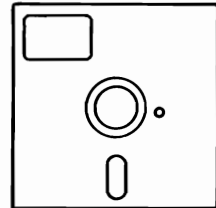

Inventory

CASSETTE

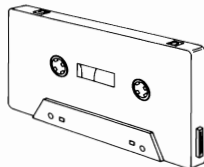

Typing Tutorial

Notes:



SECTION 2. SETUP

Contents

Cabling Your IBM Personal Computer	2-3
Mini Power-on Self-test	2-6
Rear Panel Reference	2-7
Component Arrangement	2-8
Keyboard and Monitor Adjustment	2-9
Power-on Self-test	2-11
Loading Diagnostic Aids	2-16
Diskette	2-16
Cassette	2-17
Running Mini-test	2-19
Summary	2-21

Notes:



Cabling Your IBM Personal Computer

1. If your Personal Computer came with a Diskette Drive installed.

SYSTEM UNIT

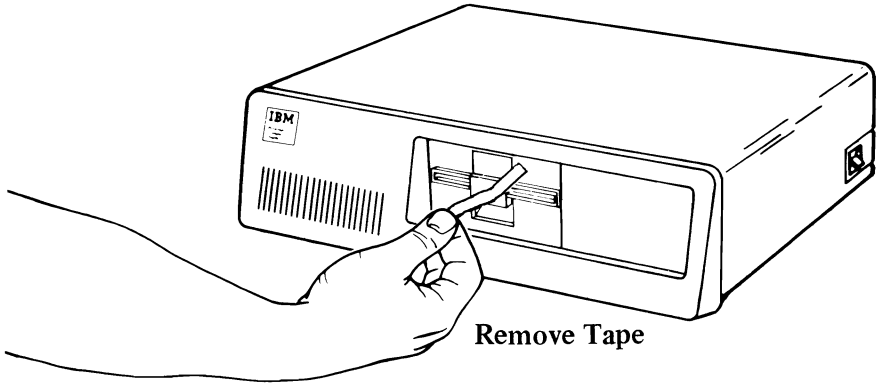

SYSTEM UNIT

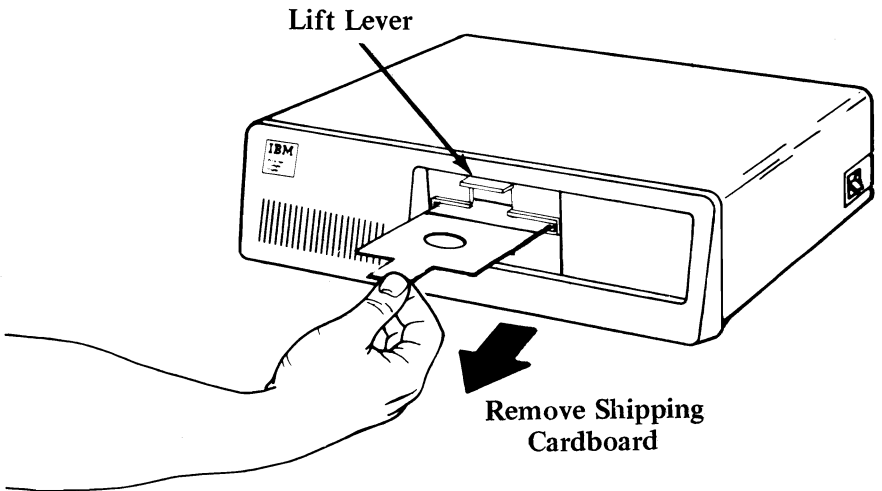

2. Place System Unit on work area in position shown.

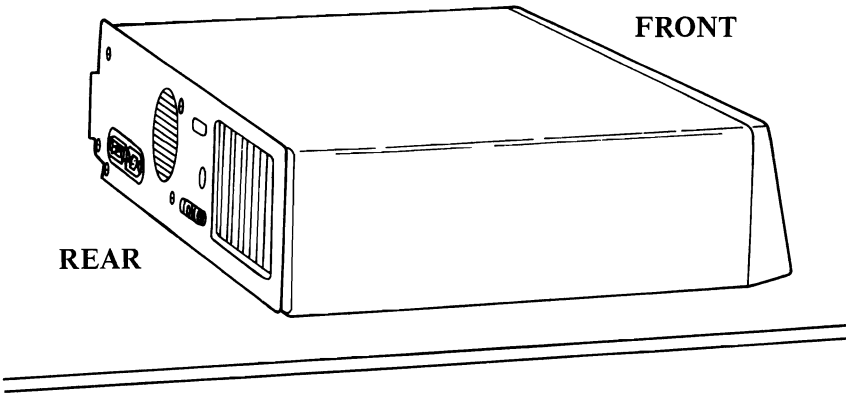

3. Place Keyboard next to System Unit and connect cable as shown.

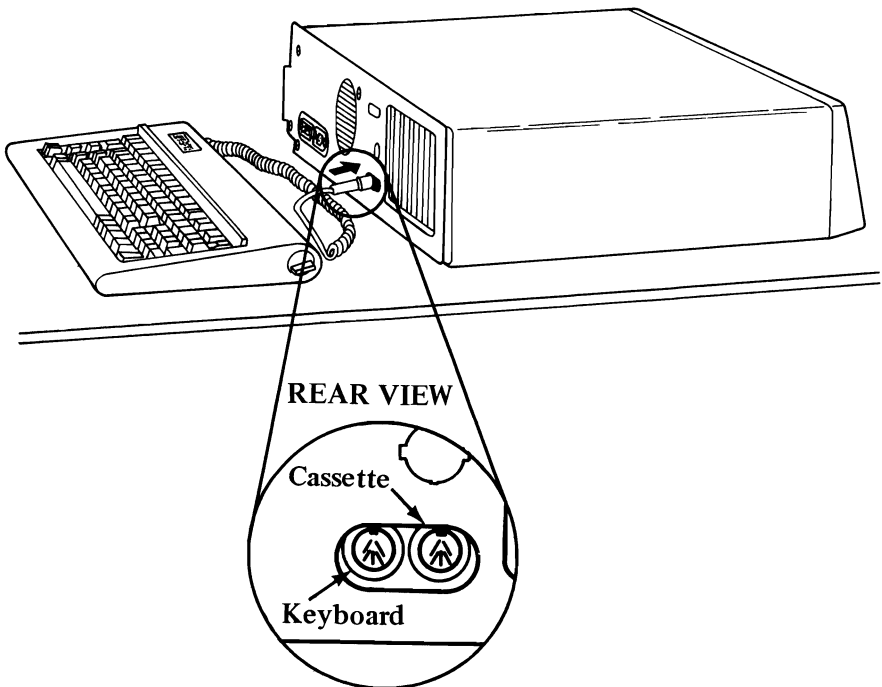

4. Position System Unit switch to OFF.

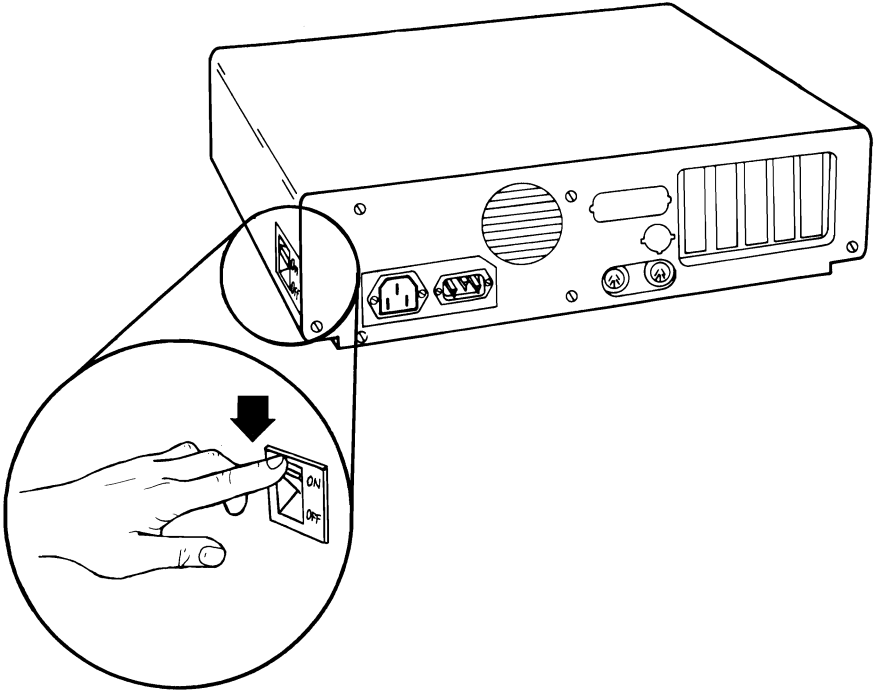

5. Connect System power cord to System Unit first, then to wall outlet.

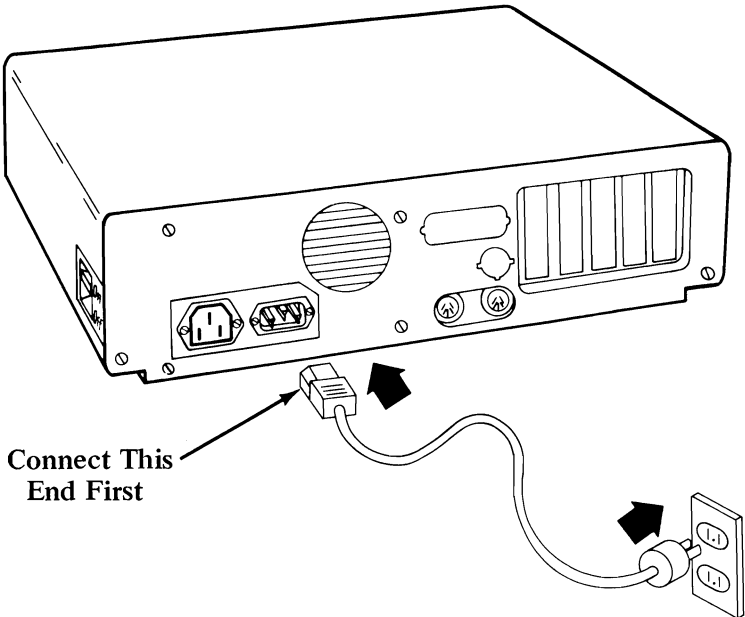

Mini Power-on Self-test

6. Position System Unit switch to ON. There should be one short beep.

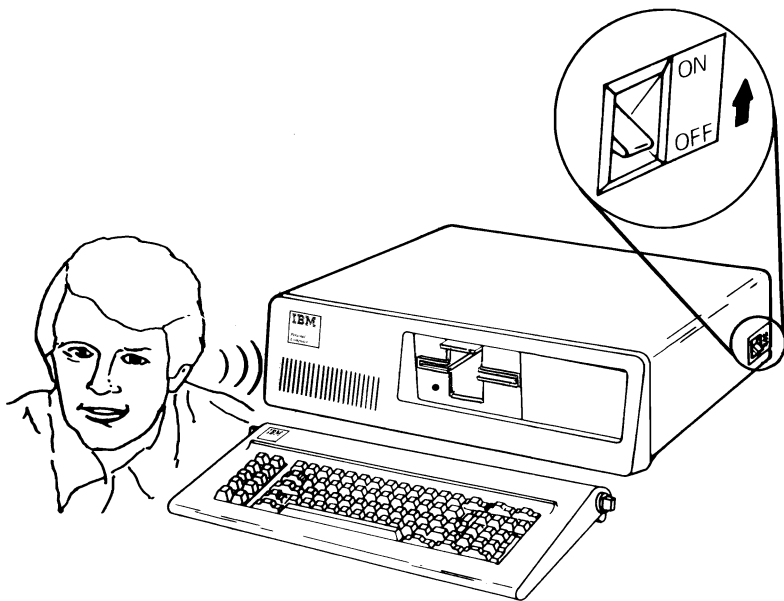

If you heard one short beep, your System Unit has completed its Self-test.

If you heard other than one short beep, return your IBM Personal Computer to place of purchase.

If you have any options you would like to install now, go to Section 5, "Option Installation." When complete, return to this section and continue.

You may save time if you follow the sequence listed below, when installing your options:

1. 16KB Memory Expansion Kit.
2. Diskette Drive(s).
3. All other Option Adapter(s).

Rear Panel Reference

Welcome back from Option Installation. Use the handy reference diagram below and connect all your cables and cords. When done, continue with next page.

REAR PANEL

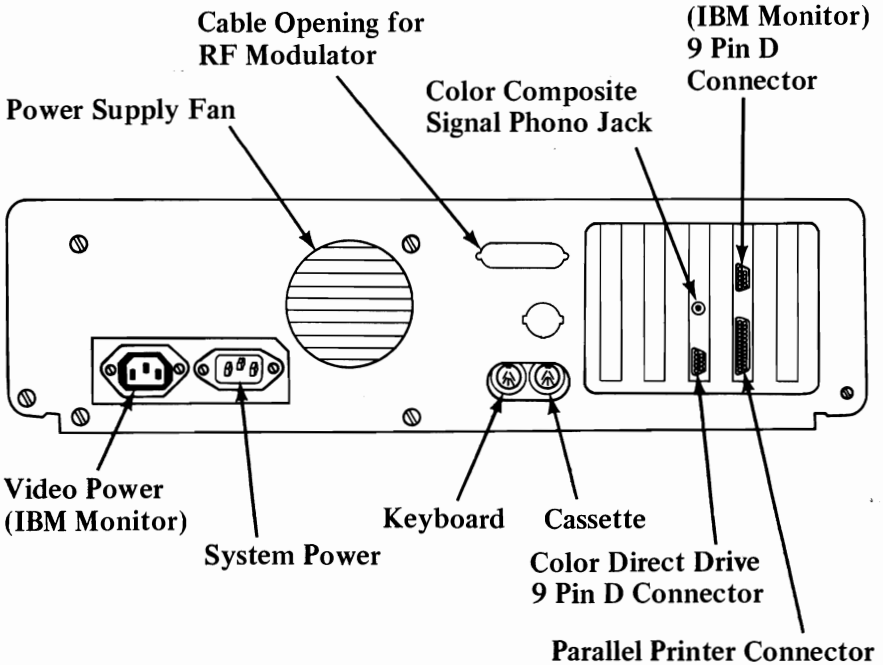

Before going to Step 7, read the note below.

Note: If you are using a home television or various monitors as your display you could experience data errors while using your Diskette Drive. This interference is easily cured by moving your television 12" away from your IBM Personal Computer.

Component Arrangement

7. When cabling of your IBM Personal Computer is complete, move your system components to the desired operating position. Two of the more common configurations are shown below.

IBM MONOCHROME DISPLAY

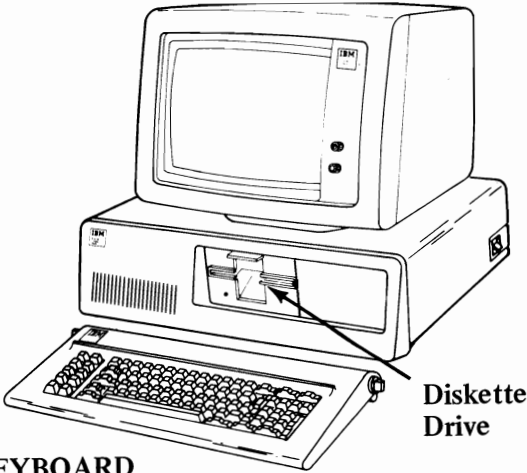

Diskette Drive

KEYBOARD

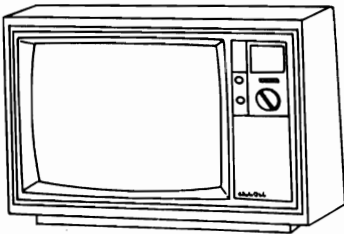

MONITOR or TELEVISION
Supplied by User

SYSTEM UNIT

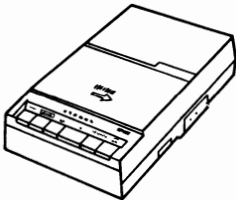

CASSETTE
RECORDER
Supplied by User

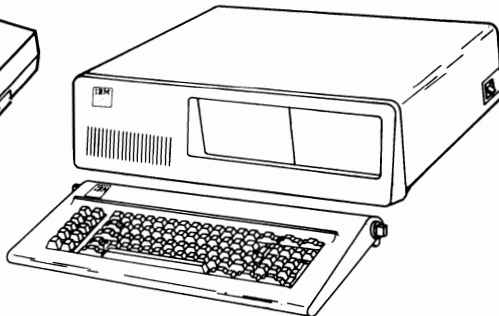

Keyboard and Monitor Adjustment

8. The Keyboard has two positions for typing comfort.

CAUTION: Hold Keyboard when changing positions.

There is one adjustable leg located at each end of keyboard.

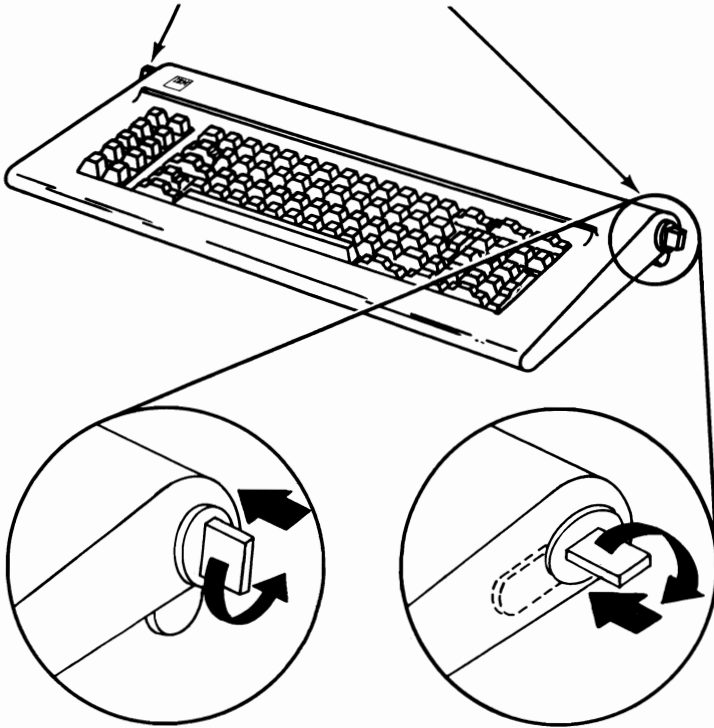

TILT POSITION
Push in firmly and turn.

LEVEL POSITION
Push in firmly and turn.

Adjust at this time.

9. Your new IBM Personal Computer is ready for a System Mini-test.
10. Turn monitor or TV contrast and brightness controls fully clockwise.

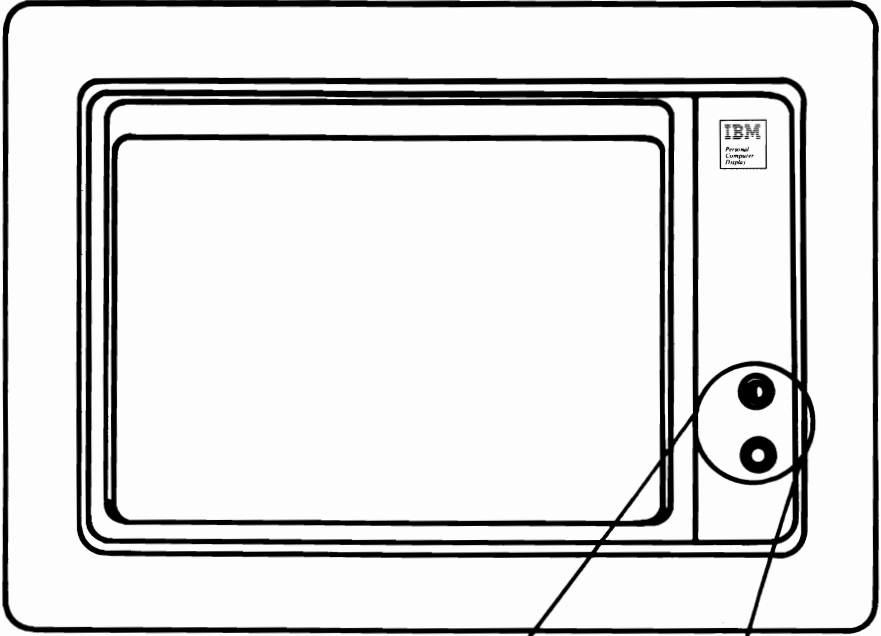

**IBM MONOCHROME
DISPLAY**

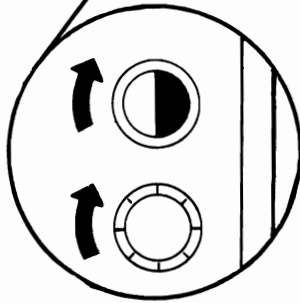

Go to Step 11.

Power-on Self-test

- 11.** When you first position System Unit switch to on, it performs a Power-on Self-test. The time the Self-test takes is determined by the amount of memory your system has (3 to 45 seconds).

Position the System Unit switch to ON. There will normally be three responses:

1. Cursor will appear on screen in approximately 4 seconds.
2. One short beep will be heard after memory is tested.
3. "IBM Personal Computer" will appear on screen.

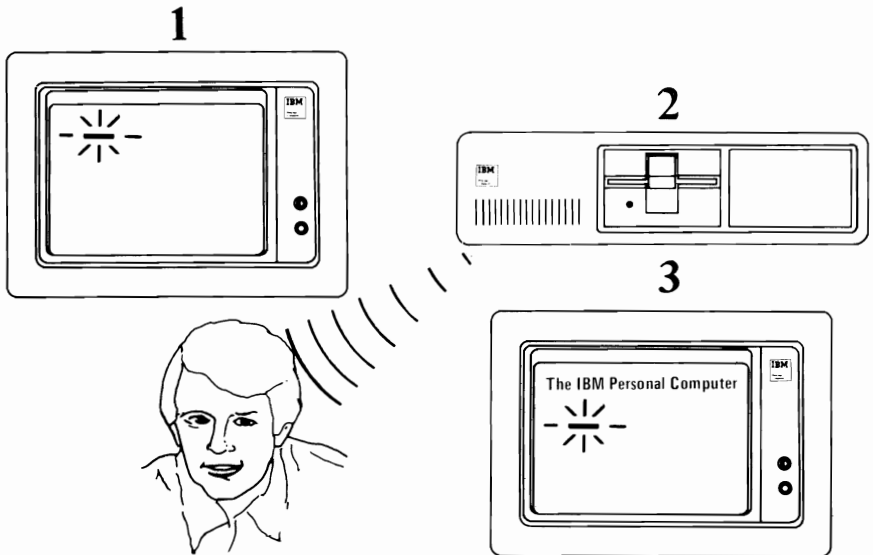

Note: These three responses tell you that your Self-test has completed successfully. Other information will appear on screen and is not important at this time.

If responses were incorrect, go to Section 4, "Problem Determination Procedures" (PDPs).

If responses were correct, go to Step 12.

- 12.** If you are using a home television or various monitors with your IBM Personal Computer and the screen looks similar to the examples on the following pages refer to the solution under each example.

EXAMPLE 1 When Using Diagnostic Aids Diskette or Cassette

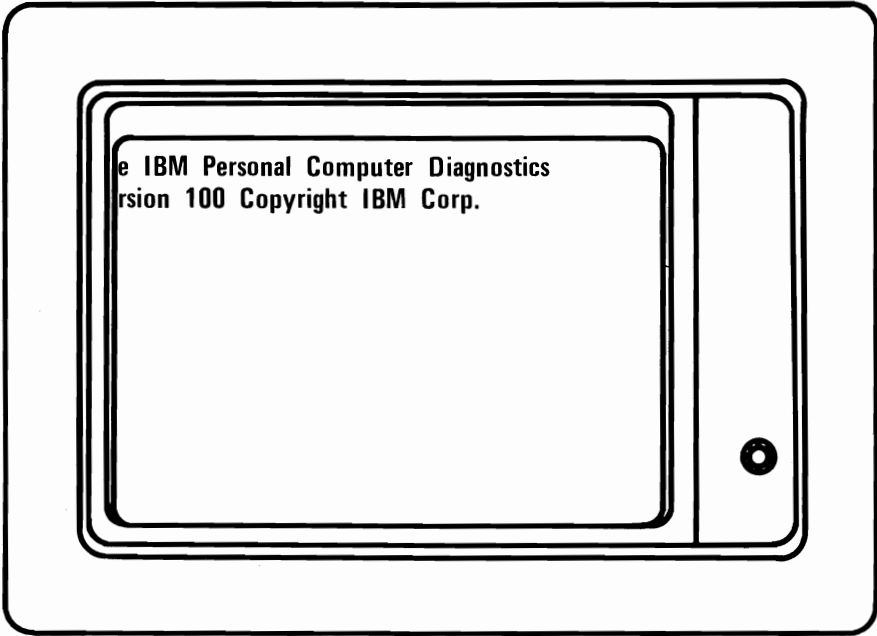

Solution: Press Function key  to move screen to the right.

Press Function key  to move screen to the left.

Step 12 continues on next page.

EXAMPLE 2 When Using Cassette System

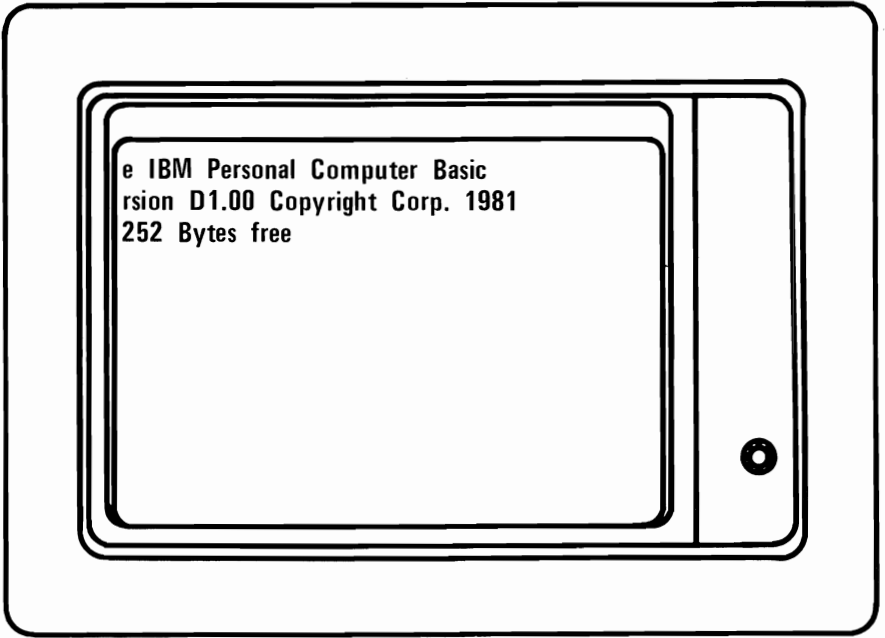

Solution: Refer to “OUT” command in Section 3. “Using BASIC.”

Step 12 continues on next page.

EXAMPLE 3 When Using Diskette System

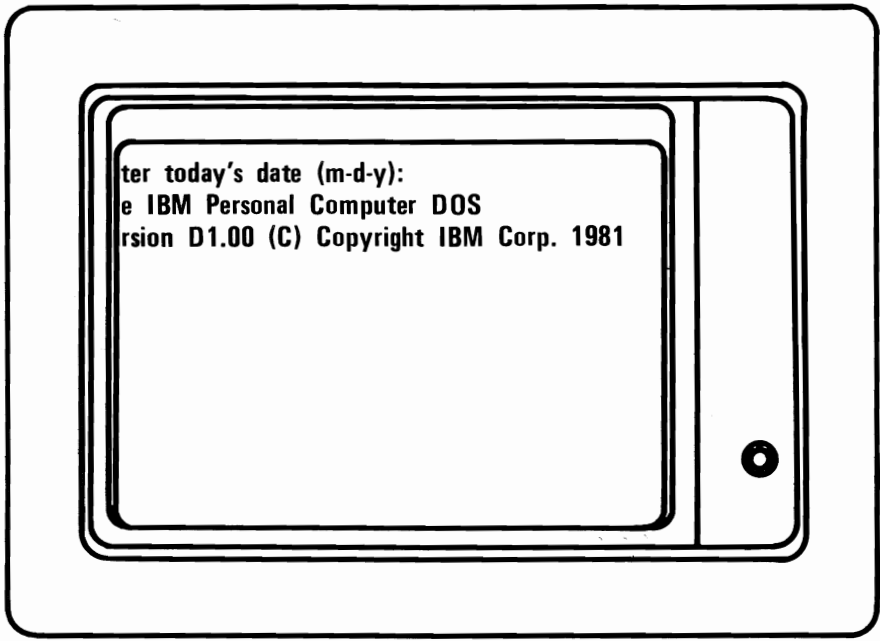

Solution: Refer to “MODE” command in Section 3. “Using DOS.”

Go to Step 13.

13. Adjust contrast and brightness controls for eye comfort.

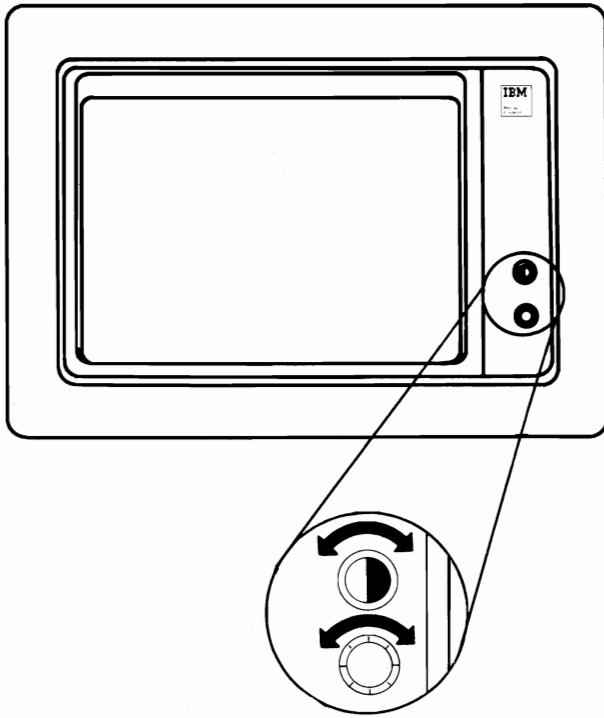

Note: The system Mini-test will be run using diskettes (cassette test will be similar).

14. Select the diskette that is labeled Diagnostic Aids.

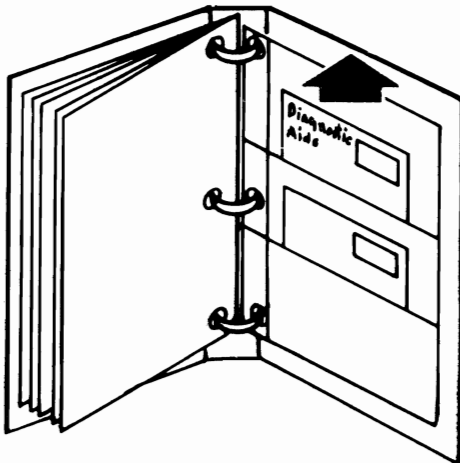

Go to Step 15.

Loading Diagnostic Aids

Diskette

15. How to load Diagnostic Aids diskette.

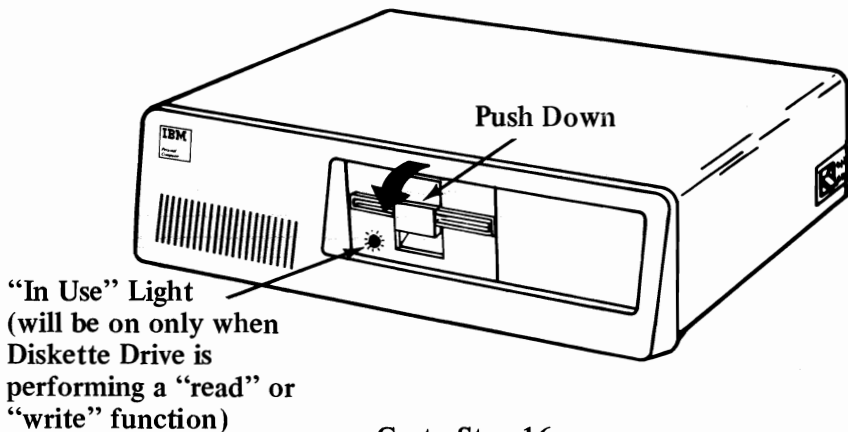
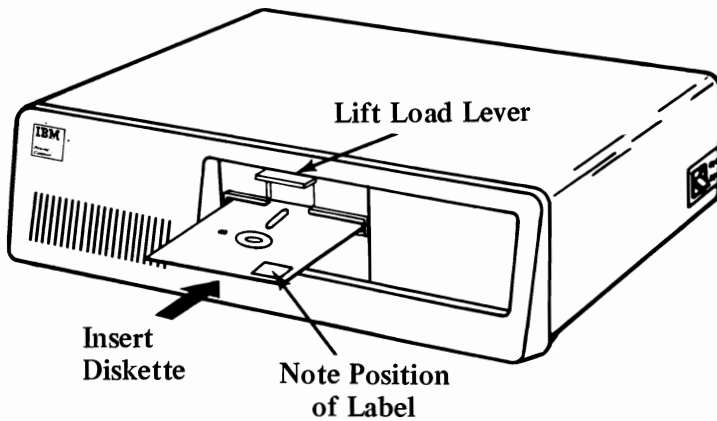

- Position System Unit switch to OFF.
- Lift load lever.
- Insert diskette until rear stop is felt.
- Push down load lever.
- Position System Unit switch to ON.



Go to Step 16.

Cassette

16. If you are using a cassette recorder to test your system, follow the procedures below:

- Familiarize yourself with your Cassette Users Manual before continuing.
- Insert Diagnostic Aids cassette.
- Rewind to the beginning.
- Position System Unit switch to ON. (Wait for Self-test to complete.)
- Turn volume on cassette to high.
- Press play on cassette recorder.
- Type **load"ldcass** on keyboard.
- Press  enter.
- Look to verify that your cassette is turning.
- Wait for **.B found** to appear on screen, then wait for **Ok** to appear on screen.
- Type **RUN** on keyboard.
- Press  enter.
- Wait for option frame, approximately a minute or two.
- Look to verify that your cassette is turning.
- When cassette is loaded the screen will be similar to the figure below.



Step 16 continues on next page.

If you could not load your cassette, the most likely causes are:

1. Cassette recorder
2. Wrong or damaged cassette
3. Keyboard failure.

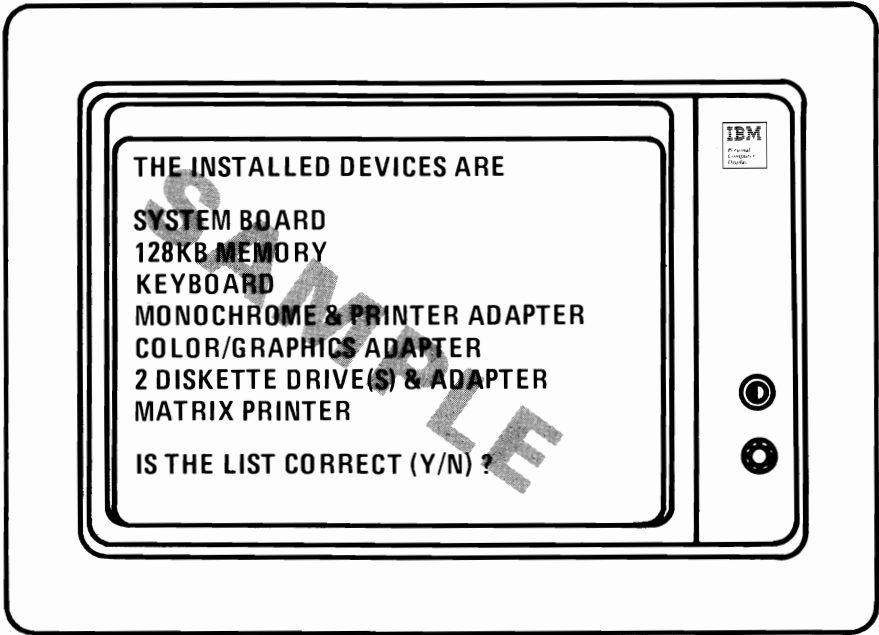
Contact your place of purchase if you cannot continue.



Press  then  enter.

Go to Step 17.

Running Mini-test

17. With cassette, your screen response will match the figure below.

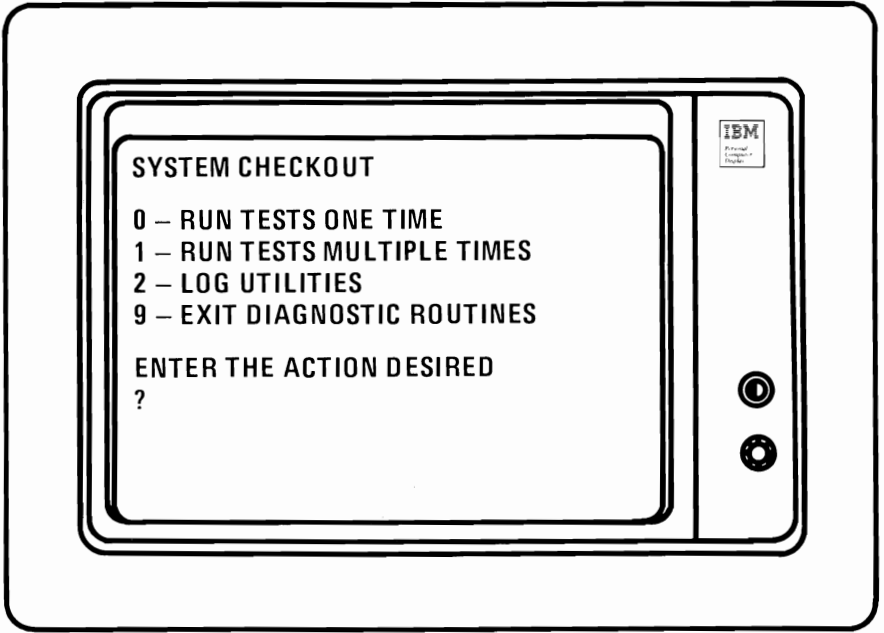

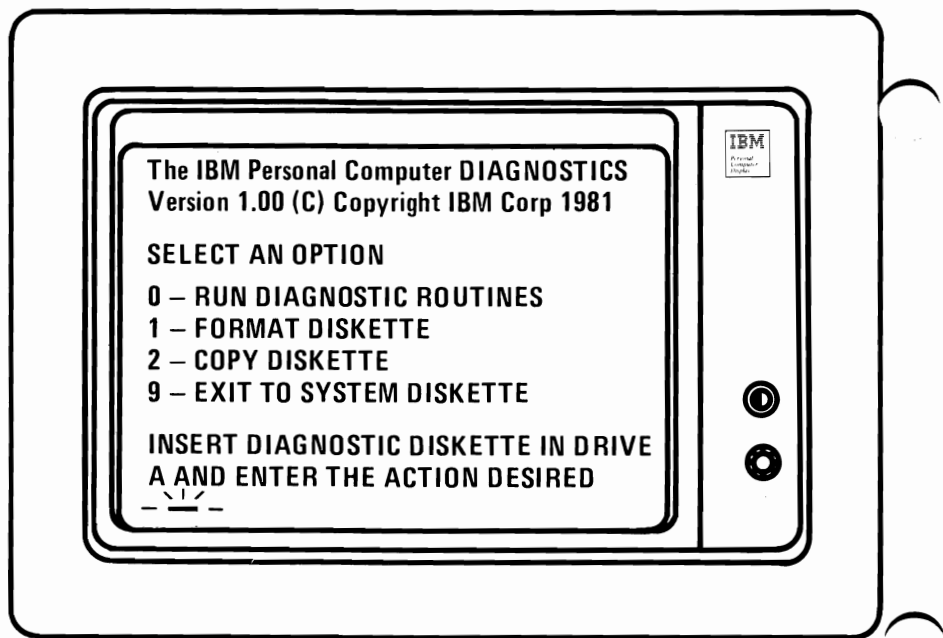

Go to Step 18.

18. With diskette, your screen will match the figure below.



If the screen does not match either of the figures above, go to Section 4, "Problem Determination Procedures" (PDPs).

19. Press  then  enter.

Go to Summary on the following page.

Summary

This completes your system Mini-test.

IBM recommends you perform a complete system checkout whenever you recable your machine or install an option. The system checkout is titled Section 4. "Problem Determination Procedures."

Return your Diagnostic Aid cassette or diskette to **Guide to Operations**.

You are now ready to learn the fundamentals of your system (Section 3. "Operation Instructions") or to return to your software program.

Notes:



SECTION 3. OPERATIONS

Contents

Getting Your IBM Personal Computer Ready

Keyboard Layout and Usage

IBM 80 CPS Matrix Printer

Using DOS

Using BASIC

GETTING READY

KEYBOARD

PRINTER

DOS

BASIC

Notes:

Introduction

Within this section are instructions enabling you to start using your IBM Personal Computer. This section contains an explanation of the Power-on Self-test that identifies your IBM Personal Computer is ready for use. This section also provides a graphic layout of the keyboard and each key function.

If your IBM Personal Computer has an 80 CPS Matrix Printer or a 5¼" Diskette Drive, this section will be a handy reference when getting started and a quick reminder in the future.

As you become more proficient in using your new IBM 80 CPS Matrix Printer, you will find the ASCII code chart a valuable tool for accessing the many control, graphic and special character set codes.

If you purchased the IBM Personal Computer Disk Operating System (DOS), the pages in this section teach you how to use many of the DOS commands. For example, you will learn how to format and make backup copies of diskettes. This part of Section 3 will also guide you through running the SAMPLES program which is supplied on the DOS diskette. Instructions are also provided here for running Disk BASIC and Advanced BASIC programs.

Notes:



Getting your IBM Personal Computer Ready

1. Turn Monitor or Television contrast and brightness controls fully clockwise (CW).

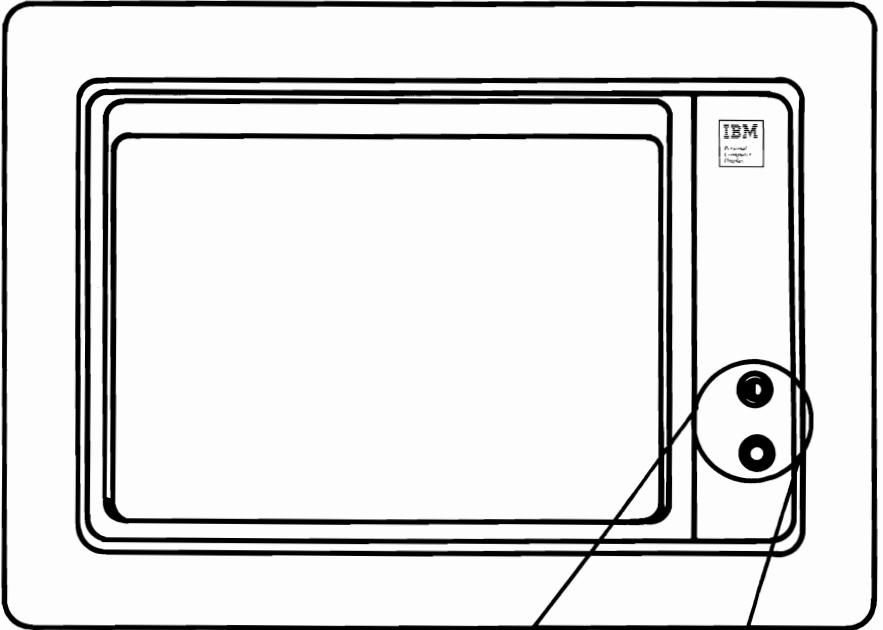

IBM MONOCHROME DISPLAY

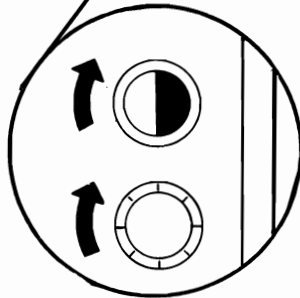

2. When you first position System Unit switch to ON, it performs a Power-on Self-test. The time the Self-test takes is determined by the amount of memory your system has (3 to 45 seconds).

Position the System Unit switch to ON. There will normally be three responses:

- A. Cursor will appear on screen in approximately 4 seconds.
- B. One short beep will be heard after memory is tested.
- C. IBM Personal Computer will appear on screen.

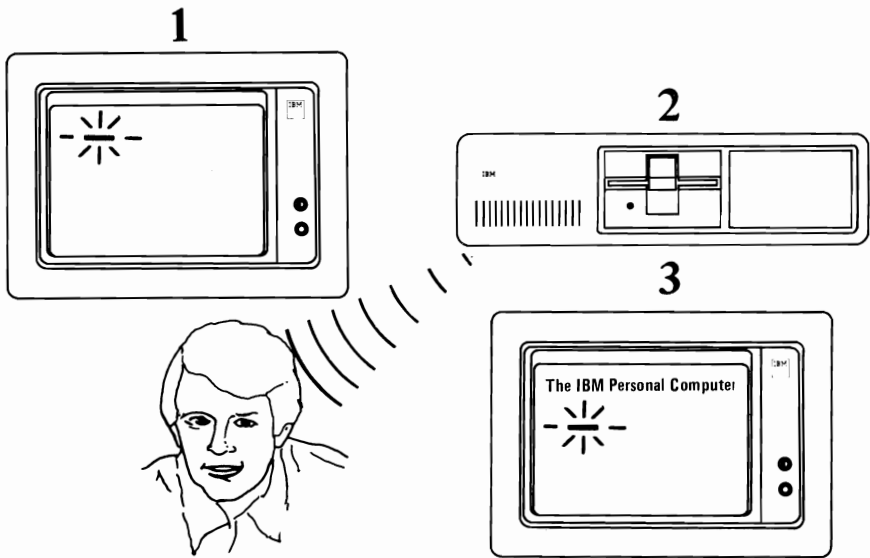

Note: These three responses verify that your Self-test has completed successfully. Other information will appear on screen and is not important at this time.

If any of the responses were incorrect:

- A. Position switch to OFF, unplug power cord and check all cable and power cord connections.
- B. Check wall outlet for power (use a desk lamp).
- C. Plug power cord in wall outlet and position System Unit switch to ON.

If responses are still incorrect, go to Section 4, “Problem Determination Procedures” (PDPs).

3. Adjust contrast and brightness controls for eye comfort.

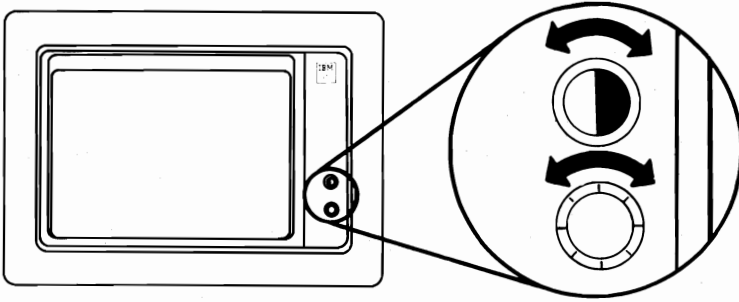

4. The screen should look similar to this figure. If this screen *does not* look similar, refer to Section 4, "Problem Determination Procedures" (PDPs).

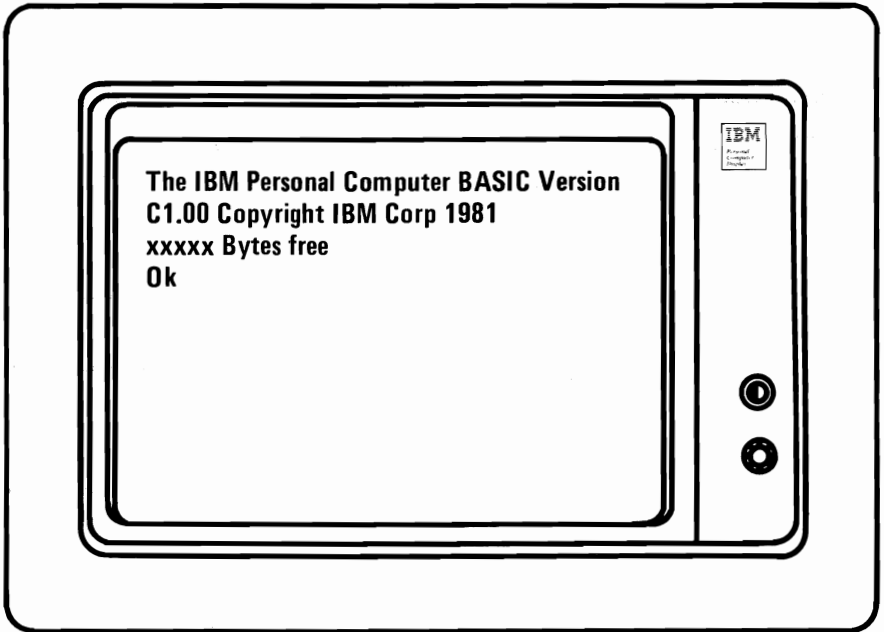

Notes:



BASIC Keyboard Usage

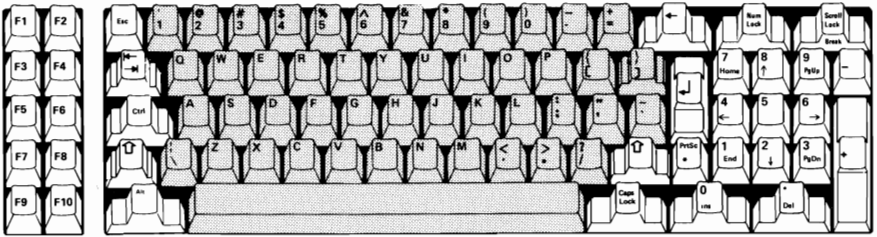

These keys are used the same as a typewriter.



These keys are used to aid you in writing, updating and running your programs:

Key	Description
ESC	“ESCAPE” removes the list line that the cursor is on for corrections, but the line is not deleted from memory.
← →	“TAB” performs a tab function similar to a typewriter. Tabs are set every 8 characters.
CTRL	“CONTROL” key is always used with another key to perform a command or function.
⇧	“SHIFT” changes lower case letters to capitals.
ALT	“ALTERNATE” is used with alpha typing keys to enter BASIC key words.
←	“BACKSPACE” key moves cursor to the left and removes one character for each key stroke.
↵	“ENTER” moves the cursor from the last character on one line to the first character of the next line. Shows logical end of line.

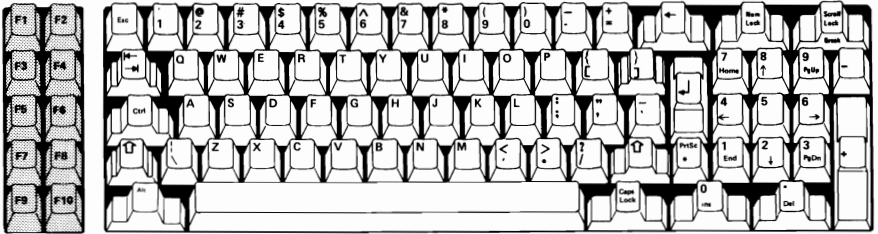

These are program function keys. They are used to make the system perform the commands listed below:

Key	Description
F1	“LIST” displays the lines of your program on the screen.
F2	“RUN” causes your program to begin execution from the beginning of the program.
F3	“LOAD” reads your program from auxiliary storage (e.g., cassette) and stores it in main memory.
F4	“SAVE” stores your program on auxiliary storage (e.g., cassette).
F5	“CONT” restarts your program after you have interrupted it by a STOP or CTRL BREAK.
F6	“LPT1:” refers to line printer and transfers data from screen to printer.
F7	“TRON” means trace on and causes the line numbers of program lines to be displayed as the lines are executed.
F8	“TROFF” means trace off and cancels command F7.
F9	“KEY” is used to change the function of other function keys.
F10	“SCREEN” returns program to character mode from graphics mode and turns off color.

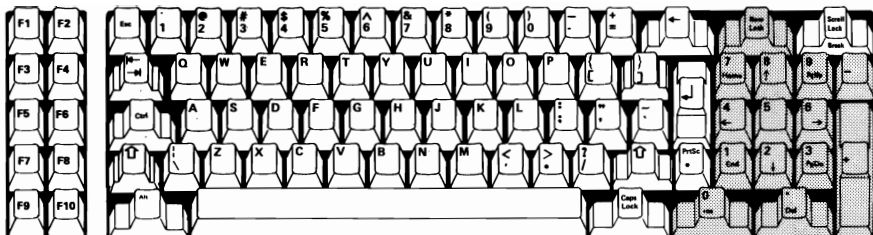

The “NUM LOCK” means number lock and is a toggle key; press once and the numeric key pad is activated. Press again and the numeric pad is cancelled.

Key	Description
1 thru 9	With “NUM LOCK” activated ONE through NINE will be operative.
. DEL	“DECIMAL POINT” is used with numeric key pad.
0 INS	“ZERO” is used with numeric key pad.
-	“MINUS” is used with the numeric key pad.
+	“PLUS” is used with the numeric key pad.

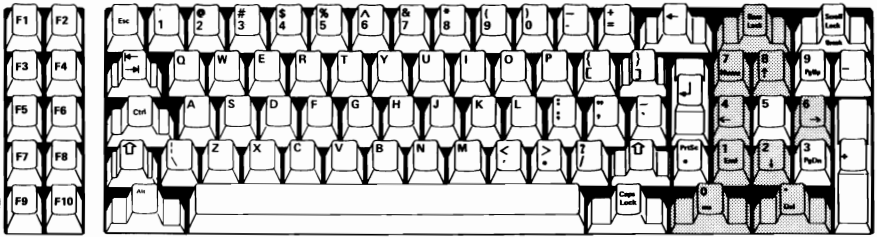

When the “NUM LOCK” is pressed to cancel the numeric key pad, the following keys will be operative:

Key	Description
7 HOME	“HOME” moves the cursor the first character of the top line of the screen.
8 ↑	Moves the cursor one line up for each key stroke.
4 ←	Moves the cursor to the left one character for each key stroke.
6 →	Moves the cursor to the right one character for each key stroke.
2 ↓	Moves the cursor down one line for each key stroke.
1 END	“END” moves the cursor to the last character on that line.
. DEL	“DELETES” the character where the cursor is positioned.
0 INS	“INSERT” sets the keyboard to insert mode so that keys will be entered at the position of the cursor and all data to the right will move to the right. Press “INSERT” key again to exit insert mode.

KEYBOARD

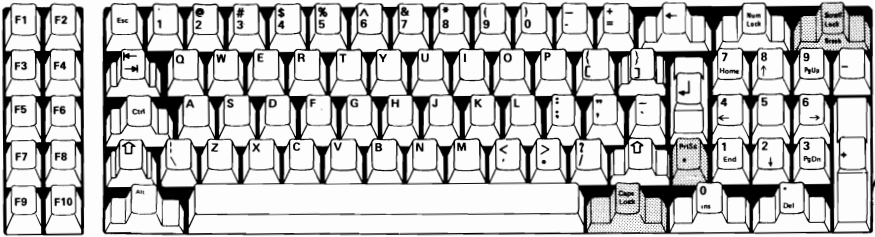

These keys will perform the following functions:

Key	Description
CAPS LOCK	This is a toggle key: pressing the key will cause letters to type in upper case (capitals). Pressing the key again will return lower case.
PRT SC	“PRINT SCREEN” will print an *. When pressed with the “SHIFT” key it will print all data on screen.
SCR LOCK	“SCROLL LOCK” is an inactive key.



Below are examples of “CONTROL” and “ALTERNATE” functions:

“CTRL + SCROLL LOCK/BREAK” = BREAK

This stops your program while it’s running and identifies the line where it stops.

“CTRL + NUM LOCK” = PAUSE

This stops your program from running. Press any key to continue.

“CTRL + →” = TAB

Moves cursor to next word on that line.

“CTRL + ←” = REVERSE TAB

Moves cursor to previous word on that line.

“CTRL + HOME” = CLEAR SCREEN

Removes all information on screen and moves cursor to upper left corner.

“CTRL + ALT + DEL” = SYSTEM RESET

Holding control and Alternate keys then pressing the delete keys reloads your diskette.

DOS Keyboard Usage

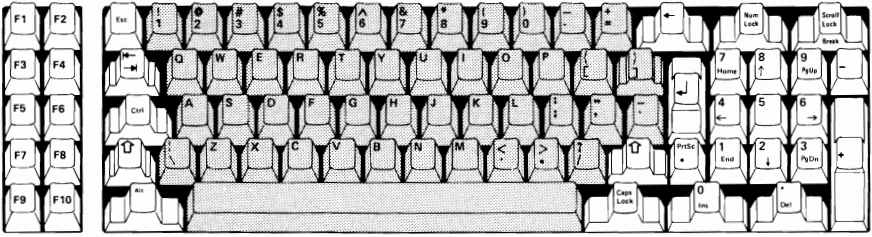

These keys are used as you would a normal typewriter.

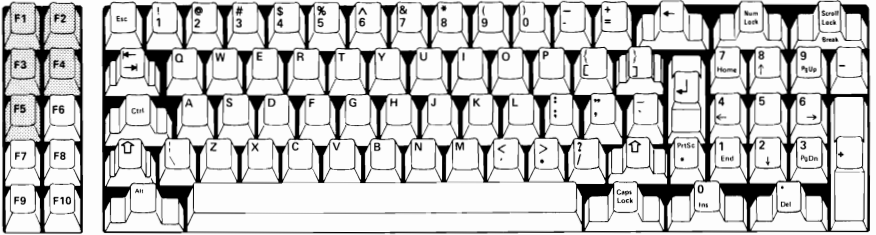

Key	Description
F1	Redisplays previously entered line, a character at a time.
F2	Enter F2 followed by a character. Screen will redisplay all of the previously entered line up to the character you entered.
F3	Redisplays entire previously entered line.
F4	Enter F4 followed by a character. Screen will skip all of the characters in the previously entered line up to the character you entered.
F5	Saves the currently displayed line for further editing.

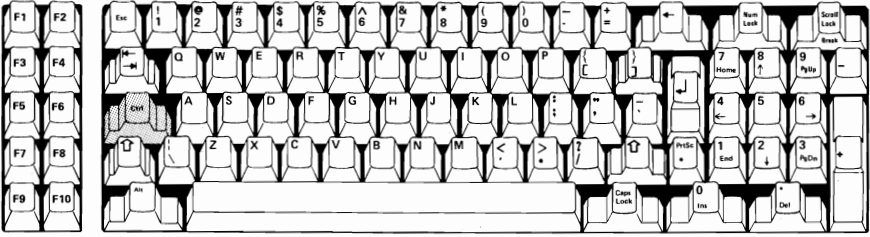

Below are a few examples of “CONTROL” functions:

“CTRL + NUM LOCK” = SUSPEND

Suspends system operation so you can read the display.
Press any key to continue.

“CTRL + PRTSC = ECHO

Echos and prints what you type and what the system
displays until you press these keys again.

“CTRL + SCR LOCK/BREAK” = BREAK

This stops your command program while it’s running.

IBM 80 CPS Matrix Printer Operations

Contents

Introduction	Printer 3-3
Control Panel Switches and Lights	Printer 3-4
Ribbon Installation	Printer 3-5
Forms Insertion	Printer 3-7
Forms Thickness Control	Printer 3-11
Left Margin Adjustment	Printer 3-12
Printer Self-test	Printer 3-13
ASCII Codes for IBM 80 CPS Matrix Printer	Printer 3-14
ASCII Control Code Chart	Printer 3-15
ASCII Character, Symbol, and Graphic Code Chart	Printer 3-16
ASCII-Character and Symbol Matrix and ASCII Number	Printer 3-17
ASCII-Graphic Matrix and ASCII Number	Printer 3-18

PRINTER

Notes:



Introduction

Your new IBM 80 CPS Matrix Printer works well with virtually any computer that uses a parallel interface. Your new Printer is a highly versatile printer featuring 80 CPS bi-directional printing, and accepts the 96 ASCII codes for characters and symbols, and 64 graphic code patterns.

Characters can be printed in any desired size; enlarged, condensed, emphasized and normal (etc.). All these characters and symbols may be printed on single or multi-part forms in widths of 4" to 10".

The brains of your IBM 80 CPS Matrix Printer is a one chip microprocessor that controls all the functions of hardware and software that are at your disposal.

Control Panel Switches and Lights

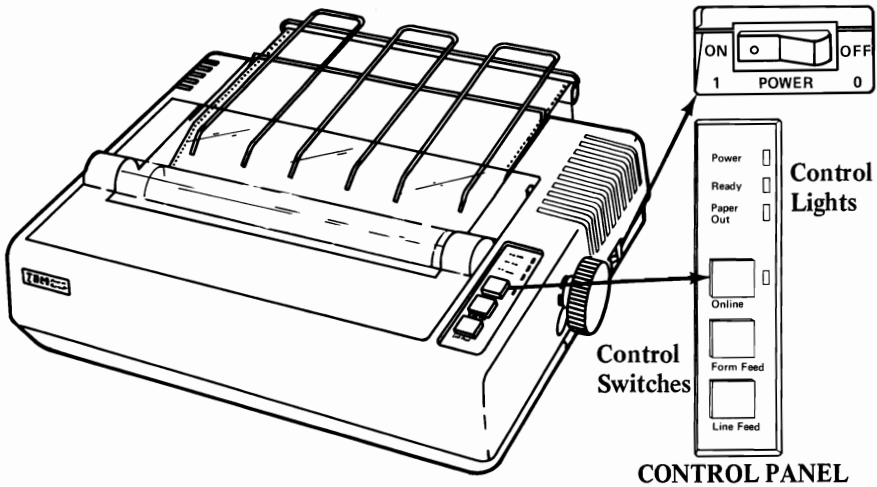

1. **“Power Switch”**—when power switch is positioned to ON, the “power” light on the control panel will be on.
2. **“Ready”**—light will be on when Printer is ready to receive data.
3. **“Paper Out”**—light will be on when paper supply is near the end, along with an audible beep.
4. **“On Line”**—light will be on whenever power switch is first positioned to ON.
5. **“On Line”**—switch controls the On Line mode. Press the switch once and Printer is Off Line and will not receive data from the host computer. Press again and Printer is returned to On Line mode.
6. **“Form Feed”**—switch is active only when Printer is Off Line and when pressed will feed the form to the next Top of Form position. The Top of Form is set by adjusting the form to the first print line before positioning the power switch to ON. Once power is applied, the Printer will automatically feed to the proper print position each time the Form Feed switch is pressed.
7. **“Line Feed”**—switch is active only when Printer is Off Line and when pressed will advance form one line. If switch is held, forms will continue to advance until switch is released.

Ribbon Installation

1. Remove ribbon cartridge from box.
2. Grasp vertical fin in center of cartridge.

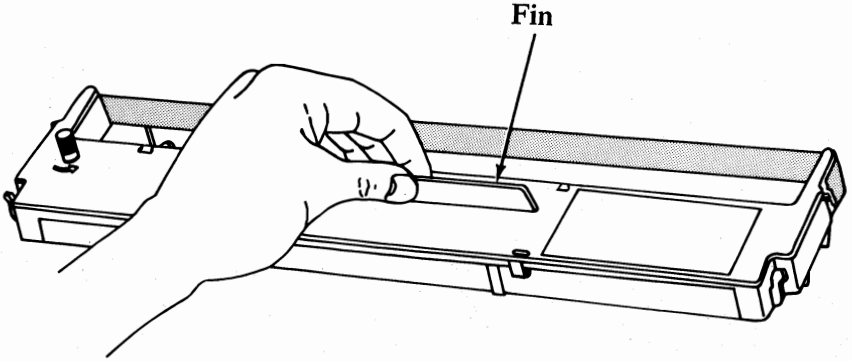

3. Guide the two tabs on left side of cartridge into two slots on the left side of printer frame.

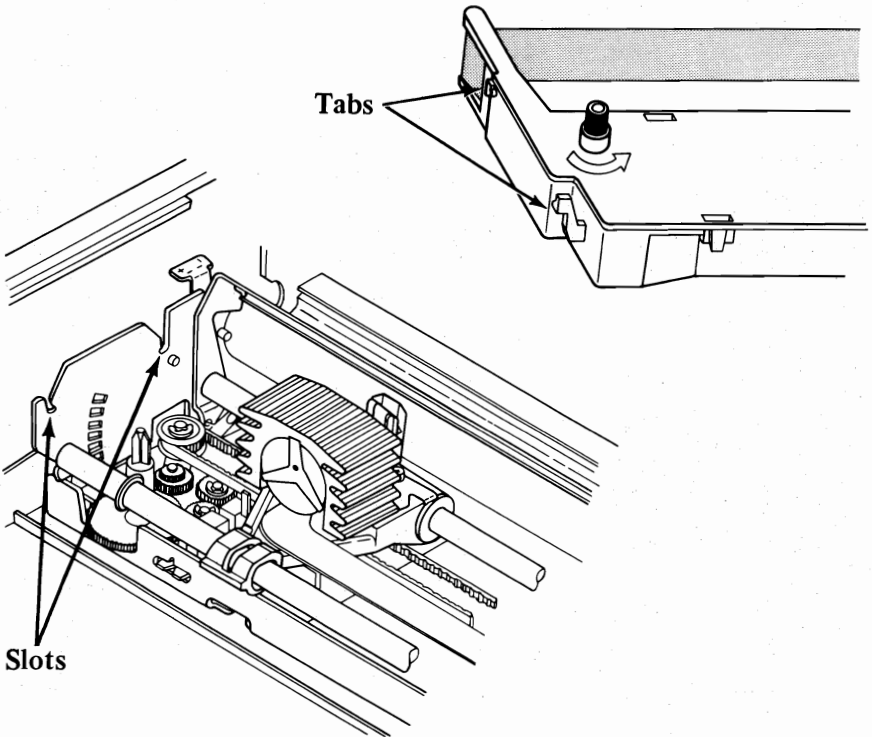

4. Press your ribbon cartridge firmly into place and turn the knob in the direction of the arrow to remove any slack in ribbon.

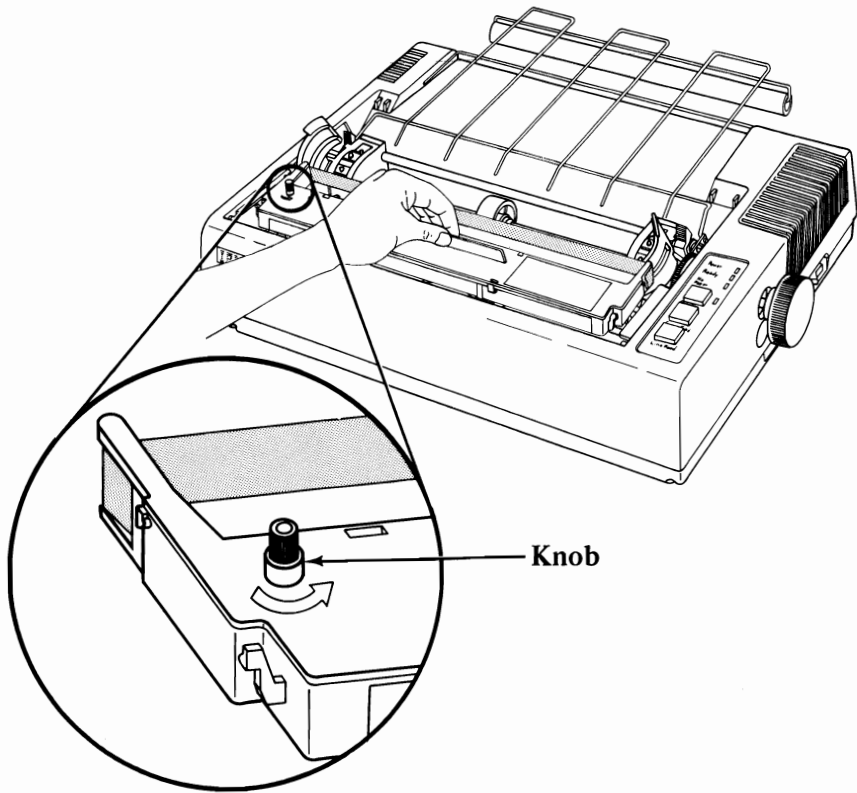

5. Using a pencil or your finger, insert the ribbon into the slot between the printhead and the ribbon shield.

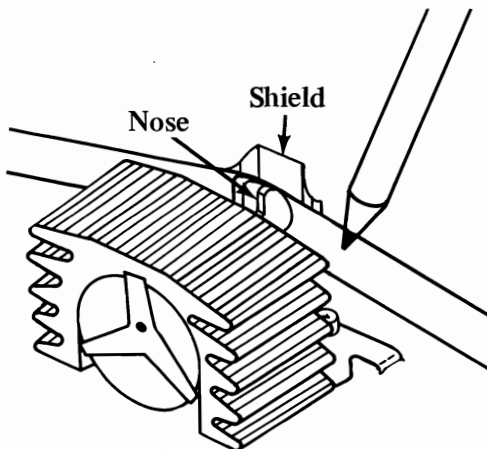

Forms Insertion

1. Raise printer access cover and lift from base as shown.

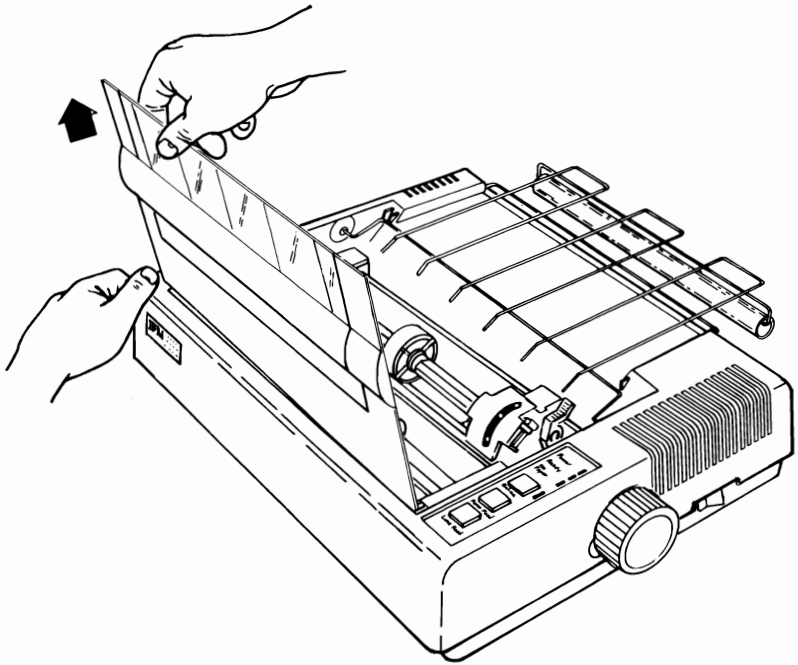

2. Position the paper behind and below the Printer. If you have a printer stand, that's ideal. The floor also works well. See example below.

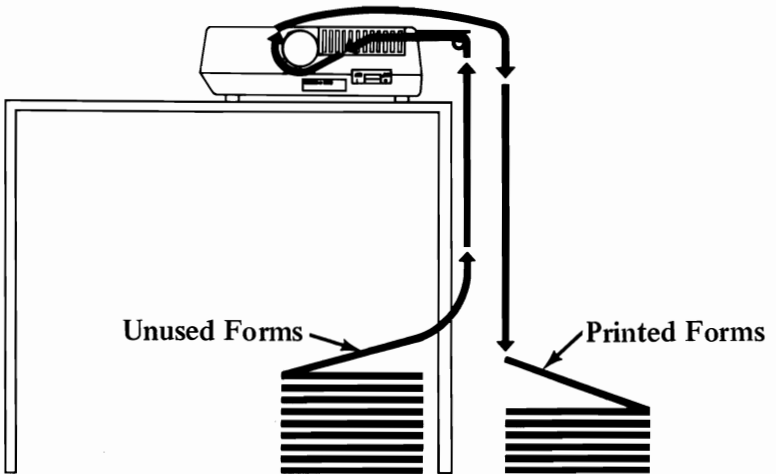

3. Move the print scale towards you, and center the forms guide roller.
4. Open the tractor covers.

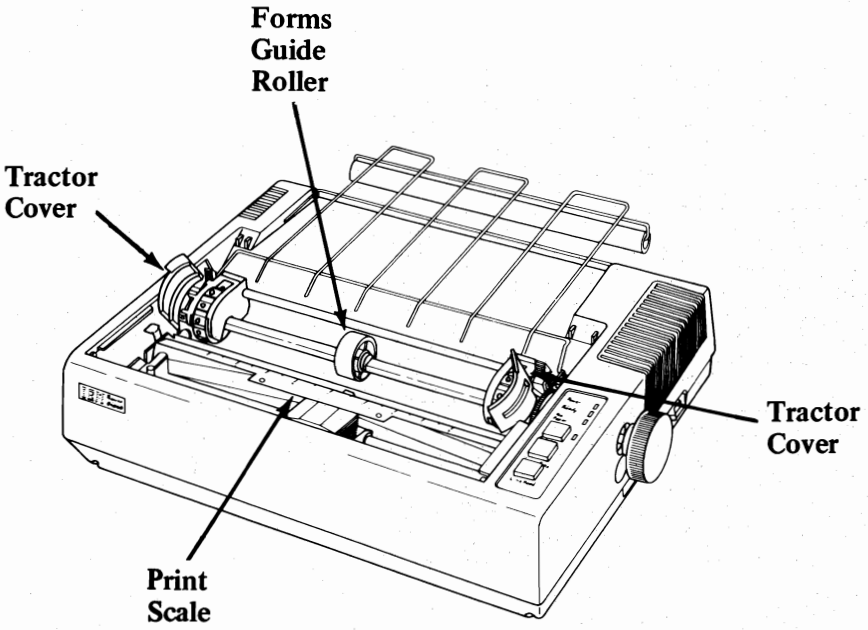

5. Insert end of forms into opening between the forms rack and plastic roller.

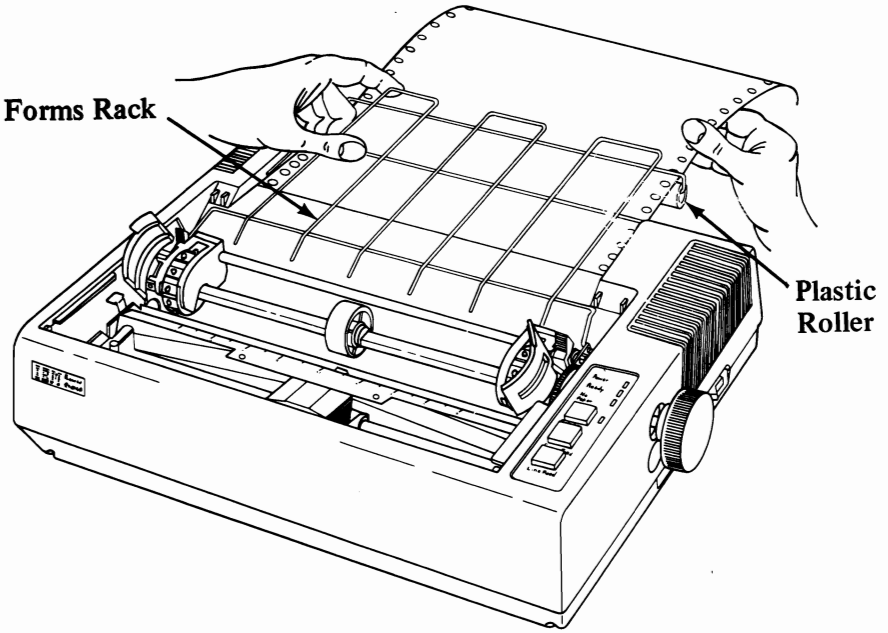

6. Guide forms into printer mechanism opening.

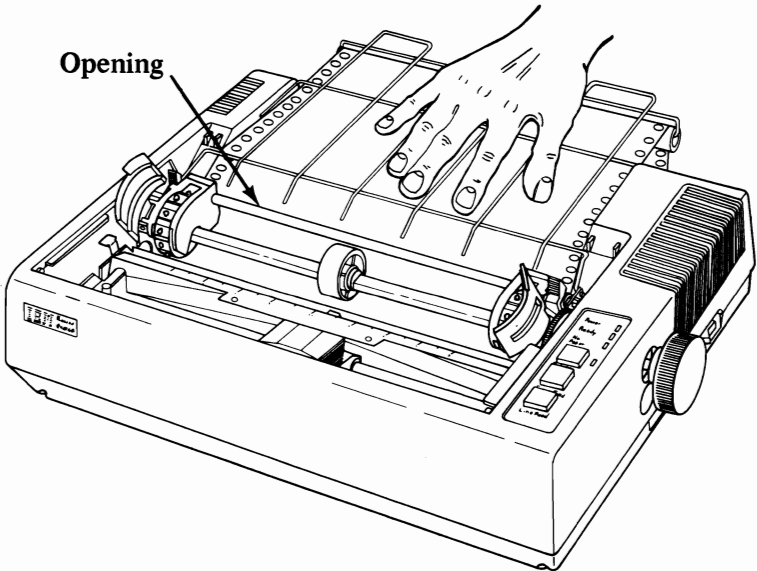

7. Push forms into opening until 3" or 4" of forms appear in the front.
8. Position the paper holes on top of the tractor pins and close the tractor covers. Adjust one or both tractors so the paper is centered, and to remove any buckle. Push the print scale up against the paper.

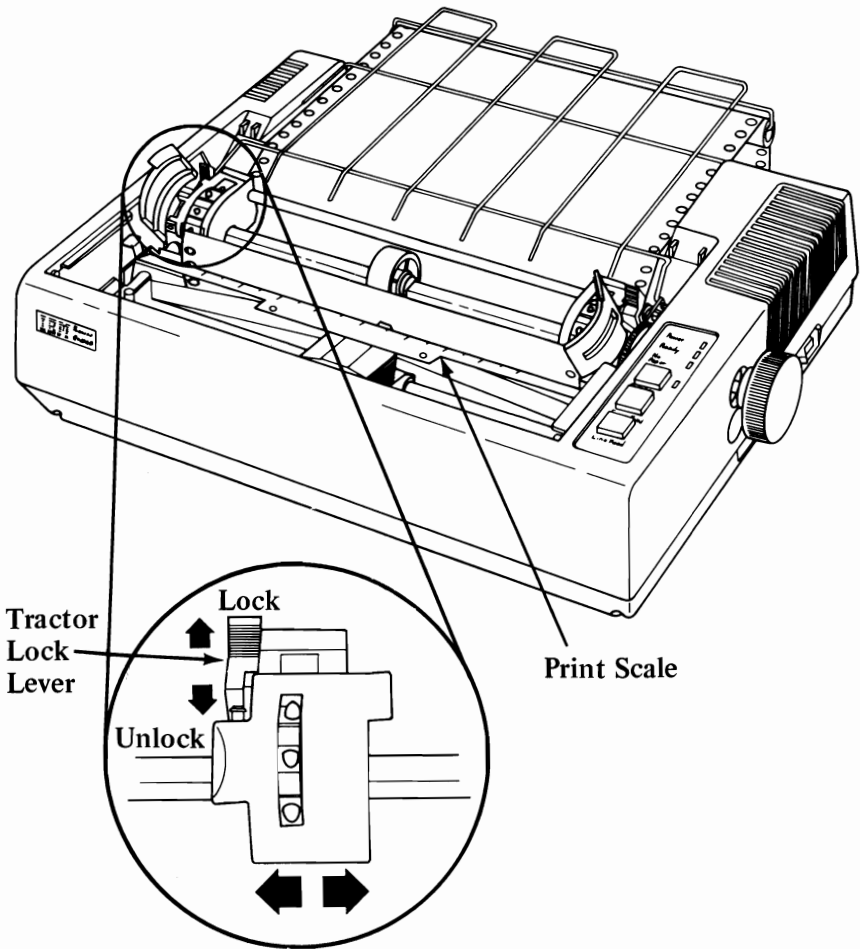

9. Roll the forms forward with the roller knob to check that forms are feeding properly.
10. Replace printer access cover.

CAUTION: Always feed forms forward, never backward or you may damage your Printer.

Forms Thickness Control

1. The Forms Thickness lever is used to adjust the position of the printhead to allow room for single or multi-part forms. For single forms, move lever towards rear. For multi-part forms, move lever towards the front.

Forms Thickness
Lever

This way for
single forms

This way for
multi-part forms

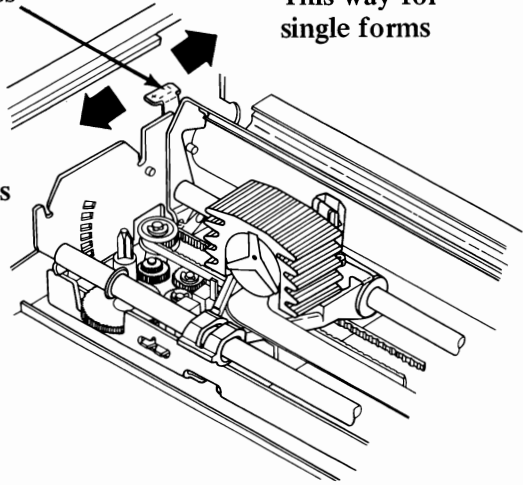

Left Margin Adjustment

1. Decide where you would like to have your print start and mark that position of the forms.

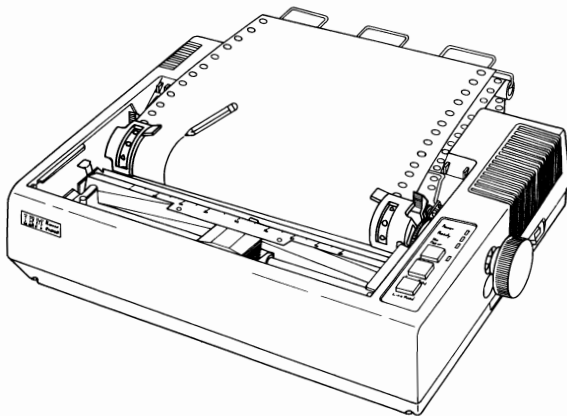

2. Release the tractor lock levers (right and left).
3. Slide the tractor assemblies along with forms and align mark with "0" position on print scale.

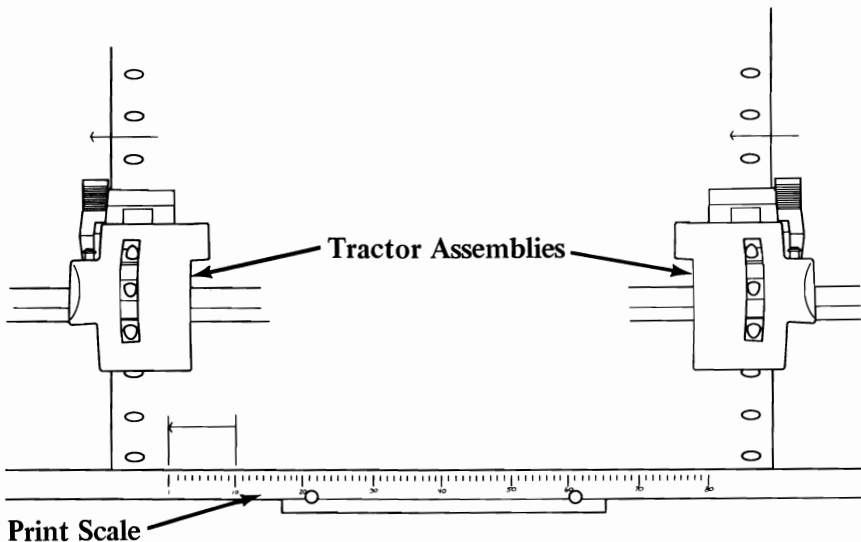

4. Lock tractor assemblies in place.

Printer Self-test

Whenever you want to verify that your Printer is operating correctly, you should perform the Printer Self-Test.

1. Position power switch on Printer and System Unit to OFF.
2. Disconnect Printer cable.
3. Position the Power Switch to ON while you press and hold the Line Feed switch.
4. Once the test starts to print, you can let go!

Note: The complete test takes about 10 minutes.

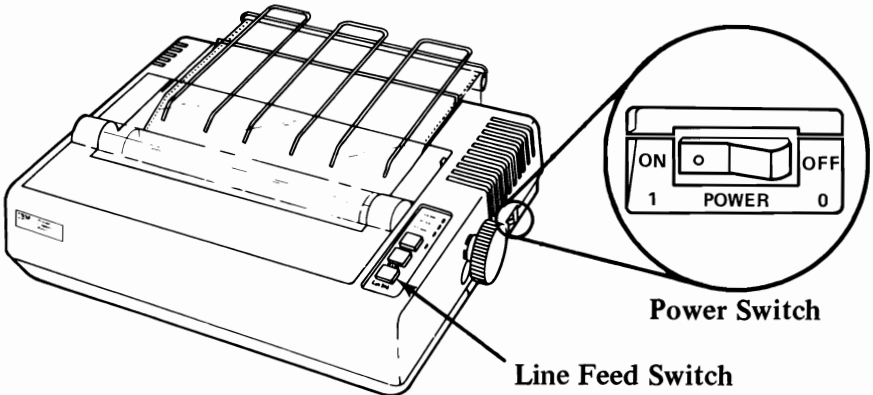

5. To stop the Self-Test, just position the Power Switch to OFF.
6. Below is a partial sample of what the printout will look like.

```
=>?@ABCDEFGHIJKLMNPOQRSTUVWXYZ[\]^_`abcdefghijklmnopqrstuvwxyz{|}~
:~?@ABCDEFGHIJKLMNPOQRSTUVWXYZ[\]^_`abcdefghijklmnopqrstuvwxyz{|}~
?@ABCDEFGHIJKLMNPOQRSTUVWXYZ[\]^_`abcdefghijklmnopqrstuvwxyz{|}~
@ABCDEFGHIJKLMNPOQRSTUVWXYZ[\]^_`abcdefghijklmnopqrstuvwxyz{|}~
ABCDEFGHIJKLMNPOQRSTUVWXYZ[\]^_`abcdefghijklmnopqrstuvwxyz{|}~
BCDEFGHIJKLMNPOQRSTUVWXYZ[\]^_`abcdefghijklmnopqrstuvwxyz{|}~
CDEFGHIJKLMNPOQRSTUVWXYZ[\]^_`abcdefghijklmnopqrstuvwxyz{|}~
DEFGHIJKLMNPOQRSTUVWXYZ[\]^_`abcdefghijklmnopqrstuvwxyz{|}~
EFGHIJKLMNPOQRSTUVWXYZ[\]^_`abcdefghijklmnopqrstuvwxyz{|}~
FGHIJKLMNPOQRSTUVWXYZ[\]^_`abcdefghijklmnopqrstuvwxyz{|}~
GHIJKLMNPOQRSTUVWXYZ[\]^_`abcdefghijklmnopqrstuvwxyz{|}~
HIJKLMNPOQRSTUVWXYZ[\]^_`abcdefghijklmnopqrstuvwxyz{|}~
IJKLMNPOQRSTUVWXYZ[\]^_`abcdefghijklmnopqrstuvwxyz{|}~
JKLMNPOQRSTUVWXYZ[\]^_`abcdefghijklmnopqrstuvwxyz{|}~
KLMNPOQRSTUVWXYZ[\]^_`abcdefghijklmnopqrstuvwxyz{|}~
LMNPOQRSTUVWXYZ[\]^_`abcdefghijklmnopqrstuvwxyz{|}~
MNPOQRSTUVWXYZ[\]^_`abcdefghijklmnopqrstuvwxyz{|}~
```

ASCII Codes for IBM 80 CPS Matrix Printer

To tell your new Printer how and what you would like to print, you must first send special coded characters from the system Unit to your Printer. These special characters are called ASCII control codes. Below, you will see a few examples on how these are used.

On the following pages you will find the complete ASCII code charts for control, character and symbols and graphic codes. You may want to keep it handy for future reference.

EXAMPLES—For the BASIC programmer

1. ASCII number 14 turns on double width mode.
 - *What to program: `LPRINT CHR$(14); "IBM Personal Computer"`
 - *What it will print: `IBM Personal Computer`

2. ASCII number 15 turns on compressed character mode.
 - *What to program: `LPRINT CHR$(15); "IBM Personal Computer"`
 - *What it will print: `IBM Personal Computer`

3. ASCII number 69 (ASCII "E") followed by ASCII number 27 (ESC. Code)
 - *What to program: `LPRINT CHR$(27)+CHR$(69); "IBM Personal Computer"`
 - *What it will print: `IBM Personal Computer`

ASCII Control Code Chart

Notes:

*These ASCII numbers may require the addition of 128 to make them work reliably. If in doubt, add 128.

**These ASCII numbers must be preceded by the Escape Code.

Control Codes require LPRINT CHR\$(#).

ASCII#	FUNCTION
** 0	NULL. Follows ESC“B” & ESC“D” as terminator for TABS.
* 0	Sets line spacing to 1/8”. Follows ESC“A”.
* 1	Sets line spacing to 7/72”. Follows ESC“A”.
* 2	Returns line spacing to wherever previously set with ESC“A”. (Defaults to 1/6” spacing.)
7	Sounds buzzer for 3-1/2 seconds.
* 10	Line Feed (LF).
** 11	Vertical Tab (VT).
* 12	Advances paper to TF (top of next form).
* 13	Carriage Return (CR).
14	Turns on DOUBLE WIDTH mode. (SO)
15	Turns on COMPRESSED CHARACTER mode. (SI)
** 17	“Selects” printer. Lets it accept data. (DC1)
** 18	Turns off COMPRESSED CHARACTER mode. (DC2)
** 19	“Deselects” printer. Can’t accept data. (DC3)
** 20	Turns off DOUBLE WIDTH mode. (DC4)
** 24	CANCELs unprinted DATA. Resets SI & SO to normal width.
27	ASCII code for ESCAPE.
* 65	ASCII “A”. Sets spacing of LF (line feed) with 0, 1, or 2.
* 66	ASCII “B”. Sets VT (vertical tabs) up to 64.
* 67	ASCII “C”. Sets FL (form length). Default is 66.
* 68	ASCII “D”. Sets HT (horiz tabs) up to 80 (or 132).
* 69	ASCII “E”. Turns on EMPHASIZED mode.
* 70	ASCII “F”. Turns off EMPHASIZED mode.
* 71	ASCII “G”. Turns on DOUBLE STRIKE mode.
* 72	ASCII “H”. Turns off DOUBLE STRIKE mode.
127	DELETes unprinted DATA. Resets SI & SO to normal width.

PRINTER

ASCII Character, Symbol, and Graphic Code Chart

CHARACTERS & SYMBOLS

GRAPHICS

NUL		SP	Ø	@	P	'	p	NUL							
0	16	32	48	64	80	96	112	128	144	160	176	192	208		
DC1	!	1	A	Q	a	q		DC1							
1	17	33	49	65	81	97	113	129	145	161	177	193	209		
2	18	34	50	66	82	98	114	130	146	162	178	194	210		
DC3	#	3	C	S	c	s		DC3							
3	19	35	51	67	83	99	115	131	147	163	179	195	211		
DC4	\$	4	D	T	d	t		DC4							
4	20	36	52	68	84	100	116	132	148	164	180	196	212		
5	21	37	53	69	85	101	117	133	149	165	181	197	213		
6	22	38	54	70	86	102	118	134	150	166	182	198	214		
BEL		7	G	W	g	w		BEL							
7	23	39	55	71	87	103	119	135	151	167	183	199	215		
CAN	(8	H	X	h	x		CAN							
8	24	40	56	72	88	104	120	136	152	168	184	200	216		
HT)	9	I	Y	i	y		HT							
9	25	41	57	73	89	105	121	137	153	169	185	201	217		
LF	*	:	J	Z	j	z		LF							
10	26	42	58	74	90	106	122	138	154	170	186	202	218		
VT	ESC	+	:	K	t	k	;	VT	ESC						
11	27	43	59	75	91	107	123	139	155	171	187	203	219		
FF	.	<	L	\	l	;		FF							
12	28	44	60	76	92	108	124	140	156	172	188	204	220		
CR	-	=	M	J	m	;		CR							
13	29	45	61	77	93	109	125	141	157	173	189	205	221		
SO	..	>	N	^	n	~		SO							
14	30	46	62	78	94	110	126	142	158	174	190	206	222		
SI	/	?	O	-	o		DEL	SI							
15	31	47	63	79	95	111	127	143	159	175	191	207	223		

ASCII-Character and Symbol Matrix and ASCII Number

32	33	34	35	36	37	38	39
40	41	42	43	44	45	46	47
48	49	50	51	52	53	54	55
56	57	58	59	60	61	62	63
64	65	66	67	68	69	70	71
72	73	74	75	76	77	78	79
80	81	82	83	84	85	86	87
88	89	90	91	92	93	94	95
96	97	98	99	100	101	102	103
104	105	106	107	108	109	110	111
112	113	114	115	116	117	118	119
120	121	122	123	124	125	126	127

PRINTER

ASCII-Graphic Matrix and ASCII Number

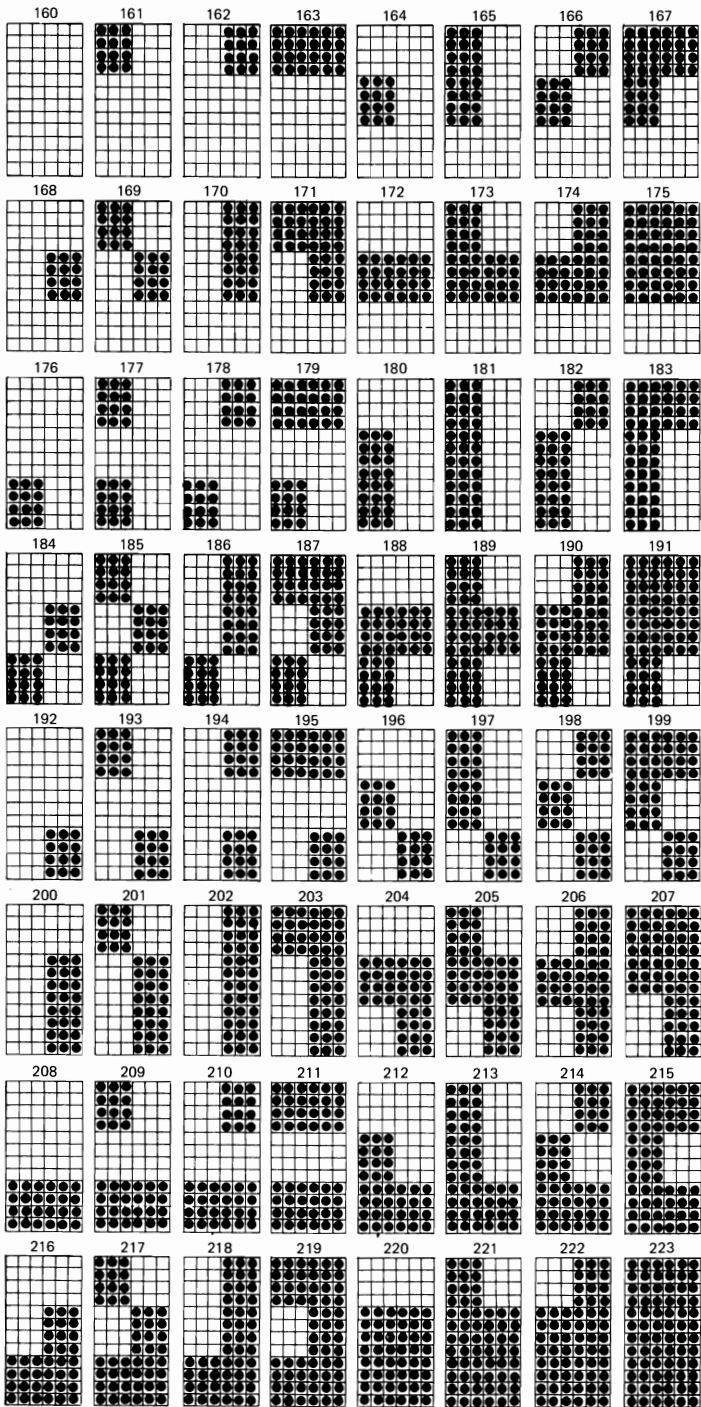

Using DOS

Contents

Introduction	DOS 3-3
Our Notation	DOS 3-4
Starting DOS	DOS 3-5
If Your Computer Is Off	DOS 3-5
If Your Computer Is On	DOS 3-6
Telling DOS the Date	DOS 3-7
The DOS Prompt	DOS 3-9
Changing the Default Drive	DOS 3-10
Some Keys You Will Use with DOS	DOS 3-12
Characters That Look Alike—Oh's and Zeros, Ones and Els	DOS 3-12
The Spacebar	DOS 3-13
The Shift and Caps Lock Keys	DOS 3-14
To Enter a Command	DOS 3-15
To Stop a Command	DOS 3-15
To Correct a Typing Mistake	DOS 3-16
To Stop the Screen Long Enough to Read It	DOS 3-17
To Print What Is On the Screen	DOS 3-17
To Print Whatever You Type	DOS 3-18
To Start DOS Again	DOS 3-18
About Diskettes	DOS 3-19
Tracks, Bytes, and Sectors	DOS 3-20
Careful Does It	DOS 3-21
Write Protect Notch	DOS 3-22
An Important Exercise: Backing Up Your DOS Diskette	DOS 3-23
Before You Begin	DOS 3-23
If You Have One Drive	DOS 3-24
If You Have Two Drives	DOS 3-31
What's on the DOS Diskette?	DOS 3-36
Files and Filenames	DOS 3-37
Global Filename Characters	DOS 3-41
An Exercise: Listing the DOS Diskette Files	DOS 3-44
DOS Diskette Files	DOS 3-46

Things You Can Do with DOS	DOS 3-47
Summary of Commands	DOS 3-47
FORMAT—Getting a Diskette Ready to Be Used	DOS 3-50
Before You Begin	DOS 3-50
If You Want DOS on Your Diskette	DOS 3-51
If You Do Not Want DOS on Your Diskette	DOS 3-52
Formatting Several Diskettes	DOS 3-53
DIR—Finding Out What Is on a Diskette	DOS 3-54
Before You Begin	DOS 3-54
To List All the Files	DOS 3-54
To List One File	DOS 3-56
DISKCOPY—Backing Up a Diskette	DOS 3-58
Before You Begin	DOS 3-58
Protecting Your Original Diskette	DOS 3-59
Backing Up with One Drive	DOS 3-60
Backing Up with Two Drives	DOS 3-62
COPY—Backing Up One File	DOS 3-65
Before You Begin	DOS 3-67
Copying a File to the Same Diskette	DOS 3-67
Copying a File to Another Diskette Using One Drive	DOS 3-68
Copying a File to Another Diskette Using Two Drives	DOS 3-72
TYPE—Displaying What Is in a File	DOS 3-74
Before You Begin	DOS 3-74
Here's How You Do It	DOS 3-74
RENAME—Changing a File's Name	DOS 3-76
Before You Begin	DOS 3-76
ERASE—Removing a File from a Diskette	DOS 3-79
Before You Begin	DOS 3-79
Global Filename Characters	DOS 3-81
MODE—Shifting the Display on the Screen	DOS 3-82
Before You Begin	DOS 3-82
Shift Right	DOS 3-82
Helps and Hints	DOS 3-84
Summary	DOS 3-86

Introduction

DOS stands for Disk Operating System. People are about evenly divided between saying d - o - s or as one word, *doss* (to rhyme with *hoss*).

DOS is a collection of programs for your IBM Personal Computer that is supplied to you on the *DOS Diskette*.

These programs process commands to let you manage information. They also help you manage the hardware resources (for example, the diskette drives and screen) of your computing system. DOS also does some stuff inside the machine, but since it does it for you, we won't describe it in this chapter.

This chapter tells you about starting DOS, about the diskettes and making a copy of the DOS Diskette. Then we will step you through examples of the DOS commands you will use most often. After you've learned how to use these commands, you will probably want to refer to the *IBM Personal Computer Disk Operating System* book for more information on these and other commands, and on other DOS programs.

It is important that you copy your DOS Diskette. In fact, we suggest you do it several times. See "An Important Exercise" for instructions.

Our Notation

DOS will let you type with lowercase or uppercase letters (or a combination of both).

This chapter shows what you type in lowercase letters because you will probably find it easier to type this way. For example,

```
dir a:*.*
```

shows what you should type.

We will show the names of commands, programs, and files in capital letters—like 80PRICES.AVG—both to make it easier for you to read and because that's how these names will be shown to you on the screen.

Starting DOS

You will usually want to start DOS whenever you start your computer. For example, you must have DOS “loaded” before you can start Disk BASIC or Advanced BASIC programs.

Starting DOS or *loading* DOS means that a copy of the DOS programs are read from the DOS Diskette and placed in the computer’s memory. Once the computer finishes its usual self-checks, you will hear the diskette drive whirring and clicking while the DOS programs are being read and transferred to memory.

DOS tells you it is ready when it asks you for the current date. After that, DOS is ready for you to type a *command*—that is, to tell DOS what you want it to do.

Let’s look at starting DOS, step-by-step.

There are two ways to start DOS, depending on whether your computer is off or on.

If Your Computer Is Off

- 1 Insert the DOS Diskette into drive A: and close the diskette drive cover.

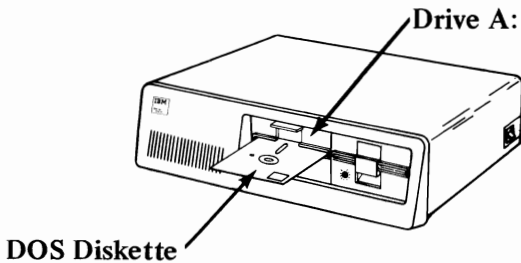

- 2 Turn on the printer, if you have one, a video monitor or TV, and then the computer.
- 3 There will be a pause (from 3 to 45 seconds) while the system checks itself out. Then you will hear the diskette drive clicking while DOS is being read and transferred.

If Your Computer Is On

- 1 Insert the DOS Diskette in drive A: and close the drive door.

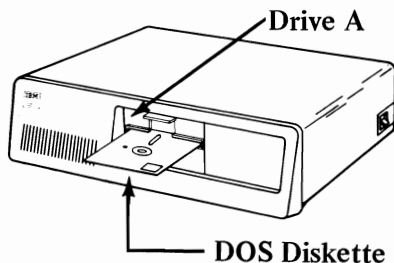

- 2 Press and hold Ctrl and Alt, and then press Del. Then release them all:



- 3 You will see the diskette drive "in use" light on while DOS is being read, and you may hear some clicks and whirs.

Note that you will see these three keys used again in the section "To Start DOS Again." This is the same—that is, use Ctrl + Alt + Del to start DOS if your computer was already on and you were running something else or to restart DOS. This is called *System Reset*.

Telling DOS the Date

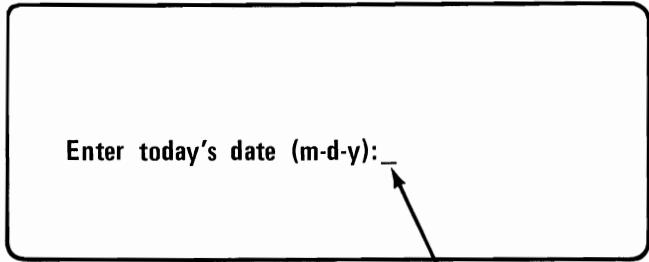

When DOS is loaded and ready, you will see something similar to this on the screen:



The cursor shows where the first number you type will appear.

It's an excellent idea to fill in the current date whenever you start (or restart) DOS because then any files that you create or change will have the correct date stored in the file directory—helpful information months later, if you can't remember exactly which file has the most current information. (You'll learn about files and directories in a little bit.)

To set the date, use the number keys across the top of the keyboard:

- 1 Type one or two numbers between 1 and 12 for the month.
- 2 Type a dash  or a slash  .
- 3 Type one or two numbers between 1 and 31 for the day.
- 4 Type another dash or slash.
- 5 Type two numbers between 80 and 99 for the year.
- 6 Press the Enter key  .

For example, suppose the current date is June 8, 1982.

Type this: **6-8-82**
or this: **6/8/82**
or this: **6-08-82**
or this: **6/08/82**
or this: **06-08-82**
or this: **06/08/82**
or this: **06/8/82**

DOS checks the date that is typed. If the date that is typed does not check out, DOS displays this message:

Invalid date
Enter today's date (m-d-y):_

These are some dates that would not check out:

Date	Reason
060882	No dashes or slashes
APR-02-80	Letters instead of numbers
13-08-83	Month too big
9-32-82	Day too big
10 15 82	Spaces, not slashes or dashes

If DOS tells you that the date is invalid, try again.

The DOS Prompt

After you have entered the date, DOS displays this:

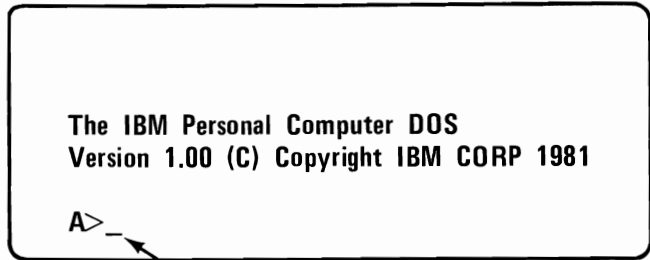

The cursor is here.

A> is the DOS *prompt*. A prompt tells you that it is your turn to type information, that is, to tell DOS what to do by entering a command.

This prompt tells you some other things, too, besides that DOS is waiting for you to enter a command.

First of all it tells you that it is **DOS** that is waiting. Other programs have different prompts; for example, BASIC's prompt is: **Ok**. Ok lets you know that you should respond with a **BASIC** command.

The second thing that **A>** tells you is that **A:** is the *default drive*. A default drive is the diskette drive that DOS assumes will contain the diskette or file you specify in a command, unless you explicitly type another diskette drive, like **B:**. Another name for the default drive is the *current* drive.

Changing the Default Drive

You can *change* the default drive. To do this, just type the new drive designator following the A> prompt, and press Enter.

For example, to make drive B: the default drive, type:

b:

and press the Enter key. Here's what this looks like on the screen:

```
A>b:  
B>_
```

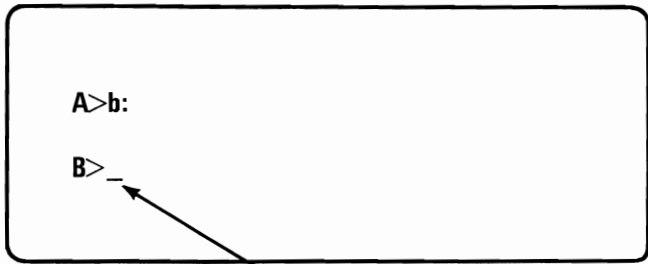

The cursor is here.

Note that now the prompt is B>—just what we wanted. Now DOS will look at the diskette in drive B: whenever you specify a file without the drive specifier.

You can change back by typing a:. Here's the screen now.

```
B>a:  
A>_
```

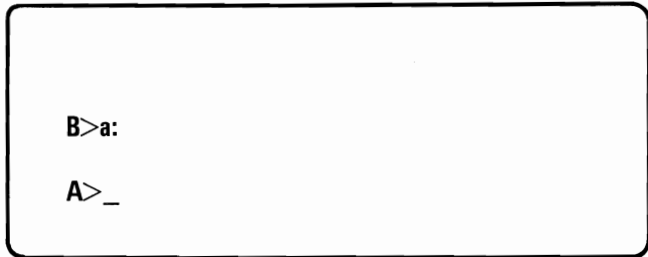

Try this too.

So far we have discussed:

- how to get DOS started
- the DOS prompt and default drive

Let's take a closer look at the keyboard and diskettes before we go any further.

Some Keys You Will Use with DOS

In addition to the keys you'd find on a typewriter, your keyboard has some special keys you'll use with DOS.

Before we get to the special keys, here are a few differences between your keyboard and a typewriter, that you need to know.

Characters That Look Alike— Oh's and Zeros, Ones and Els

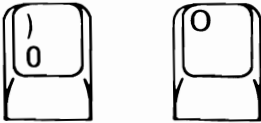

Computers are fussy about the number zero and the letter O—they want what they want, and you can't fool them into taking the wrong one. Make sure you type the right key in commands and filenames.

On our printer, the letter O looks a little squarer than the number 0.

On our screen, the number zero has a diagonal line through it, something like this: Ø

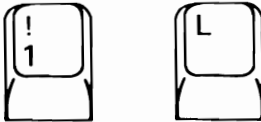

If you are used to typing a lowercase L for the number 1 (if you have used a portable typewriter a lot, for example), you'll have to break that habit.

Again, the computer knows the difference. Use the number key when the number 1 is required, as in a filename such as DATA123. (Now if you were to use lowercase L when creating a filename, that's okay. Just be *sure* to use it again when you want to use that file!)

The Spacebar

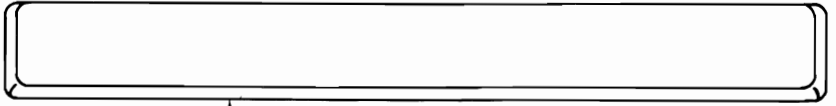

This is the spacebar. Use it to put a blank (a space) in a line you are typing. Sometimes people want to use it for moving the cursor—it will move the cursor, but it will also *replace* any characters it moves across with blanks.

To the computer, blanks are important; a blank is as much a character as A or B. Many times blanks are used to separate what you type for the computer just as we use them to separate words in everyday writing. You have to make sure when you're typing that the computer allows a blank. Otherwise, it may not understand what you have typed.

The Shift and Caps Lock Keys

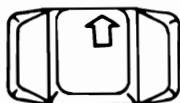

There are two shift keys on the keyboard, located about where you find them on a typewriter keyboard.

Use them to type uppercase (capital) letters or to type the symbol shown in the upper position on the keytop for all keys except the numeric keypad on the right. That's just as you would expect.

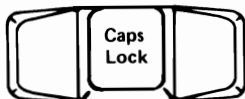

The Caps Lock key lets you type capital letters (only) until you press it again. Only the letter keys are affected.

You still have to press one of the shift keys to type the symbols in the upper positions of the number keys at the top of the keyboard. For example, you must press the shift key to type a #.



Unlike a regular typewriter, pressing one of the shift keys  does not get you out of Caps Lock mode. You must press the Caps Lock key again to type lowercase letters. Or you press a shift key momentarily, to type a lowercase letter.

Remember that DOS will accept lowercase letters in all commands and filenames; so you'll be using these shift keys mostly for special symbols.

To Enter a Command

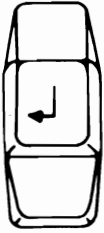

Use the Enter key when you have finished typing a whole command. After you press the Enter key, the command starts (sometimes, you will see the word “executed” instead of “started”).

To Stop a Command

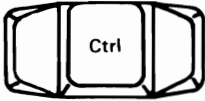

+

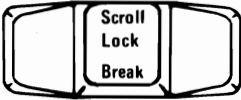

Press and hold the Ctrl (Control) key and then press the Break key. Then release both keys to stop a command from finishing its job normally. (This is sometimes called “terminating” a program.)

DOS shows you a prompt; then you can type your next command.

To Correct a Typing Mistake

There are several ways to correct a mistake that you notice *before* you press the Enter key.

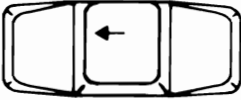

One of the easiest is use the Backspace key to move the cursor backward, under the leftmost wrong character. The Backspace key deletes characters as it moves the cursor to the left. (The Backspace key is located on the top row next to the Num Lock key.)

Now type the correct characters, and press the Enter key when everything is the way you want it.

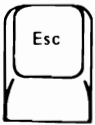

Another way, if the line is just too messed up to worry about, is to press the Esc (Escape) key. A Backslash (\) is displayed, and the cursor moves down one line on the screen. This cancels the messed-up line and you can then type the command correctly.

More ways to correct typing mistakes (“editing”) are discussed in the *Disk Operating System* book; but these two keys should be enough to get you started.

To Stop the Screen Long Enough to Read It

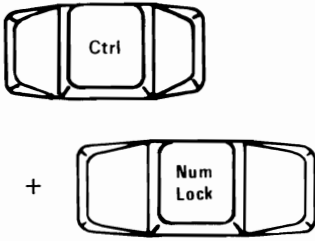

If information is appearing on the screen too fast for you to read, press and hold the Ctrl (Control) key and then press the Num Lock (Number Lock) key. Then release both of them.

When you are ready to see some more information, press *any* key.

(“Scrolling” is the term used to describe how a line of information is displayed on the screen and then is pushed upward until it is pushed off the top of the screen by new lines of information being displayed at the bottom.)

To Print What Is on the Screen

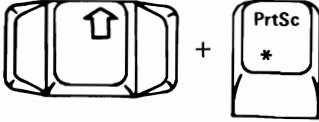

If you have a printer and want to print what is currently on the screen, first make sure the printer is on. Then press and hold either shift key and then press the Prtsc (Print screen) key; and then release both of them.

What is printed is often called a “hard copy.”

To Print Whatever You Type

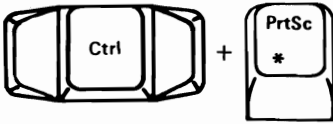

If you have a printer and want to print whatever you type and what the computer displays, press and hold the Ctrl (Control) key and then press the Prtsc (Print screen) key. Then release them both. Now, each time you press the Enter key or the computer displays a line, the line will be printed ("echoed" on the printer).

To stop echoing to the printer, press the Ctrl and Prtsc keys again.

This is *different* from shift and Prtsc. Shift and Prtsc prints a whole screen's worth and then is done. But Ctrl and Prtsc prints one line at a time, line after line, until you press Ctrl and Prtsc again to stop the printing.

To Start DOS Again

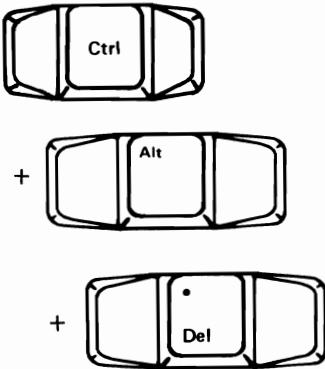

If you want to start DOS over from the beginning, put your DOS Diskette into drive A:. Then press and hold down the Ctrl (Control) and Alt (Alternate) keys and then press the Del (Delete) key. Then release all three. Remember, you may see this called *System Reset*.

After a bit, you'll see the DOS startup message.

About Diskettes

Your IBM Personal Computer uses 5-1/4 inch (133 mm) *diskettes* for storing information. (You may also have heard the terms “floppy diskette,” “mini-floppy,” or “disk”—we will use “diskette.”)

These diskettes can hold about 160,000 characters (would you believe 163,840!) of data and/or program information. That’s about 110 pages from a book.

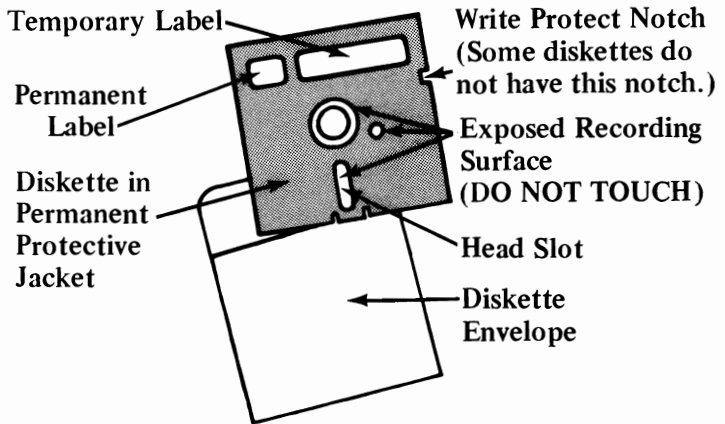

The permanent protective jacket (which is black) contains a flexible diskette that is coated with a magnetic substance. When in use, the diskette spins inside the jacket. The read/write head comes into contact with the recording surface through the long hole in the protective jacket, called the *head slot*. Information is written to or read from the magnetic surface of the diskette, similar to the way an ordinary tape recorder operates.

The information on a diskette can be read by the computer as often as it needs, or the computer can write new information on the diskette in an unused space.

Or the computer may *replace* old information with new information by writing over it. In this case, the old information is erased and can no longer be read. Similarly, if you record a Chicago Symphony program on an Elvis Presley tape, you can no longer listen to Elvis.

Tracks, Bytes, and Sectors

Information is written on the diskette along concentric circles called *tracks*. The read/write head of the diskette drive moves back and forth from one track to another as the diskette spins over it. This lets the head find certain data to read or find a place to write some new information.

There are 40 tracks on a diskette, numbered from 0 to 39. DOS reserves portions of track 0 of each diskette. The rest of the diskette is available for your information and for a copy of the DOS system, if you want.

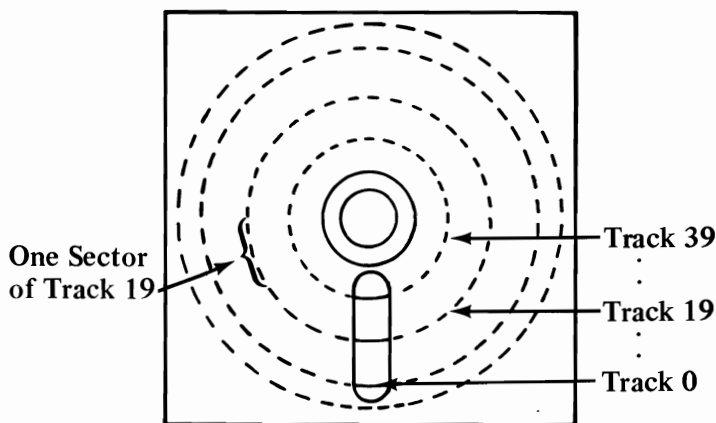

You'll also hear the words *byte* (pronounced like "bite") and *sector* used in talking about diskettes.

Space on a diskette (and in the computer's memory, too) is measured in *bytes*. One byte can hold one character; thus, the 5-1/4 inch diskettes can hold about 160,000 bytes, or 160,000 characters.

Each track is divided into eight sectors that are 512 bytes long. One or more sector's worth of information can be sent back and forth between the computer and a diskette at one time.

Information on a diskette can be quickly located by its sector and track numbers—just as an address number (sector number) and street name (track number) are used to find a particular house in a town.

Normally, you won't have to know about an information's sector and track numbers—DOS takes care of that for you. You give your information a name, called a *filename*, and DOS assigns it to a place on your diskette.

“Files and Filenames” are discussed after we tell you a little more about protecting the information on your diskettes—especially your DOS Diskette.

Careful Does It

Be careful with your diskettes. See Section 4 for information about handling your diskettes.

We'd like to emphasize these things here:

- Do not touch the exposed recording surfaces.
- Protect the diskettes from dust by putting them back in their envelopes *as soon as* you remove them from the diskette drive.
- Store often-used diskettes in their envelopes. Don't lay heavy objects on top of them. If you stand them on edge, make sure they aren't bending or sagging.
- Store seldom-used diskettes in storage boxes, away from heat and magnetic field sources such as telephones, dictation equipment, and electronic calculators.
- Because each piece of information occupies such a tiny spot on the diskette, small scratches, dust, food, or tobacco particles may make the information unusable.

Take care of your diskettes because running your computer without programs and data is like running your car without gasoline.

Write Protect Notch

Besides making sure your diskettes aren't scratched or dirtied, you can make sure the computer cannot write over information already on a diskette.

If your diskette has no write protect notch, it is already *write protected*. This means that the computer cannot store (write) any information on it. Your DOS Diskette does not have a write protect notch.

If your diskette has a *write protect notch*, you can cover this notch with a tab supplied with the diskette. Then the computer *cannot* write on the diskette. In this case, information can only be read from the diskette; information already on the diskette cannot accidentally be erased by being overwritten with new information.

Important diskettes (for example, purchased program diskettes) are often protected this way.

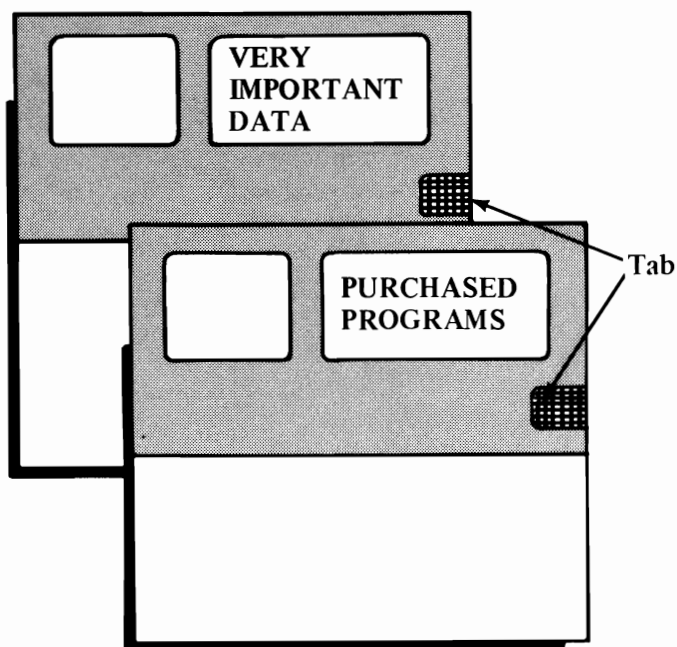

Just for Reading

If you are *certain* it is okay to write on a write-protected diskette, you can peel off the tab so that the computer can write on it.

An Important Exercise: Backing Up Your DOS Diskette

Making a copy of your DOS Diskette should be one of the first things you do with your IBM Personal Computer after you get DOS. That way you won't be "shut down" if your DOS Diskette becomes misplaced or accidentally damaged. This copy is called a "back-up" and making the copy is usually called "backing up."

Before You Begin

You will need:

- Your DOS Diskette.
- A diskette, preferably brand new, that will become the back-up. (If the diskette has been used before, *make sure* that it does not contain information you will need again. This procedure will destroy any information that was stored on the diskette.)

We will refer to this diskette as the "back-up" diskette in the two examples that follow.

Read through the instructions before you start. There are two sets of instructions depending on whether you have one diskette drive or two.

If You Have One Drive

- 1 Make sure DOS is ready and **A>** is displayed.
- 2 Insert your DOS Diskette into the drive if it is not already there.
- 3 Type this:

format b:

and press the Enter key.

- 4 This message is displayed:

**Insert new diskette for drive B:
and strike any key when ready**

**BE CAREFUL NOT TO TOUCH THE KEYBOARD
ACCIDENTALLY UNTIL THE DISKETTES HAVE
BEEN SWITCHED.**

- 5 Remove the DOS Diskette and keep it handy.
- 6 Insert the back-up diskette into the drive.
- 7 Press a key to tell DOS that the diskettes have been changed.

8 Now this message is displayed:

Formatting...

and after a while, the rest of the message appears:

Formatting... Format complete
Format another (Y/N)?_

The cursor

9 Type this:

n

You don't have to press the Enter key.

10 DOS now shows you the prompt: **A>**
The back-up diskette is now ready for the copy part of these instructions.

11 Remove the back-up diskette, but don't put it away.

12 Insert the DOS Diskette into the drive.

13 Type this:

diskcopy

and press the Enter key.

- 14** This message appears:

Insert source diskette in drive A
Strike any key when ready

Because the DOS Diskette (the “source diskette”) is already in drive A:, you do *not* need to exchange diskettes.

- 15** Press a key.

- 16** Now this message is displayed:

Insert target diskette in drive A
Strike any key when ready

Before touching any key:

- 16A** Remove the DOS Diskette.
- 16B** Insert the back-up diskette. This is the “target diskette”.
- 16C** *Now* press a key to tell DOS the right diskette has been inserted.

- 17** In a little bit, this message is displayed:

Insert source diskette in drive A
Strike any key when ready

Do this:

17A Remove the back-up diskette.

17B Insert the DOS Diskette.

17C Press a key only after the DOS Diskette is in the drive.

- 18** Keep repeating steps 16 and 17 until this message appears:

Copy complete
Copy another? (Y/N)

- 19** Type this:

n

You don't have to press the Enter key.

- 20** Type this:

diskcomp

and press the Enter key.

21 This message is displayed:

Insert first diskette in drive A
Strike any key when ready

22 Press a key.

Your DOS Diskette back-up is one of the diskettes you want to compare and it is already in the drive.

23 Now this message appears:

Insert second diskette in drive A
Strike any key when ready

Do this:

23A Remove the back-up diskette.

23B Insert the DOS Diskette.

23C Press a key.

24 Now this message is displayed:

Insert first diskette in drive A
Strike any key when ready

Do this:

24A Remove the DOS Diskette.

24B Insert the back-up diskette.

24C Press a key.

25 Keep doing steps 23 and 24 until this is displayed:

Diskettes compare ok
Compare more diskettes? (Y/N)

26 Type this:

n

27 The DOS prompt, **A>**, is displayed.

Remove the diskette from the drive.

With a felt tip pen, label and date your “DOS DISKETTE BACK-UP.”

Store the original DOS Diskette properly and use the back-up in your daily operations. In the rest of this chapter, we will still call the back-up diskette “your DOS Diskette,” because it is the *same* as your DOS Diskette.

If You Have Two Drives

- 1** Make sure DOS is ready and **A>** is displayed.
- 2** Insert your DOS Diskette into drive A: if it is not already there.
- 3** Insert the back-up diskette into drive B:.
- 4** Type this:

 format b:

and press the Enter key.
- 5** You will see this message:

**Insert new diskette for drive B:
and strike any key when ready.**

- 6** Press a key, because the back-up diskette should already be in drive B: (step 3).

7 You will see this message:



Formatting...

and after a little whirring and clicking in drive B:, the rest of the message appears:



Formatting... Format complete

Format another? (Y/N)? 

The cursor

8 Type this:

n

You do not have to press the Enter key.

9 Now the DOS prompt appears: **A>**

The new diskette is now formatted; that is, it is ready to have a copy of the DOS Diskette information written on it.

10 Type this:

diskcopy a: b:

and press the Enter key.

- 11** You will see this message:

Insert source diskette in drive A
Insert target diskette in drive B
Strike any key when ready

Your diskettes have already been inserted into these drives. (That is, the DOS Diskette is in drive A: and the back-up diskette is still in drive B:.)

- 12** Press any key to tell DOS the diskettes are ready.

Now the entire diskette is being copied from the diskette in drive A: to the diskette in drive B:.

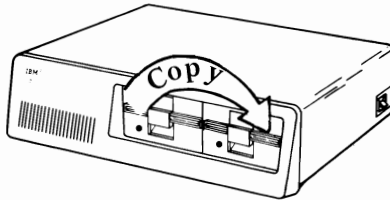

You will see one “in use” light go on and then the other.

- 13** When the copy has been made, you will see a message similar to this:

Copy complete
Copy another? (Y/N)

—
↖
The cursor is here.

14 Type:

n

The DOS prompt, **A>**, is displayed.

15 Just to make sure the copy is the same as the DOS Diskette, we will compare them.

Type this:

diskcomp a: b:

and press the Enter key.

16 This message is displayed:

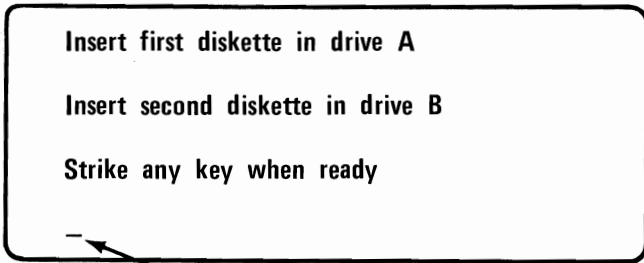

Insert first diskette in drive A

Insert second diskette in drive B

Strike any key when ready

—

The cursor is here.

17 Press any key to tell DOS the diskettes are ready.

Again you will see the “in use” lights come on and hear some clicking. When the comparison is complete, this message is displayed:

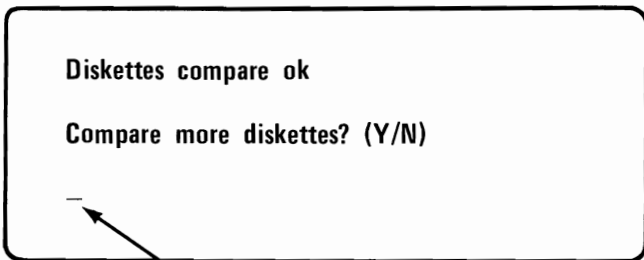

Diskettes compare ok

Compare more diskettes? (Y/N)

—

The cursor

18 Type this:

n

19 Remove both diskettes.

Label and date the back-up diskette. Use a felt tip pen. Store the original DOS Diskette properly and use the back-up diskette in your daily operations.

What's on the DOS Diskette?

If you've read this far and done the exercise, you have made a copy of your DOS Diskette for everyday use and you've learned something about diskettes.

Let's take a closer look at the DOS Diskette to find out what information is on it. Before we get to the exercise to do this, we will discuss how information is structured on a diskette.

Files and Filenames

Related information on a diskette is grouped into *files*, just as information in a book about a particular topic may be grouped into a chapter.

Some examples of files:

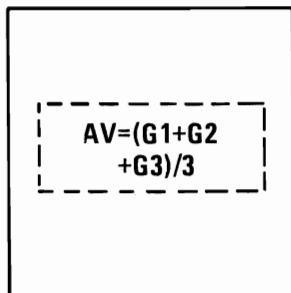

A file containing a program to calculate bowling team averages.

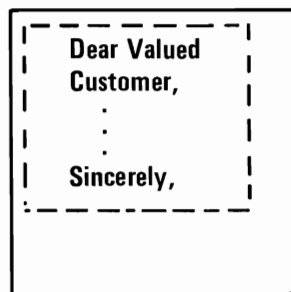

A file containing the text of a form letter your company sends out.

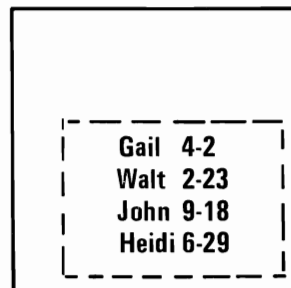

A file containing names and birthdays of your friends.

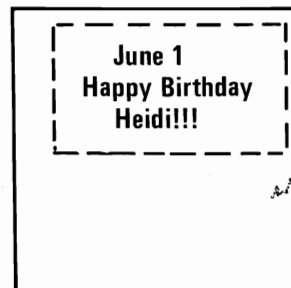

A file containing a program to print a birthday message to all your friends born this month.

Files are used so that DOS can find specific information easily, so that information that isn't needed isn't taking up room in the computer too. (For example, you don't need your bowling team averages at the same time as you need the form letter.)

You usually have a number of files on a single diskette. You can have up to 64 files on a diskette. Sometimes the files on one diskette are related to each other (like the programs and data files to keep track of a company's inventory); and sometimes the files have been put on whatever diskette was handy.

It doesn't matter what combination of files is on a diskette. What matters is that each file has a unique name.

That means that every name on a diskette has to be different—but you can have the same name on two different diskettes.

For our examples a little earlier, the names of these files might be:

**BOWL
LETTER
BIRTHDAY
BIRTHDAY.BAS**

A file's name is made up of a *filename* and an *extension*.

In DOS, *filenames* are from one to eight characters long. The characters in a filename can be:

- the letters of the alphabet
- the numbers 0 through 9
- and these special characters—

\$ # & @ ! % () - { } < > ' _ \ ^ ~ | ' ,

A filename can be followed by an optional short name called an *extension*. An extension starts with a period, has one, two, or three characters, and follows immediately after the filename.

Here are some filenames with extensions:

81PRICES.JUL
81PRICES.AUG
AVRG.\$8%
WEATHER.80

IMPORTANT: If a filename is followed by an extension, you *must* use both parts when telling DOS about that file.

Bad, Okay, and Good Names for Files

With all the possibilities, filenames can be unusual, to say the least.

DOS likes names that follow the rules. These files have names that DOS will not accept:

Name	Why DOS won't accept it
A AND B	Spaces in it
A,B, & C	Commas in it
.PGM	Filename missing
ANDTHISONEISTOO.LONG	

These names are okay for DOS:

()<<>>().XXX
#1#2#A3B
@@.---
Z

but can you guess what is in any of these files?

A *good* name for a file will help you remember what kind of information is in the file, and perhaps whether it's a file that contains a program or only data. For example, **ADDRLIST.BAS** is a good name for a BASIC program file that prints an address list.

File Specifications

The other thing that DOS needs to know to find information is “Where”—that is, which drive contains the diskette that has a particular file on it.

The *drive specifier* is a letter and a colon, like A:, and it tells where the file is. You always need to type the colon after the drive specifier letter.

The filename and extension immediately follow the drive specifier, like this:

A:81PRICES.JUL

Don't put any spaces between the three parts. These three parts together—the drive specifier, the filename, and the extension—are called a *file specification*.

Sometimes you don't have to type the drive specifier; whenever the drive specifier is the same as the default drive, you don't have to type it.

For example, assume A: is the default drive (remember you can tell by looking at the prompt—A> in this case). Then you could type

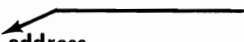
a:address OR address  Look—no drive specifier!

They are exactly the same to DOS when A: is the default drive.

Here are some more file specifications:

A:81PRICES.AUG

A:KIKI.J

B:BOWL.BAS

B:MINE

YOURS  With this kind of file specification, DOS assumes that the file (YOURS) can be found on the default drive.

Global Filename Characters

Sometimes you will want to do the same thing with several files—for example, copying a group of files at one time, or listing the names of a group of files that are somehow related.

Two special *global filename characters* let you indicate a number of files with one specification. These characters are the question mark (?) and the asterisk (*). They are used in a filename and/or an extension to mean “any character.”

These characters can save you a lot of typing if your files are named appropriately. Let’s look at some examples to tell you about global filename characters.

In the examples that follow, you need to know that the DOS command *DIR* displays information about files that match the file specification you type.

The ? Character

A ? in a filename or extension means that *any* character can be in that position. So, all files that have a name that matches in all except the ? positions are selected.

For example, suppose the diskette in drive A: has these files on it:

79PRICES.AVG
80PRICES.AVG
81PRICES.JAN
81PRICES.JUL
81PRICES.AUG
79INVTRY

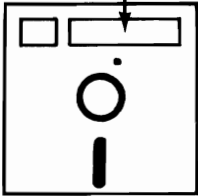

If you type:

```
dir ??prices.???
```

all the files except the last one (79INVTRY) are listed on the screen.

DOS

These are the files that match and are listed:

79PRICES.AVG
80PRICES.AVG
81PRICES.JAN
81PRICES.JUL
81PRICES.AUG

For another example, suppose you give DOS this command:

dir ??prices.a?g

Then these files match and are listed:

79PRICES.AVG
80PRICES.AVG
81PRICES.AUG

The * Character

A ***** in a filename means that any character can be in that position and in the rest of the filename. Likewise, a ***** in an extension means that any character can be in that position and in rest of the extension. Using an asterisk is like typing several **?**'s, but shorter. Unlike **?**, two or more ***** are never used together. One is enough!

Assume that the same diskette we saw with “The ? Character” is in drive A:.

If you give DOS this command:

dir 81*.j*

then these files are selected and displayed:

81PRICES.JAN
81PRICES.JUL

For another example, perhaps we tried this:

```
dir 8*.*
```

These files would be listed:

```
80PRICES.AVG  
81PRICES.JAN  
81PRICES.JUL  
81PRICES.AUG
```

And if you type:

```
dir *.*
```

all the files would be listed.

You can use both global filename characters together. For example, if you type:

```
dir ??p*.a*
```

you would see these files listed:

```
79PRICES.AVG  
80PRICES.AVG  
81PRICES.AUG
```

Global characters are fun, but you need to be careful both in naming your files and in using them—you may get results you didn't expect!

For You to Try

Insert your DOS Diskette in drive A: and type this:

```
dir *.com
```

and press the Enter key.

Now try this:

```
dir ????????.com
```

and press the Enter key.

Type this:

```
dir c*.com
```

and press the Enter key. Did you see three files listed?

An Exercise: Listing the DOS Diskette Files

Here's something for you to do right now—use the DIR command to find out the names of the files on the DOS Diskette.

This exercise also teaches you how to print a directory listing. If you don't have a printer, do the parts you can, and read along for the rest.

Before You Begin

Find your DOS Diskette, and make sure that your printer is on, is on-line, and has paper in it.

Let's Go

- 1 Make sure DOS is ready and **A>** is displayed.
- 2 Press and hold the Ctrl key, and then press the Prtsc key.

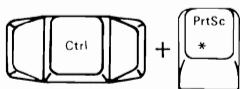

This will cause the printer to print everything that appears on the screen.

- 3 Insert your DOS Diskette into drive A:.
- 4 Type this:

dir

and then press the Enter key.

- 5 When the directory of your DOS Diskette has been completely displayed and printed, tear off the listing and look for these files:

ART	.BAS	SAMPLES	.BAS	MORTGAGE	.BAS
COLORBAR	.BAS	BUG	.BAS	CALENDAR	.BAS
MUSIC	.BAS	DONKEY	.BAS	BLUE	.BAS
HUMOR	.BAS	POP	.BAS	FORTY	.BAS
DANDY	.BAS	MARCH	.BAS	STARS	.BAS
HAT	.BAS	SCALES	.BAS	SAKURA	.BAS
CIRCLE	.BAS	PIECHART	.BAS	BALL	.BAS
		COMM	.BAS	SPACE	.BAS

They are the names of the sample program files. You can learn how to run these programs in “*USING BASIC—Running the SAMPLES Program*” in the next chapter of this section.

- 6 Now hold down the Ctrl key and press the Prtsc key. This stops the printer from printing what is displayed.

DOS Diskette Files

Here is a list of the files that are on the DOS Diskette. This list may not be in the same order as your directory list and of course you don't see two columns of names.

COMMAND	.COM	DANDY	.BAS
CHKDSK	.COM	HAT	.BAS
SYS	.COM	SAMPLES	.BAS
FORMAT	.COM	BUG	.BAS
TIME	.COM	DONKEY	.BAS
DATE	.COM	POP	.BAS
DEBUG	.COM	MARCH	.BAS
EDLIN	.COM	SCALES	.BAS
DISKCOMP	.COM	MORTGAGE	.BAS
DISKCOPY	.COM	CALENDAR	.BAS
MODE	.COM	BLUE	.BAS
COMP	.COM	FORTY	.BAS
LINK	.EXE	STARS	.BAS
BASIC	.COM	SAKURA	.BAS
BASICA	.COM	CIRCLE	.BAS
ART	.BAS	PIECHART	.BAS
COLORBAR	.BAS	BALL	.BAS
MUSIC	.BAS	COMM	.BAS
HUMOR	.BAS	SPACE	.BAS

There are two more files on your DOS Diskette but they won't show up in a directory listing. They are:

IBMBIO .COM
IBMDOS .COM

and they are important because they're the "heart" of DOS. They take up two of the 64 directory entries that a diskette can have.

Things You Can Do with DOS

The rest of this chapter steps you through procedures that do some everyday tasks. Read it now to get familiar with these commands and then you can use it to refer to when you really have to do that task.

Just remember, you will have to *substitute the names of your own files* for those we have used here—it's that easy.

Summary of Commands

These are some of the DOS commands. In this section we discuss the ones marked with an asterisk (*).

Command	Function
CHKDSK	Check DiSK makes sure the specified diskette's files and directory match and gives you a status report about the diskette and memory.
* DISKCOMP	DISKette COMPare compares the contents of two diskettes and tells you if they don't match.
* COPY	COPY copies the file(s) you specify to the same or another diskette.
DATE	DATE lets you store a date in the computer.
* DIR	DIRectory displays a list of all the files with names that match the name you specify.
* DISKCOPY	DISK COPY puts a copy of an entire diskette on another diskette. It runs somewhat faster than copy when backing up an entire diskette.
ERASE	ERASE deletes (gets rid of) the file(s) you indicate.

Command	Function
COMP	COMPare compares the contents of two files against each other and tells you if there are differences.
* FORMAT	FORMAT gets a new diskette ready to be used and optionally copies DOS to it.
* MODE	MODE lets you change the amount of information displayed on the screen or printed on the printer. It also lets you shift the information on the screen over to the right a few positions.
* RENAME	RENAME lets you change the name of a file.
SYS	SYSTEM transfers a copy of DOS to another diskette.
TIME	TIME lets you set a clock in the computer.
* TYPE	TYPE displays the contents of a file on the screen.

Once you have gotten acquainted with the DOS commands in this chapter, go to the *Disk Operating System* book for more information on all the commands.

Resident Commands

Most of the commands are actually programs that are on the DOS Diskette. However, a few of the more frequently used commands are *resident*, that is, they are always in computer memory and available as you need them. This means that *for them* you do *not* need to first insert the DOS Diskette. They are:

COPY
DIR
ERASE
RENAME
TYPE

Giving DOS a Command

To give DOS a command:

1. Wait until you see the DOS prompt, **A>**.
2. Type the command and any other parts the command requires (for example, a drive specifier or a file specification).

You can type in upper or lower case (or a combination). Use a blank (the spacebar) to separate the parts of the command from each other.

3. Press the Enter key when you have finished typing.

FORMAT—Getting a Diskette Ready to Be Used

The FORMAT command gets a diskette ready to receive information. FORMAT checks the diskette for bad spots, builds a directory to hold information about the files that will eventually be written on it, and optionally, copies the DOS system files onto the diskette.

Sometimes the terms “initializing” and “preparing” are used instead of “formatting.”

You *must* use FORMAT before you try to use a *new* diskette.

You can use FORMAT if a diskette has developed defective areas. FORMAT makes sure these areas are not used for your files. CHKDSK will tell you if there are defective areas on your diskette.

You can also use FORMAT as a way to prepare a diskette that has information you *no longer need* for use again.

DO NOT use FORMAT each and every time you want to put information on a diskette, because FORMAT wipes off what was there already.

To sum up, you need to use FORMAT once per diskette, when it is new. Very occasionally you will re-FORMAT a diskette if it has defective areas or if you want to forget what was on it and use it as if it were new.

Before You Begin

Have on hand your DOS Diskette, and the diskette you want to format.

Also decide whether you want a copy of DOS on your new diskette. Sometimes you will want DOS on a diskette if you will be putting major programs on it. On the other hand, if the diskette is going to be used for data files, you will probably not want DOS on the diskette.

If You Want DOS on Your Diskette

With One Drive

- 1 Make sure DOS is ready and **A>** is displayed.
- 2 Insert your DOS Diskette into drive A:, if it is not already there.
- 3 Type:

`format a:/s`

and press the Enter key.
- 4 Now you will see this message:

**Insert new diskette for drive A:
and strike any key when ready**

- 5 When the drive A: “in use” light is off, remove the DOS Diskette from drive A:.
- 6 Put your new diskette into drive A:.
- 7 Press any key—the space bar for instance.
- 8 You will see this message:

Formatting . . .

- 9 After some whirring and clicking, you will see this:

```
Formatting. . .Format complete
System transferred

Format another (Y/N)?
```

- 10 Type:

n

You don't have to press the Enter key.

- 11 Now you will see the DOS prompt, **A>**, and you can remove your newly formatted diskette.

The diskette is now ready to be used. It has a copy of the DOS system on it (that's because in step 3 you typed /s—the “s” stands for “system”).

If You Do Not Want DOS on Your Diskette

If you don't want DOS on your diskette, in step 3 you can type instead:

format a:

and press the Enter key. Then the line that says “System transferred” (step 9) does not appear.

Formatting Several Diskettes

If you want to format several diskettes in a row, follow steps 1 through 9. But do this at step 10.

10 Type:

y

(You probably already guessed.)

You will again see the message at step 4. Follow the same steps for each diskette you want to format at this time.

With Two Drives

If you have two diskette drives, insert your DOS Diskette into drive A: and put your new diskette into drive B:.

Then, for step 3, type:

format b:/s

or **format b:**

depending on whether you want the DOS system on your diskette.

In step 4, the message is now going to be:

**Insert new diskette for drive B:
and strike any key when ready**

The rest of the steps are the same except you will *not* have to remove the DOS Diskette.

DIR—Finding Out What Is on a Diskette

It is often handy to find out what files are on a diskette—perhaps because you need to find out how a particular filename is spelled, or because you can't recall what's on a seldom-used diskette.

The Directory command (DIR) displays a list of all the files that match a name you specify. You've seen this command before in the section "Global Filename Characters." Let's see how you might use it.

Before You Begin

All you need for DIR is the diskette for which you want to see the directory.

To List All the Files

With One Drive

- 1 Make sure DOS is ready and **A>** is displayed.
- 2 Remove the DOS Diskette from drive A:, if it is there.
- 3 Insert into drive A: the diskette whose directory you want to list.
- 4 Type:

 dir

and press the Enter key.
- 5 Watch the screen.

The screen displays the *filename*, the *extension*, the *size* of the file (in bytes), and the *date* that information was last written in the file. One line is displayed for each file on the diskette.

Remember, if the information is moving too fast for you to read it, press and hold the Ctrl key and then press the Num Lock key. Then press another key when you're done reading to start displaying again. It is also a good idea to print a copy of a diskette's directory (Ctrl + Prtsc) to keep with the diskette.

- 6 When all the files have been installed, the DOS prompt appears: **A>**

With Two Drives

If you have two diskette drives, you can keep the DOS Diskette in drive A:, if it is there, and insert your diskette into drive B:. Then at step 4, type this:

```
dir b:
```

and press the Enter key.

You have to tell DOS where to find the diskette—in this case the one in drive B:. Otherwise, DOS assumes you mean the default drive diskette if you type only the command (**dir**) without a drive specifier.

To List One File

With One Drive

For this example, let's assume that you think you have a file name FACT&FIG on a diskette. Here's how you make sure:

- 1 With DOS ready (**A>** is displayed), insert the diskette into drive A:.
- 2 Type:

dir fact&fig

and press the Enter key.

- 3 If FACT&FIG is indeed on the diskette, its filename (FACT&FIG), its extension (in this case, blanks), its size, and its update date are shown.

If the diskette does not have a file named FACT&FIG, then after a second or two the message:

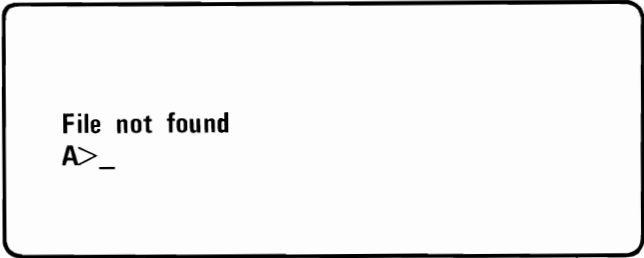

```
File not found
A>_
```

is displayed.

With Two Drives

You can insert the diskette with the file into drive B: and type this for step 2:

```
dir b:fact&fig
```

Now press the Enter key.

See, the only difference is that you have to tell DOS where (what drive) the file is.

For You to Try

Use DIR to list the directory information about the file called CIRCLE.BAS on your DOS Diskette. Did it work right?

Try it again leaving off the extension (.BAS). See the difference?

DISKCOPY—Backing Up a Diskette

Backing up a diskette means to make a copy of the diskette's data on another diskette. Similarly, *backing up a file* means to make a copy of the file (usually on a different diskette). (Backing up one file is discussed in the next part of this chapter.)

A *backup*, that is, the copy, saves you the time, trouble, and, sometimes, the expense of recovering the information on a diskette that has been lost, damaged, or accidentally written over. A backup often saves your temper, too.

It is a good habit to back up your *important program* diskettes as soon as you purchase or create them. Then, store your original diskettes properly in a place where you can find them if you need to. And then use the back-up diskettes for everyday operations.

Note: Some purchased program diskettes cannot be copied. In these cases, the documentation that comes with the programs will explain the best methods of backing them up.

Your *data diskettes* should be backed up every time you add or change information on them.

Before You Begin

You will need these diskettes:

- The diskette you want to back up—we're going to call this your "original" diskette. You may also see it called the "source" diskette or the "from" diskette.
- The diskette that will become the "back-up" diskette. If this is a new diskette, as it probably should be, make sure the diskette has been formatted first. Other names for this diskette are the "target" diskette, "destination" diskette, and the "to" diskette.

Protecting Your Original Diskette

Hint: It's a good idea to *put a tab* over the write protect notch in order to make sure your original diskette is not accidentally written on. Then you can remove it when the back-up has been made, if you want to.

With the write protect notch covered, if the diskettes get mixed up, a message similar to this is displayed:

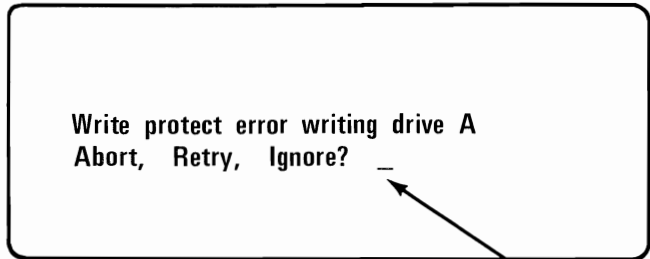

The cursor is here.

If you get this message:

- 1** Remove the original diskette from the drive.
- 2** Insert the back-up diskette into the drive.
- 3** Type:

r

(You do *not* have to press the Enter key.)

Backing Up with One Drive

If you have only one diskette drive, you must remove the original diskette and insert the back-up diskette. You will have to make this switch (“swap”) four or more times. How many times you must exchange diskettes depends on whether you’re using DISKCOPY or COPY, on how large files being copied are, and on how much memory your computer has.

DOS will tell you when you must exchange diskettes. DISKCOPY will give you these messages:

Insert source diskette in drive A

Insert target diskette in drive A

So you should:

Insert	When
Original diskette	“source” message is displayed
Back-up diskette	“target” message is displayed

- 1** Make sure DOS is ready and **A>** is displayed.
- 2** Insert the DOS Diskette into the drive, if it is not already there.
- 3** Type this:
diskcopy
and press the Enter key.

- 4** This message appears:

Insert source diskette in drive A
Strike any key when ready

BEFORE YOU PRESS A KEY:

- 4A** Remove the diskette that is in the drive.
4B Insert your *original* diskette into the drive.
4C *Now* press a key.
- 5** You will see the “in use” light come on while the original diskette is being read, and then this is displayed:

Insert target diskette in drive A
Strike any key when ready

BEFORE TOUCHING A KEY:

- 5A** Remove your original diskette.
5B Insert the back-up diskette.
5C *Now* press a key to tell DOS the correct diskette has been inserted.

- 6 You will see the “in use” light come on while the back-up diskette is being written.

Then the message shown in step 4 will appear again.

Hint: For this procedure, you can remember which diskette to insert, if you remember “Original = Source”. Insert your original diskette when DISKCOPY asks for the source diskette.

- 7 Keep repeating steps 4 and 5 until this message appears:

Copy complete

Copy another? (Y/N)

- 8 Type this:

n

You don't have to press the Enter key.

- 9 The DOS prompt, **A>**, is displayed.

Remove the back-up diskette from the drive. With a felt-tip pen, mark the label with the contents, the date, and perhaps the word “Back-up.”

Backing Up with Two Drives

- 1 Make sure DOS is ready and **A>** is displayed.
- 2 Insert your DOS Diskette into drive A:.
- 3 Type this:

diskcopy a: b:

and press the Enter key.

- 4 You will see this message:

Insert source diskette in drive A
Insert target diskette in drive B
Strike any key when ready

- 5 Remove your DOS Diskette from drive A:
6 Insert your original diskette into drive A:
7 Insert your back-up diskette into drive B:.

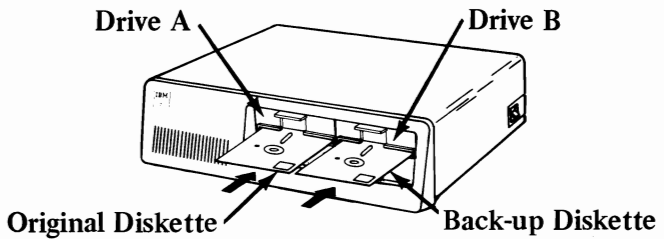

- 8 Press a key.
This tells DOS you are ready.
9 Now all information is being copied from the diskette in drive A: to the diskette in drive B:.

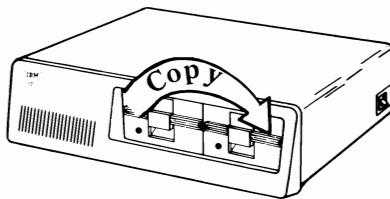

You will see one "in use" light go on and then the other.

- 10** When the copy has been made, you will see a message similar to this:

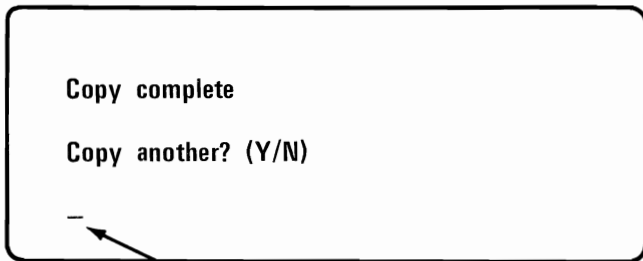

The cursor is here.

- 11** Type:

n

and press the Enter key. The DOS prompt, A>, is displayed.

- 12** Remove both diskettes.

Use a felt tip pen to label and date the back up diskette. You may also want to write "Back-up" on the label to remind yourself that this is a copy of another diskette.

COPY—Backing Up One File

Sometimes you will find it useful to copy only *one* file. You might want to copy one file instead of a whole diskette when:

- Only one file of a whole diskette has been changed and needs to be backed up.
- You want to make extensive changes to a file or when you're not too sure of the effect of the changes. It is safer to change a copy of the file rather than the original.
- You want to build a new file based on the contents of an "old" file—similar to copying a letter and then marking up the copy to make a new letter.
- You need two copies of a file. For example, if you want to give a program you wrote to a friend, you'd probably want to give a copy of the program and not your original program.

Let's use some diagrams to illustrate the various possibilities with COPY.

Assume that two of the files on the original diskette are LJCORS and DIARY, and that the file to be copied is LJCORS.

- The file (LJCORS) is copied to another diskette and the name is the same on both diskettes:

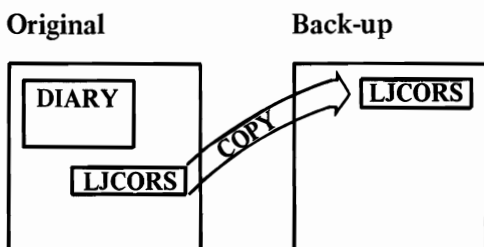

- The file (LJCORS) is copied to another diskette and the name of the copy is changed:

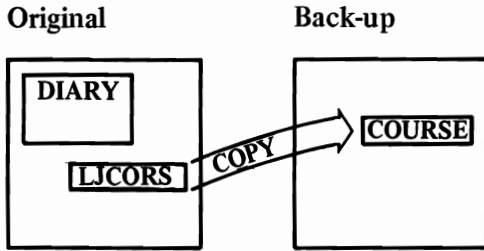

- The file (LJCORS) is copied onto the original diskette with a changed name:

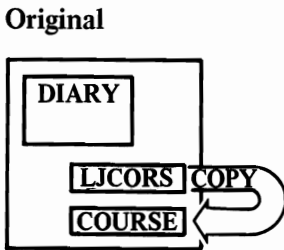

- The file (LJCORS) is copied onto the original diskette with a name that is already being used:

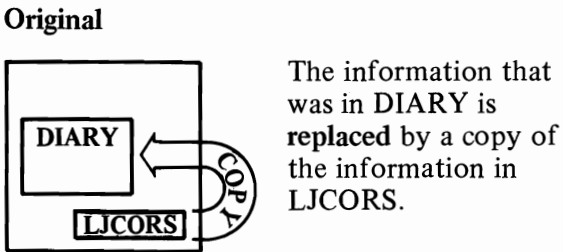

Before You Begin

Decide which kind of copy you want to make. Then collect:

- The diskette that contains the file you want to copy. We'll call this the "original" diskette.
- The diskette that will contain the copy of the file when you are done.

This may be the same diskette as your original diskette. Or it may be a different diskette, in which case we will call it your "back-up" diskette.

Also decide on the name for the copied file.

Copying a File to the Same Diskette

For this example, let's assume that LETTER is the name of the file you want to copy, and that the copy's name will be MEMO.

Recall that you need a different name because every name on a diskette must be unique. You might want to check that the name you have chosen isn't already being used, unless you really mean to **replace** that file. For this example, check by typing: `dir memo`.

Let's do it:

- 1** Make sure DOS is ready and `A>` is displayed.
- 2** Insert the original diskette (the diskette with LETTER on it) into drive A:.
- 3** Type this:

```
copy letter memo
```

and press Enter.

Notice that in the command, you type the original filename first and the back-up filename second. Separate the filenames with a space.

- 4 After a bit (depending on how long the file LETTER is), you will see this on the screen:

```
      1 File(s) copied
A>
```

- 5 LETTER has been copied and the copy has been given the filename MEMO.

You can use the DIR command to check, by typing this:

```
dir memo
```

Now press the Enter key.

- 6 Remove the diskette and put it away in its envelope because we are through with this example.

Copying a File to Another Diskette Using One Drive

Remember, with only one diskette drive, you will need to exchange diskettes while COPY is running. DOS will tell you when the change must be made by showing you a message.

COPY's messages sound as if you had two drives instead of one. You should think of the messages as referring to *diskettes* instead of drives.

For our examples, think of your original diskette as the "*drive A.*" diskette. Think of the back-up diskette as the "*drive B.*" diskette. (Even though you have no drive B:, the command is the same for one drive or two. The computer keeps track of the real drive A: and the "imaginary" drive B:.)

If you had two drives

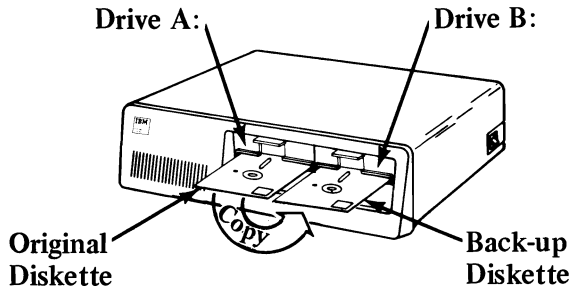

But with one drive

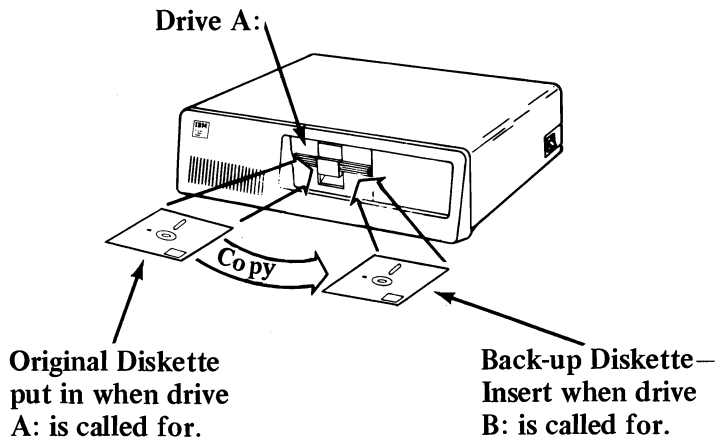

So you should:

Insert	When
Original diskette	“drive A:” message appears
Back-up diskette	“drive B:” message appears

Let's assume that the file you want to copy is LETTER. For this example, we are going to copy LETTER to another diskette without changing its name.

- 1 Make sure DOS is ready and **A>** is displayed.
- 2 Insert the diskette with **LETTER** on it (the *original* diskette) into your drive.

- 3 Type this:

copy letter b:

and press the Enter key.

Notice again where the spaces are.

- 4 This message is displayed:

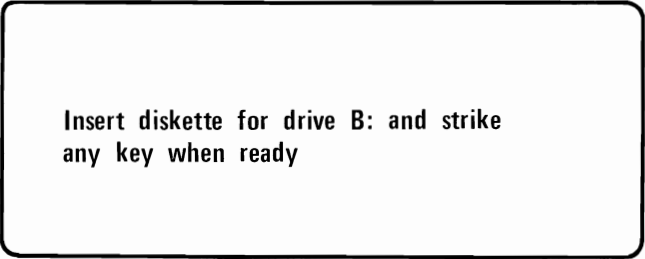

**Insert diskette for drive B: and strike
any key when ready**

- 5 Remove the original diskette. (But don't put it away—you may need it soon.)
- 6 Insert the back-up diskette into drive.
- 7 Now press a key to tell DOS that the diskettes have been switched.
- 8 Depending on the size of the file being copied (**LETTER**, in this example) and your computer's memory, you may see this message:

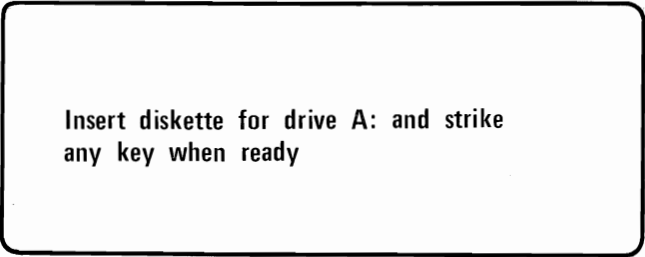

**Insert diskette for drive A: and strike
any key when ready**

If you do see the message, do this:

- 8A** Remove the back-up diskette from the drive.
- 8B** Insert the original diskette into the drive.
- 8C** Press a key.
- 8D** Now go back to step 4.

Hint: It's easier to remember which diskette to insert if you think "**B**: is for **back-up**". Insert the back-up diskette when the drive B: message appears.

- 9** When the copy has been made, this message is displayed:

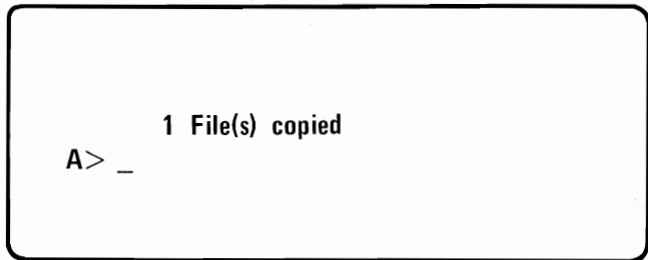

- 10** Remove the back-up diskette from the drive and label it with a felt-tip pen.
- 11** Now you can put both diskettes away—LETTER has been copied to the second diskette.

For You to Try

Select a file on your DOS Diskette to copy to another diskette—how about DONKEY.BAS? Keep the name the same (unless the diskette you'll put the copy on already has a file called DONKEY.BAS).

Copying a File to Another Diskette Using Two Drives

Let's assume you want to copy LETTER (again!). But this time, you want to put the copy on another diskette.

What name do you want it to have? For this example, we have picked the filename CORESPND for you. Here are the steps:

- 1 Make sure DOS is ready and A> is displayed.
- 2 Insert the diskette with LETTER on it into drive A:.
- 3 Insert the diskette that you want the copy (CORESPND) to be written on, into drive B:.

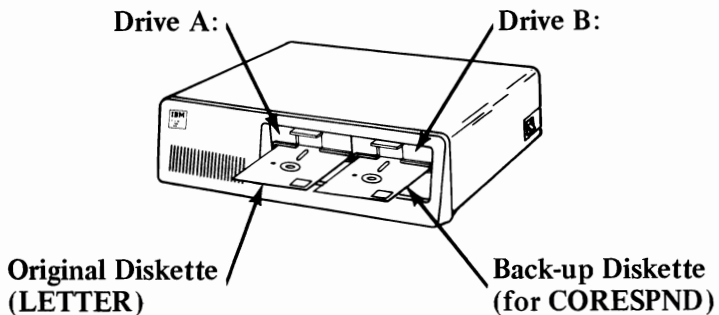

- 4 Type this:

```
copy letter b:corespnd
```

and press the Enter key.

Notice the spaces between “copy” and “letter” and between “letter” and “b:corespnd”. *Do not* put a space between “b:” and “corespnd”.

Also notice that you must indicate the diskette drive (b:) of the copy diskette because it is not the same as the default drive. (Look back at “The DOS Prompt” for information about the default drive.)

- 5** One “in use” light will come on and then the other.

When the copy has been made, this is displayed:

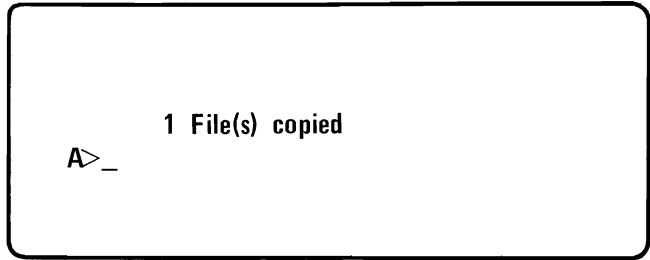

- 6** You can now remove both diskettes and use a felt-tip pen to label the back-up diskette.

Now you can put both diskettes away—LETTER has been copied to the second diskette (and has been retired from use in all future examples).

If you want the copied file to have the “same old name” on the other diskette, this is what you’d type in step 4:

copy letter b:

or

copy letter b:letter

For You to Try

Practice this exercise by copying the file BLUE.BAS to another diskette. Change the name, if you wish. Remember, the back-up diskette needs to have been formatted, if it’s brand new.

TYPE—Displaying What Is in a File

The TYPE command lets you “look into” a file; that is, it displays the contents of a file on the screen.

As the example will show, you can also print the contents if you have a printer.

Before You Begin

Locate the diskette that has the file you want to display. You also need to know the exact name of the file (use DIR again).

Here's How You Do It

For this example, assume that the file you want to display is ITEMS.DAT.

- 1** Make sure DOS is ready for a command; **A>** is displayed.
- 2** Insert the diskette with ITEMS.DAT into drive A:.
- 3** If you have a printer:
 - 3A** Make sure that the printer is turned on, is on-line, and has paper in it.

- 3B** Press and hold the Ctrl key and then press the Prtsc key.

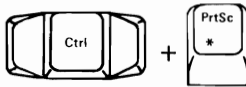

- 3C** Release both keys.
- 3D** Check to see that “echo to the printer” has been turned on by pressing the Enter key.
- 3E** Both the screen and the printer should show the prompt, **A>**.
- 3F** If the printer didn't print **A>**, do steps 3B through 3E again.

4 Now type:

```
type items.dat
```

and press the Enter key.

5 The command you just typed and contents of ITEMS.DAT will be displayed and printed.

6 When you see the DOS prompt, **A>**, you can remove the diskette and put it away.

7 Stop the printer from printing what is displayed on the screen by pressing and holding the Ctrl key and then pressing the Prtsc key.

Some files contain information that you won't be able to read. These are programs or certain data files that the computer can read—but we can't. The printer information might look similar to this:

```
T+
S
. . . . .
T_a>] u \<t>8 u(>7u 7<t>j
u 8}
! \u ^>7u 7 \7}
```

And the information on the screen looks even stranger!

RENAME—Changing a File’s Name

The RENAME command lets you change a file’s name—either its filename, its extension, or both.

This may be useful if you’ve found that you simply cannot type a name the way you’ve spelled it. More often, the reason for changing is that you just want to refer to a file with a different name.

Before You Begin

Have on hand the diskette with the file that you want to rename. You also need to know its exact “old” filename and extension, if it has one. (Remember, you can use the DIR command to find out the filename.)

With One Drive

For this example, let’s assume that a diskette has a file named STOCKS.DAT on it, but that we have decided that ASSETS.80 is a more descriptive name for this information. Also assume that we have checked this diskette’s directory and found out that there is *not* already a file named ASSETS.80 on it.

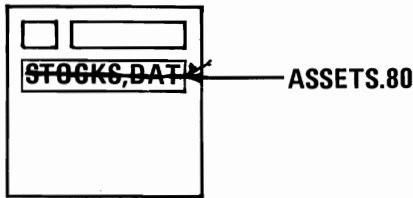

Here's how to change the name:

- 1** Make sure DOS is ready and **A>** is displayed.
- 2** Insert the diskette with **STOCKS.DAT** on it into drive **A:**.
- 3** Type this:

```
rename stocks.dat assets.80
```

Check your typing, and then press Enter.

Notice that the “old” name is first, then a space, and then the “new” name.

- 4** In a moment, DOS displays the prompt, **A>**, and the file has been renamed.
- 5** You can check to see that the file has really been renamed by typing:

```
dir stocks.dat
```

This should be displayed:

```
File not found  
A>_
```

Then type:

```
dir assets.80
```

Now the information about that file should be displayed.

6 Remove your diskette and put it back in its envelope.

Be careful about using global filename characters in the “old” file specification. You may get *unexpected* results. Changing back to the names you want may be more tedious than renaming the files one by one in the first place.

With Two Drives

If you have two diskette drives and already have another diskette in drive A:, then insert the diskette with STOCKS.DAT on it into drive B:. For step 3, type this:

```
rename  stocks.dat b:assets.80
```

Of course you must type b: with the dir commands in step 5 also, thus:

```
dir  b:stocks.dat
```

and

```
dir  b:assets.80
```

For You to Try

Try using the RENAME command on one of the files that you copied (in a previous “practice” exercise).

ERASE—Removing a File from a Diskette

One of the “housekeeping” chores associated with diskettes is to remove files that you no longer need from diskettes. The ERASE command does this for you.

Removing old files makes room for new information on a diskette. It can eliminate a potential source of confusion too—you are less likely to use an old version of a program or an old data file for processing.

But *plan ahead* and *check your typing* when you use ERASE.

After a file is erased, the data is gone. Unless you have made a backup, the only way to re-create a file that has been erased is by repeating the steps that you took to create it in the first place.

Before You Begin

You need the diskette with the file that you want to erase. Again, you need to know the exact filename and extension of that file (use DIR if you need to).

And make sure you really will *not* need this file.

With One Drive

For this example, assume that the file to be removed is ASSETS.80 (the one we just used in the RENAME example).

- 1 Make sure DOS is ready with **A>** displayed.
- 2 Insert the diskette with the file you no longer need into drive A:.
- 3 Type this:

```
erase assets.80
```

and check your typing. Now press Enter.

- 4 In a moment, DOS shows you the prompt, **A>**. The **ASSETS.80** file has been removed from the diskette.
- 5 To assure that the file has been erased, try the **DIR** command again, like this:

```
dir assets.80
```

and press Enter.

The message **File not found on the DOS prompt, A>**, should appear.

- 6 Remove the diskette and put it back into its envelope.

With Two Drives

If you can use drive **B:**, insert the diskette into drive **B:** and type this for step 3:

```
erase b:assets.80
```

and this for step 5:

```
dir b:assets.80
```

Again, the only difference is that you have to remember to type the drive specifier (**b:**) because it is not the default drive.

Global Filename Characters

BE CAREFUL WITH GLOBAL FILENAME CHARACTERS.

We recommend that you **DO NOT USE** global filename characters in the file specification of the ERASE command until you are familiar with **exactly** what they will do.

For example, typing

```
erase *.*
```

removes *all* the files from the diskettes (except the DOS system files, if present).

If the files that are removed by using global characters are not the ones that you expected, you can recover this information only if you have previously made a back-up diskette.

MODE—Shifting the Display on the Screen

You may find that the first two or three characters on a line of the display do not show up on the screen. If your display device does not have a horizontal adjustment control, you can use the DOS MODE command to shift the displayed lines to the right.

Before You Begin

You need only your DOS Diskette to do this.

Shift Right

- 1 Make sure that DOS is ready and **A>** is displayed (although you probably can't see it).
- 2 Type this:

```
mode ,r,t
```

Check your typing—did you put the space and then the comma before the “r”?

When it's okay, press the Enter key.

- 3 Now a test pattern will appear on your screen.

4 If your screen looks okay, type this:

y

and press the Enter key.

If you want your screen moved over to the right a little more still, type this:

n

and press the Enter key.

Note: We've also given you a way to shift the display over using the BASIC OUT command. See the "Using BASIC" chapter in this section.

The *Disk Operating System* book describes more uses of the MODE command.

Helps and Hints

We are ending this chapter with a few hints—maybe they will save you some trouble or help you as you use your IBM Personal Computer.

- Make backups regularly.

(We have repeated this already, but since this is our last chance, we are saying it one more time.)

- Sometimes, commands do not work as you expected because a file specification was typed incorrectly.
 - Check your typing.
 - Do you have the correct diskette in the drive?
 - Check the directory of the diskette.
 - Has the correct diskette drive been specified or is it being assumed? Has the colon been included?
 - Has the filename been spelled correctly?
 - Have you forgotten to use the extension?
(In the case of BASIC program files, for example, it is easy to forget the .BAS that BASIC uses for an extension.)
- If a command still doesn't work, read the book again.
- Be careful with global filename characters, especially in the ERASE command. If you insist on using them:
 - Use the DIR command first with the global filename specification, to test the results.
 - Check to see that these are **really** the files you want to delete.
 - Then, go ahead.
- Print a directory frequently (if you have a printer) and store the listing with the diskette. The labels are usually too small to hold everything you want to write on them.

- The date shown with each directory entry is the date of the last addition or change to that file. The date is not changed during a COPY or a DISKCOPY.

At first glance,

```
diskcopy a: b:  
and copy a:*. * b:
```

may appear to have the same purpose—copying an entire diskette. They do, only when copying to a diskette with no files on it.

With COPY, if files already exist on the back-up diskette, they will either be replaced (if files being copied have the same name) or left alone. This is because COPY goes through the original diskette, copying each file, one at a time. COPY does not disturb old files on the back-up diskette as long as their names aren't the same as files being copied.

DISKCOPY, however, makes a “carbon copy” of the original diskette, wiping out all old files on the back-up diskette during the COPY process.

Summary

We've covered a lot in this chapter. We have told you about:

- Starting DOS and telling it the date
- Keys that have special uses in DOS
- Making a back-up copy of your DOS Diskette
- Diskettes and terms that are used with them
- Files and their names
- Finding out what files are on the DOS Diskette.

We have provided step-by-step procedures for using these DOS commands:

- FORMAT
- DIR
- DISKCOPY
- COPY
- TYPE
- RENAME
- ERASE
- MODE

We hope you're well on your way to feeling comfortable with your computer and DOS. No matter how much we've covered, there's always more—in particular, we haven't given you the short-cuts that you'll start to pick up as you read the *Disk Operating System* book and use the commands.

Now it's time to read the next chapter, "Using BASIC" to learn about running BASIC programs.

Using BASIC

Contents

Introduction	BASIC 3-3
Starting BASIC	BASIC 3-4
For Cassette BASIC	BASIC 3-4
If Your Computer Is Off	BASIC 3-4
If Your Computer Is On	BASIC 3-4
For Disk BASIC	BASIC 3-5
For Advanced BASIC	BASIC 3-5
The BASIC Start-up Screen	BASIC 3-6
The BASIC Prompt	BASIC 3-6
Shifting the Display on the Screen	BASIC 3-7
Returning to DOS	BASIC 3-7
Several BASIC Commands	BASIC 3-8
Some Keys You Will Use With BASIC	BASIC 3-8
Function Keys	BASIC 3-8
Running a BASIC Program	BASIC 3-9
Running the SAMPLES Program	BASIC 3-9
For Choices A, B, C, H and I	BASIC 3-11
For Choices D, E, F, G, and J (and the others too)	BASIC 3-11
Running the COMM Program	BASIC 3-13
COMM Program Choices	BASIC 3-15
Running a BASIC Program on Another Diskette	BASIC 3-16
With One Diskette Drive	BASIC 3-16
With Two Diskette Drives	BASIC 3-17
If You've Forgotten the File's Name	BASIC 3-18
Entering Your Own BASIC Program	BASIC 3-20
Storing Your BASIC Program	BASIC 3-22
Changing Your BASIC Program	BASIC 3-22
Finding Out What the Statements Are	BASIC 3-23
Retyping	BASIC 3-24
The EDIT Command	BASIC 3-25
Adding a Statement	BASIC 3-26
Removing a Statement	BASIC 3-27
Summary	BASIC 3-28

Notes:



Introduction

Your IBM Personal Computer has three versions of BASIC. *Cassette BASIC* is built into your computer. *Disk BASIC* and *Advanced BASIC* come to you on your DOS Diskette.

BASIC is a programming language that is used to write programs—sets of instructions to tell your IBM Personal Computer what it should do for you.

Cassette BASIC uses a cassette recorder to hold program and data files. It cannot use diskettes.

Disk BASIC does everything *Cassette BASIC* does and in addition *can* use diskettes for files.

Advanced BASIC does everything that *Cassette BASIC* and *Disk BASIC* do, and more. It also has some commands like *CIRCLE*, *DRAW*, and *PAINT* that let you do some nifty graphics if you have the *Color/Graphics Monitor Adapter*. And it has the *PLAY* statement for making your computer play tunes.

You can find out more about the additional features of all three versions of BASIC in Chapter 1 of the *IBM Personal Computer BASIC* book.

Both *Disk BASIC* and *Advanced BASIC* run *under DOS*, which means that *DOS* must be running before *Disk BASIC* or *Advanced BASIC* (or programs written in *Disk BASIC* or *Advanced BASIC*) can be started. They use *DOS* to manage input from (reading) and output to (writing) the various devices of your computing system.

This section is meant to familiarize you with enough BASIC so that you can use the *SAMPLES* program (on your *DOS Diskette*) and can run other BASIC programs that you buy. The chapter also shows you how to enter a very small BASIC program of your own.

Starting BASIC

For Cassette BASIC

Remember, Cassette BASIC does not run under DOS or use diskettes.

If Your Computer Is Off

- 1 If your system has diskette drives, remove any diskette from drive A: and shut the drive door.
- 2 Turn on your computer.
- 3 The BASIC start-up screen is displayed.

If Your Computer Is On

- 1 If your system has diskette drives, make sure there is no diskette in drive A: and that the diskette door is shut.
- 2 Press and hold the Ctrl and Alt keys down and then press the Del key.

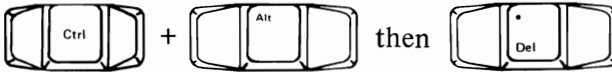

- 3 The BASIC start-up screen is displayed.

For Disk BASIC

- 1 Make sure DOS is ready and **A>** is displayed.
- 2 Insert the DOS Diskette into drive A: if it is not already there.
- 3 Type this:

`basic`

and press the Enter key.
- 4 The BASIC start-up screen is displayed.

For Advanced BASIC

- 1 Make sure DOS is ready and **A>** is displayed.
- 2 Insert the DOS Diskette into drive A: if it is not already there.
- 3 Type this:

`basica`

and press the Enter key.
- 4 The BASIC start-up screen is displayed.

You will see that the only difference between starting Disk BASIC and Advanced BASIC is the “a” at the end of the word “basic.”

The BASIC Start-up Screen

When BASIC is started, a screen similar to this is displayed:

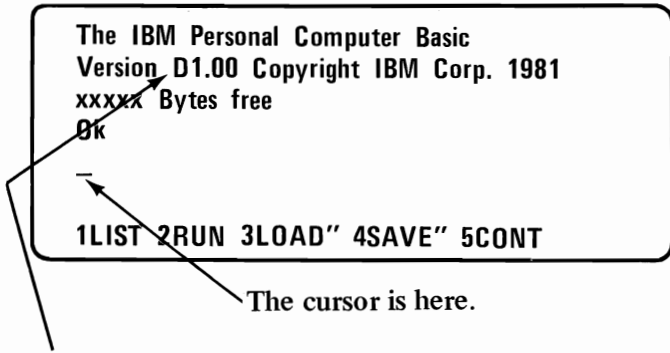

The **D** in this message tells you that **Disk BASIC** has been started. The message may instead show a **C** for **Cassette BASIC**, or an **A** for **Advanced BASIC**.

Instead of **xxxxx**, you will see some number that tells you how much room you have in the computer's memory for your programs and data.

The BASIC Prompt

Ok is BASIC's prompt. It tells you that BASIC is ready for you to tell it what to do. You need to remember to type *BASIC* commands and statements after **Ok**—you can use *DOS* commands *only* when you see **A>**; not when you see **Ok**.

Ok also tells you that the keyboard is operating in BASIC mode. Look in "Keyboard Layout and Usage" for a complete description of what the keys do.

Shifting the Display on the Screen

You may find that the first two or three characters on a line of the display do not show up on the screen. If your display device does not have a horizontal adjustment control, you can do this to shift the display, whether Cassette BASIC, Disk BASIC, or Advanced BASIC is running:

- 1 When you see BASIC's prompt, **Ok**, type this:

```
out 980,2: out 981,43
```

Check your typing, and correct if necessary. Then press the Enter key.

Note: You can also shift the display from DOS. See the section "MODE—Shifting the Display on the Screen" in the "Using DOS" chapter.

For other information about Cassette BASIC, see the *BASIC* book. The remainder of this section assumes that you are using Disk BASIC or Advanced BASIC.

Returning to DOS

Sometimes you will want to return to DOS after running a BASIC program. For example, you might want to use COPY to make a back-up copy of a file that a BASIC program created or to change from Disk BASIC to Advanced BASIC.

To return to DOS from BASIC:

- 1 Make sure BASIC is ready for a command—**Ok** is displayed.

- 2 Type this:

```
system
```

and press the Enter key.

- 3 Now you will see the DOS prompt, **A>**, and you can give DOS a command.

Several BASIC Commands

Some DOS commands have counterparts in both Disk BASIC and Advanced BASIC, so you do not always need to return to DOS.

They are:

DOS Command	BASIC/Advanced BASIC Command
DIR	FILES
ERASE	KILL
RENAME	NAME

Some Keys You Will Use With BASIC

The keys we discussed before in “Some Keys You Will Use With DOS” (except Ctrl and Prtsc) also work with BASIC.

Function Keys

You will also find the function keys (the double column of keys on the left side of the keyboard) helpful for entering some BASIC commands you use again and again. When you press a function key, a whole word or phrase is entered, saving you some typing.

Look at the bottom line of the BASIC start-up screen. It reminds you what word the function keys are associated with. For example, if you press F3, it is the same as if you typed:

load

Some of the examples that follow will illustrate how you can use these keys to save time typing.

Look in “Chapter 2. The Keyboard” and “Chapter 4. KEY Statement” in the *BASIC* book for more information about keys used with BASIC.

Running a BASIC Program

Two steps are involved with running a BASIC program that you have on a diskette.

The first step is getting a copy of the program transferred from the diskette into the computer's memory. This is called *loading* the program and is done (appropriately enough) with a LOAD command.

The second step is the actual performance of the program's instructions—*running* or *executing* the program. The command used to do this is RUN.

Let's go through this sequence looking at the SAMPLES program that is on your DOS Diskette. You can do it now.

Running the SAMPLES Program

- 1 Make sure DOS is ready and A> is displayed.
- 2 Insert the DOS Diskette into drive A: if it is not already there.
- 3 Type this:

basic

and press the Enter key.

- 4 You'll see the BASIC prompt, Ok.

Now type this:

load "samples

and press the Enter key.

(Or you can do it with the F1 function key like this:

Press: F1
Type: **samples**
Press: Enter key

Try it this way *next time*.)

5 When you see **Ok**, type this:

run

and press the Enter key.

(Or just press function key F2.)

6 Now you will see this screen. It is called a *menu* because it is like a menu at a restaurant—you select the item you want from a fixed number of choices.

SAMPLE PROGRAMS

A	– MUSIC	(32k)
B	– ART	(32k–Color/Graphics)
C	– MORTGAGE	(48k)
D	– CIRCLE	(BASICA–Color/Graphics)
E	– DONKEY	(BASICA–Color/Graphics)
F	– PIECHART	(BASICA–Color/Graphics)
G	– BALL	(BASICA–Color/Graphics)
H	– COLORBAR	(32k)
I	– CALENDAR	(32k)
J	– SPACE	(BASICA–Color/Graphics)
ESC	– EXIT	

ENTER LETTER OF PROGRAM

**NOTE: All of the above programs
require 48k if using BASICA**

Look at the remarks next to menu items. These tell you how much computer memory you need, whether you need to use Advanced BASIC (BASICA), and whether you need a Color/Graphics Monitor Adapter.

For Choices A, B, C, H and I

Try choice A—MUSIC. Just type:

a

You do not need to press the Enter key. Follow the directions that appear on the screen to hear the computer give a recital. Then follow the instructions to return to the menu.

You can select H or I now. You can also run C, if your IBM Personal Computer has 48K of memory or more. Or try B if you have the Color/Graphics Monitor Adapter.

When you have tried any or all of these programs (A, B, C, H and I), then press the Esc key.

Now you will see the BASIC prompt, **Ok**.

For Choices D, E, F, G, and J (and the others too)

In order to try choices D, E, F, G, and J, you need at least 48K of memory *and* a Color/Graphics Monitor Adapter.

Let's assume that you do and are now looking at the menu.

Do this:

- 1** Press the Esc (Escape) key.

You don't have to press the Enter key.

This returns you to Disk BASIC and you will see the BASIC prompt, **Ok**.

- 2 Make sure your DOS Diskette is still in drive A:. Then to return to DOS, type this:

system

and press the Enter key.

This gets us out of Disk BASIC and back to DOS. Now we want to start SAMPLES again using Advanced BASIC (instead of Disk BASIC).

- 3 When you see the DOS prompt, **A>**, type this:

basica

and press the Enter key.

- 4 When you see the BASIC prompt, **Ok**, type this:

load "samples

and press the Enter key.

- 5 When you see **Ok** again, type this:

run

and press the Enter key.

- 6 The SAMPLES program menu will be displayed again.

Now you can select any choice on the menu because you are now in Advanced BASIC and should have the proper computer system.

Just type the letter of your choice and have fun.

Note: If you have the Color/Graphics Monitor Adapter and sufficient memory, you can run the SAMPLES program from now on by just starting at step 3.

Running the COMM Program

A sample telecommunications program is also provided on the DOS Diskette. This program lets you establish an asynchronous communication link between your IBM Personal Computer and another IBM Personal Computer, an IBM Series/1 computer, or two communications network services.

This means that your computer can “talk” to another computer or be part of a network service. You can imagine that the computers are talking on the telephone to each other. (Using a network service is like being on a “party line.”)

The COMM program will work “as is” if you have the necessary option (Asynchronous Communications Adapter), equipment, and subscriptions. (For a description of the adapter you need, see the “Asynchronous Communications Adapter” in Section 5 of this binder.) For assistance with interfacing with external devices, consult your point of sale.

You could also use this sample program as the model for writing your own telecommunications program.

Let’s look at the COMM program menu—you can do this even if you do not plan to communicate with another computer. Do this:

1 Make sure Disk BASIC or Advanced BASIC is running and **Ok** is displayed.

2 Insert the DOS Diskette into drive A:.

3 Type this:

```
load "comm
```

and press the Enter key.

4 Type this:

```
run
```

and press the Enter key.

- 5 The sample communications program menu is now displayed:

COMMUNICATIONS MENU

Choose one of the following:

- 1 Description of program
- 2 Dow Jones/News Retrieval
- 3 IBM Personal Computer
- 4 Series/1
- 5 THE SOURCE
- 6 Other service
- 7 End program

Choice ?

- 6 You can pick option 1 or 7 now, even if you're not ready to establish communications.

You need to have the Asynchronous Communications Adapter and the proper cabling to pick any of the other choices.

Type the number of your choice. Press the Enter key.

- 7 Each choice (except 7) will show you another menu.

When you're through reading the information, press function key 1. (Function key 1 is the key in the upper left corner of the keyboard.)

Now the main menu is displayed again.

- 8 Type this:

7

and press the Enter key.

You are back to BASIC again and **Ok** is displayed.

COMM Program Choices

Here's a short description of the COMM program choices:

1 Description of program

This choice displays a screen that describes the COMM program.

2 Dow Jones/News Retrieval

This choice lets you dial in to the Dow Jones/News service.

You must have a Dow Jones/News service subscription, as well as the communications equipment, to run this choice.

3 IBM Personal Computer

This choice lets your IBM Personal Computer "talk to" another IBM Personal Computer.

You must have the Asynchronous Communications Adapter and other purchased equipment to run this choice.

4 Series/1

This choice lets your IBM Personal Computer communicate with an IBM Series/1 computer, running either Real Time Programming System V5.1 or Event Driven Executive V3.0.

5 THE SOURCE

This choice lets you connect to THE SOURCE service.

You need to get a subscription to THE SOURCE and have the adapter and purchased equipment to run this choice.

6 Other service

This choice lets you describe the kind of communication your IBM Personal Computer will set up. You do this if the choices that were made in the COMM program are not correct for your case.

Then you can start the communications session using the characteristics you've described.

7 End program

This option lets you end the COMM program and go back to BASIC. You will then see the BASIC prompt, **Ok**.

Running a BASIC Program on Another Diskette

For this example, let's assume that the BASIC program you want to run is called BOWLING and it's not on your DOS Diskette.

Let's assume too, that BOWLING is a Disk BASIC program (that is, it doesn't use the extended features of Advanced BASIC).

With One Diskette Drive

- 1 When you see the DOS prompt, **A>**, start Disk BASIC by typing:

basic

and press the Enter key.

- 2 The BASIC prompt, **Ok**, appears.

Remove your DOS Diskette from drive A:.

- 3 Insert the diskette that contains the file BOWLING into drive A:.

4 Now type:

```
load "bowling
```

and press the Enter key.

Note: If you do not supply an extension in the command, BASIC will look for a file with the extension .BAS (BAS stands for BASIC). In this case, BASIC will look for a file named BOWLING.BAS.

5 When the BASIC prompt, **Ok**, appears again, type this:

```
run
```

and press Enter.

6 Now the program BOWLING does whatever it is that it does.

With Two Diskette Drives

If you have another diskette drive, you could insert the diskette with BOWLING into the other drive.

Then in step 4, you would type:

```
load "b:bowling
```

Notice that you have to specify the drive—where the diskette with the program is.

If You've Forgotten the File's Name

Sometimes you may get a message that says:



File not found

after you've typed a command. It may be caused by spelling the filename wrong, among other reasons.

BASIC has a command, FILES, that works like the DOS DIR command. It lets you list what is on a diskette. Then you can check to see that the correct diskette is in the drive and that the name was spelled correctly. You *do not* have to return to DOS and then come back to BASIC. Following the BASIC prompt, **Ok**, just type:

files

and press the Enter key to see the name of all the files on the default drive.

If you type:

files "b:*.bas

all the files on the diskette in drive B: that have .BAS as their extension would be displayed.

This might be the results of such a command if the DOS Diskette were in drive B:.

```
Ok
files"b:*.bas
ART .BAS SAMPLES .BAS MORTGAGE.BAS
COLORBAR.BAS BUG .BAS CALENDAR.BAS
MUSIC .BAS DONKEY .BAS BLUE .BAS
HUMOR .BAS POP .BAS FORTY .BAS
DANDY .BAS MARCH .BAS STARS .BAS
HAT .BAS SCALES .BAS SAKURA .BAS
CIRCLE .BAS PIECHART.BAS BALL .BAS
SPACE .BAS COMM .BAS
Ok
```

Entering Your Own BASIC Program

A BASIC program consists of one or more BASIC statements that are preceded by line numbers. The line numbers are used by BASIC to control the sequence in which the statements are run. You use the line numbers to change, add, or delete lines within a program.

You tell BASIC that you are entering a program by beginning the line you type with a line number. After the line number comes a BASIC statement.

Unlike entering a command, the statement is *not* run when you press the Enter key. A program is not run until you type a RUN command.

Let's look at an example—a very simple program that just displays the numbers 1, 2, and 3.

1 Make sure BASIC is ready—**Ok** is displayed.

2 Type this:

```
new
```

and press the Enter key.

3 Type this:

```
10 print 1
```

and press the Enter key.

4 Type this:

```
20 print 2
```

and press Enter.

5 Type this:

```
30 print 3
```

and press Enter.

- 6 Now you are done entering this short program. Your screen should look like this:

```
Ok
new
Ok
10 print 1
20 print 2
30 print 3
_
```

The cursor is here.

- 7 To see what this program does, type:

```
run
```

and press the Enter key.

- 8 If the typing is correct, it works. Now your screen should look like this:

```
Ok
new
Ok
10 print 1
20 print 2
30 print 3
run
1
2
3
Ok
```

This example shows using line numbers that increase by 10's. This "leaves room" for inserting new statements, as you will see later. Actually you could use any line numbers as long as they were in increasing order.

Storing Your BASIC Program

Before we start making changes to this program, let's store it on a diskette. Right now, while it is the *current* program (that is, the one in memory), every time you type RUN, the program will be executed. If you want to be able to run this program after you load and run some other programs, however, you must have it *stored* on a diskette.

Let's assume we want to call this program ORIG123 (which stands for "Original 123"). Here is how you save it:

- 1 Make sure Disk BASIC or Advanced BASIC is ready—Ok is displayed.
- 2 Insert a diskette into drive A: (The diskette should have been formatted already and have space on it.)
- 3 Type this:

```
save "orig123
```

and press Enter.

- 4 The program is stored on the diskette in drive A: with the filename ORIG123 and the extension .BAS. BASIC assigns that extension because we did not specify one.

Now you can LOAD "ORIG123" and RUN it just as we showed you with the BOWLING program (see "Running a BASIC Program on Another Diskette").

Changing Your BASIC Program

To change a program, we first need to know what statements in the program are; and then, knowing that, make the changes to particular statements as necessary.

Finding Out What the Statements Are

BASIC's LIST command displays the statements in the BASIC program that is currently loaded.

Let's use our ORIG123 file to demonstrate. Assume for this example that drive A: is the default drive.

- 1 Make sure Disk BASIC or Advanced BASIC is ready—Ok is displayed.
- 2 Insert the diskette with ORIG123 on it into drive A:.
- 3 Type this:

```
load "orig123
```

and press the Enter key.

- 4 Now the program in the file ORIG123.BAS is loaded from the diskette, and then the BASIC prompt, Ok, is displayed.

- 5 Type:

```
list
```

and press the Enter key.

Program statements are listed on the screen. For our example, it should look like this:

```
Ok
load "orig123
Ok
list
10 PRINT 1
20 PRINT 2
30 PRINT 3
Ok
```

Assume that we wanted the numbers to be printed on one line, instead of on three. A semicolon (;) added to the end of both lines 10 and 20 would make the program do this.

We'll show you two different ways of making these changes—retyping and the Edit command.

Retyping

If you type a BASIC statement that has the same line number as a line in the program in memory, that line is *replaced* with the new line as soon as you press the Enter key.

For example, to change line 10, after the BASIC prompt, **Ok**, type:

10 print 1; ← Note that there's now a semicolon at the end of the line.

and press the Enter key.

Now list the program (type **list** and press Enter). Verify that the original line has been replaced by the one with the semicolon.

(If you want, you can also type **run** and see what the program does now.)

The retyping method is most useful when the statement needs a lot of changing.

The EDIT Command

The second method uses BASIC's EDIT Command.

Remember that line 20 in the program still needs a semicolon, so let's make the change like this:

- 1 After the BASIC prompt, **Ok**, type:

```
edit 20
```

and press the Enter key.

- 2 Line 20 will be shown to you like this:

```
20 PRINT 2
```

 The cursor is here.

- 3 Using the cursor right key



(on the numeric keypad),

move the cursor to the position after the second 2.
Now type the semicolon



and press the Enter key.

This method is useful when most of the statement is correct.

Editing and the use of the cursor control keys are explained in "Chapter 2. The BASIC Program Editor" in the *BASIC* manual.

Now LIST and RUN the program. Does your program look like this?

```
Ok
list
10 PRINT 1;
20 PRINT 2;
30 PRINT 3
Ok
run
  1  2  3
Ok
```

If it doesn't, use the EDIT command to make your screen match this one and run the program again.

Adding a Statement

You can add a statement to a program by typing a statement with a new line number.

For example, since our program uses only line numbers 10, 20, and 30, we could insert a statement *between* 10 and 20 by choosing any number between them—like this:

```
12 print 4;
```

We can also add lines to the end of a program by typing statements with line numbers greater than the last line number used. (The line number has to be less than 65529, however.)

In our example, we could add a line to the end like this:

```
155 print 1+4+2+3
```

Go ahead—try it.

Removing a Statement

To delete a line from a program, type only the line number and then press the Enter key.

For example, to delete the statement that we just added to print 4, type:

12

and then press the Enter key.

Note: Remember the discussion of the Esc Key in the “Using DOS” chapter? Well, *don't* use the Esc key to try to delete a program line. The Esc key just erases the currently displayed line from the screen. It does not change the original line in the program; the original line will still remain in the program.

Summary

These sections on BASIC have told you about:

- Starting BASIC on your IBM Personal Computer
- Returning to DOS
- Loading and running the SAMPLES program that is provided on the DOS Diskette
- Loading and running the COMM program on the DOS Diskette
- Loading and running other BASIC programs
- Finding out what files are on a diskette with the FILES command
- Entering, saving, running, listing, and editing a program of your own.

As you become more familiar with running the BASIC programs you acquire or if you want to start writing your own programs in BASIC, use the *IBM Personal Computer BASIC* book. In it you will find alternative methods and much more detailed information than that we've given you here.

We hope this chapter has helped to get you started using your computer quickly. So start up the SAMPLES program and go!

SECTION 4. PROBLEM DETERMINATION PROCEDURES

Contents

Introduction	4-3
What is Problem Determination?	4-3
Power On Diagnostics	4-4
Error Examples	4-7
Service Information	4-10
Printer Problem Determination Procedures	4-11
Printer Problem Chart	4-12
Using Diagnostic Aids	4-13
Loading Diskette	4-17
Loading Cassette	4-18
Running Test	4-20
Summary	4-45

Notes:



Introduction

What is Problem Determination?

Problem determination is a set of procedures to help you resolve operational or system failures. This guide will direct you to make a series of observations and answer YES or NO when checking the results. By following the steps outlined in this guide, you can tell if service is needed, or what action to take to make your system operational again.

Part of your Problem Determination may include loading the Diagnostic Aids Diskette or Cassette.

The Diagnostic Aids contains a series of tests to help you locate a problem with any of the four components of your system. These four units are known as Customer Replaceable Units (CRUs) and consist of the System Unit, Keyboard, Display and Printer. You will find your Diagnostic Aids located in the rear of "Guide to Operations."

Power On Diagnostics

WARNING: Always position System Unit switch to OFF and remove power cord from wall outlet before checking cables or connectors.

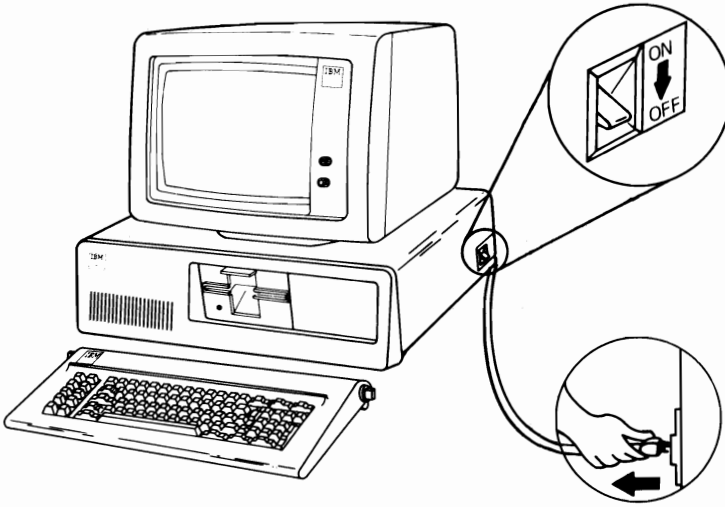

1.
 - Use a working lamp to check wall outlet.
 - Remove and reinstall each cable to ensure proper electrical connection.
 - Now that all cables have been checked, go to Step 2.

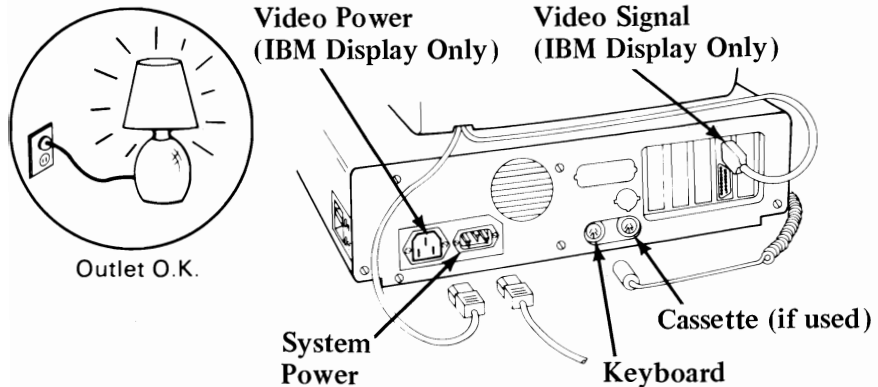

2. What's going to happen when you position the System Unit switch to ON?

- You will see something on the screen.

Maybe

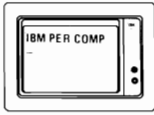

Maybe

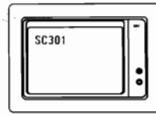

Maybe nothing

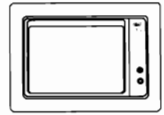

- You will hear something from the System Unit.

Maybe 1 short
beep

Maybe 1 long beep
1 short beep

Maybe nothing

- Make note of what you will see and hear.

The normal three responses are:

1. Cursor will appear on screen in approximately 4 seconds.
 2. One short beep will be heard after memory is tested.
 3. IBM Personal Computer will appear on the screen.
- Position System Unit power switch to ON.
 - Turn brightness and contrast knobs fully clockwise (CW).

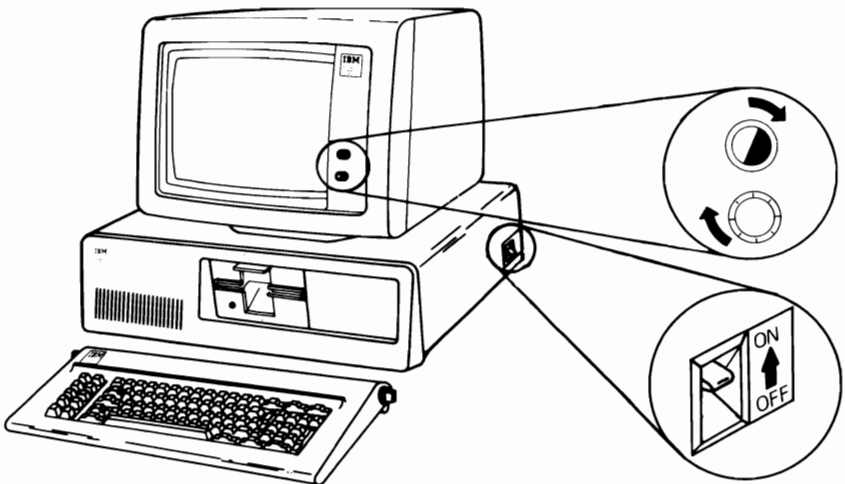

3. Were there three responses?

- If there was a screen response, adjust contrast and brightness knobs for eye comfort.
- If responses were missing or incorrect, note what you saw or heard on the bottom of page.
- If you missed the responses, power off, wait 5 seconds and power on again.

Here are the correct responses:



1. Cursor will appear on screen in approximately 4 seconds.
2. One short beep will be heard after memory is tested.
3. IBM Personal Computer will appear on screen.

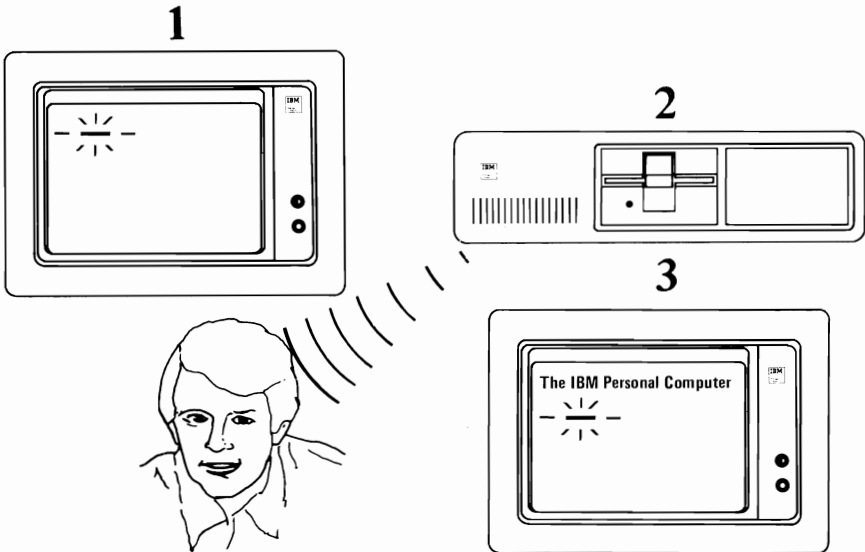

Screen Response

Audio Response (Beep)

Write Here

Write Here

Error Examples

4. Choose the responses that match what your system did in the following examples.

EXAMPLE 1

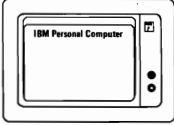
Correct Screen
IBM Personal Computer

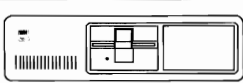

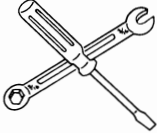
Correct response
1 short beep



* System OK

*Your system is ready to load Diagnostic Aids or your operating program.

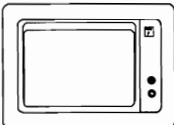
Go to Step 1. Using Diagnostic Aids.

EXAMPLE 2

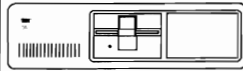

Does not apply, may display anything

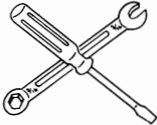

Any response other than 1 short beep

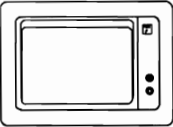

Likely Problem
System Unit

EXAMPLE 3

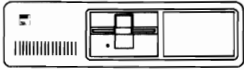
Note: Error messages *may* or *may not* remain on screen.
So look quickly. *X* means any number will appear.

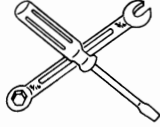

Error messages
XXX 201 601 131 Parity Check X

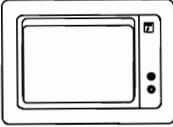

1 short beep

Likely problem
System Unit

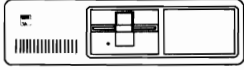
EXAMPLE 4

XXXX 301

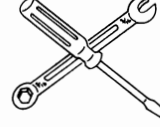
1 short beep



Likely Problem
Keyboard*

*Before having keyboard serviced:

- Position System Unit switch to OFF.
- Is keyboard plugged into cassette connector?
- Are there any obvious objects or foreign material on keyboard?

If after having keyboard serviced and error 301 still appears have **System Unit** serviced.

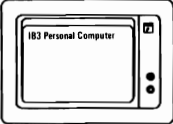
EXAMPLE 5



Wrong or Random characters or no cursor

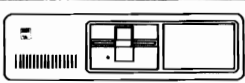

1 short beep

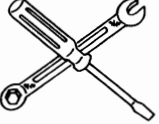

Likely problem

System Unit

Note: If using TV as your monitor, verify that color is correct by disconnecting from System Unit.

EXAMPLE 6

Color monitor only.

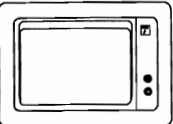

Screen has wrong or no color

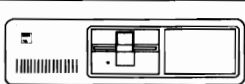

1 short beep

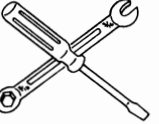

Likely problem

System Unit

EXAMPLE 7

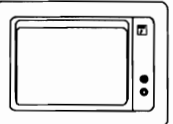

Obvious TV type problems (i.e. rolling screen or shadows)

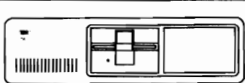

1 short beep

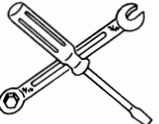

Likely problem

Display

After having display serviced and problem still exists have **System Unit** serviced.

Go to Step 5.

Service Information

5. Once you have determined which component of your system has a problem, follow the procedures listed below:

- Position power switch to OFF.
- Remove power cord from wall outlet.
- Disconnect failing unit.
- Have failing unit serviced.

If after following Steps 1 through 5 your IBM Personal Computer still has a problem, go to Diagnostic Aids.

Note: In using Diagnostic Aids, you will be asked to record an *Error Message*. This information is needed to aid in getting your system serviced.

Error Message Example

00014			} Record this information
ERROR SYSTEM UNIT	408		

Note: If you have a non-printer problem, continue with Diagnostic Aids.

If you have an obvious printer problem, continue with "Printer Problem Determination Procedures" on the next page.

Printer Problem Determination Procedures

CAUTION: When you are asked to remove the Printer signal cable, always position power switch to OFF on the Printer and the System Unit.

Notes:

1. When you are asked to run a test, do not forget to position the power switches to ON.
2. Printer will not appear when reviewing the options available screen with the printer uncabled.
3. Any help you will need to run Self-test or load supplies can be found in Section 3. "Operations."

Preliminary Steps:

- Check wall outlet (use desk lamp, etc.).
- Is Printer plugged into wall outlet?
- Verify the Printer cable is connected properly at the Printer and at the System Unit.
- If any lights on control panel do not work, but Printer functions normally, have *Printer* serviced.

Note: You may lose data if the Printer power switch is in the OFF position while you are sending data to the Printer from the System Unit.

Select the column on the next page that best fits your Printer symptom.

Printer Problem Chart

Partial or No Printing	Beeps and Forms	Error Messages
<p>Is the ribbon new and installed properly?</p> <p><i>NO</i>—Correct and retry.</p> <p><i>YES</i>—Disconnect Printer cable and run Self-test.</p> <p>Does the printout look like it should?</p> <p><i>NO</i>—Have Printer and cable serviced.</p> <p><i>YES</i>—Reconnect cable and go to “Error Messages” column.</p>	<p>Are the forms installed and feeding properly?</p> <p><i>NO</i>—Check the list below for common problems.</p> <ol style="list-style-type: none"> 1. Forms feed path is not straight. 2. Obstructions in forms path. 3. Tractors adjusted properly. <p>If problem is not listed have Printer serviced.</p> <p>If forms are installed properly and Printer beeps continuously, have Printer and cable serviced.</p>	<p>Is Printer cabled properly and secure?</p> <p><i>NO</i>—Correct and retry.</p> <p><i>YES</i>—Run Diagnostic aids and record any error message.</p> <p>Did you see error 199, 432, 901, or 1401?</p> <p><i>NO</i>—Recheck your software program. If no error exists have System Unit and cable serviced.</p> <p><i>YES</i>—Disconnect Printer cable and rerun Diagnostic aids.</p> <p>Did you see the same error message?</p> <p><i>NO</i>—Have Printer and cable serviced.</p> <p><i>YES</i>—Have System Unit and cable serviced.</p>

Using Diagnostic Aids

Please refer to the following before continuing.

Do's and Don'ts for Handling Diskettes

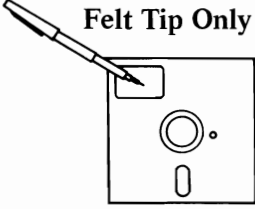
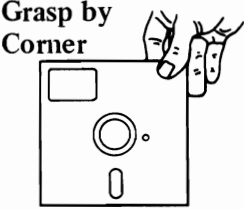
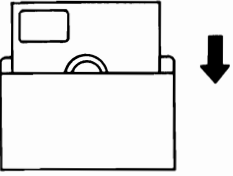
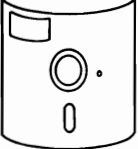
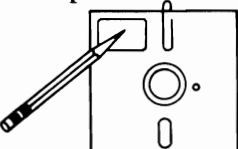
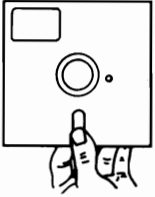
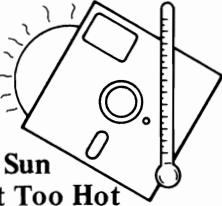
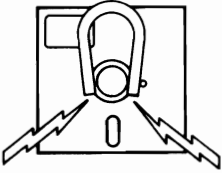
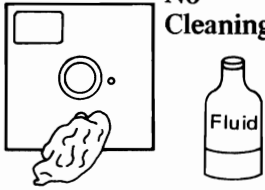
DO's		
<p>Felt Tip Only</p> 	<p>Grasp by Corner</p> 	<p>When Not In Use</p> 
DON'Ts		
<p>Don't Bend</p> 	<p>No Pencils, No Clips, No Ballpoints</p> 	<p>Don't Touch Disk</p> 
<p>No Sun Not Too Hot</p> 	<p>No Magnets</p> 	<p>No Cleaning</p> 

Note: This series of Problem Determination Procedures (PDP's) will be run using diskettes (cassette PDP's will be similar).

1. Select the diskette that is labeled Diagnostic Aids and a blank diskette from binder.

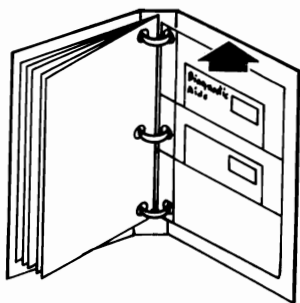

2. If you are using a home television or various monitors with your IBM Personal Computer and the screen looks similar to the examples on the following pages refer to the solution under each example.

EXAMPLE 1 When Using Diagnostic Aids Diskette or Cassette

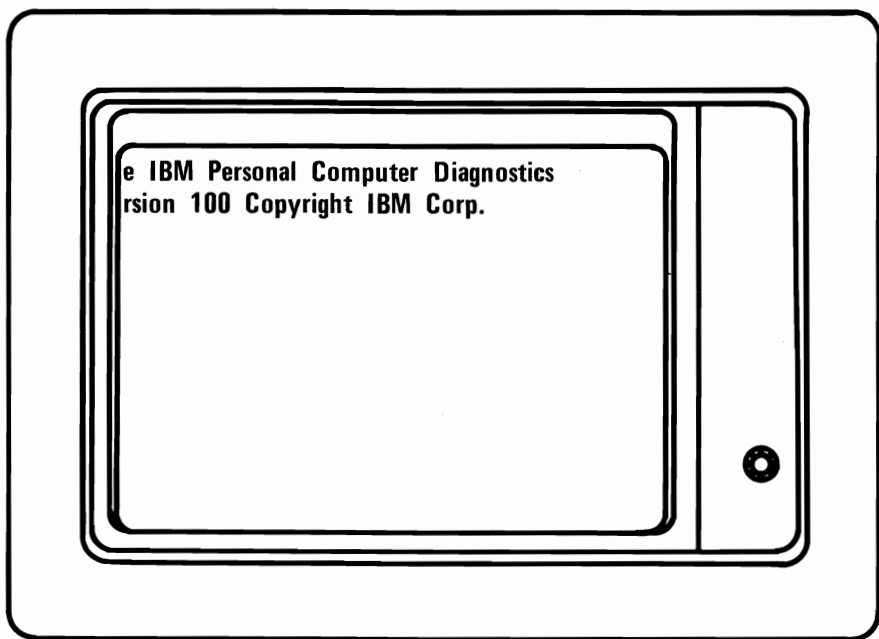

Solution: Press Function key  to move screen to the right.

Press Function key  to move screen to the left.

EXAMPLE 2 When Using Cassette System

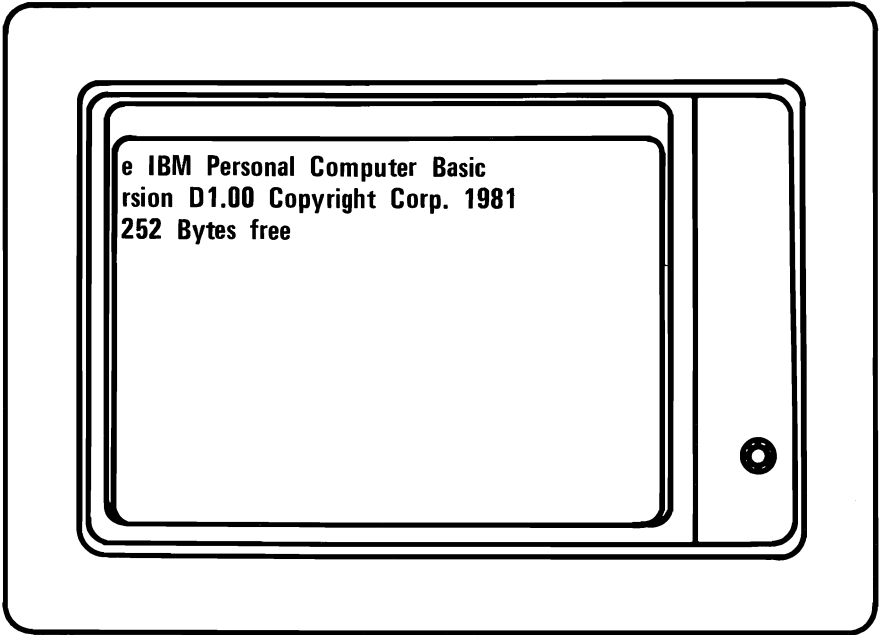

Solution: Refer to “OUT” command in Section 3. “Using BASIC.”

EXAMPLE 3 When Using Diskette System

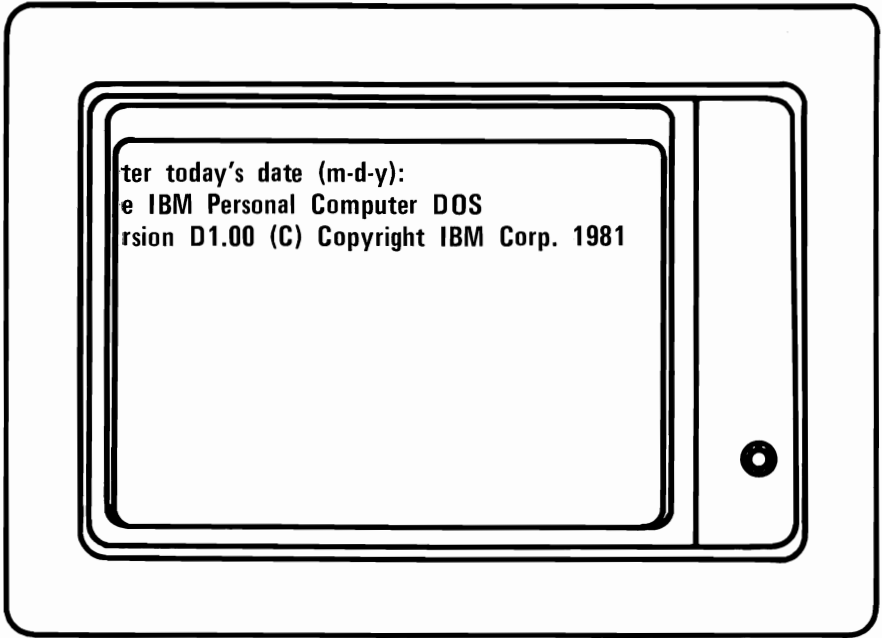

Solution: Refer to “MODE” command in Section 3. “Using DOS.”

Loading Diskette

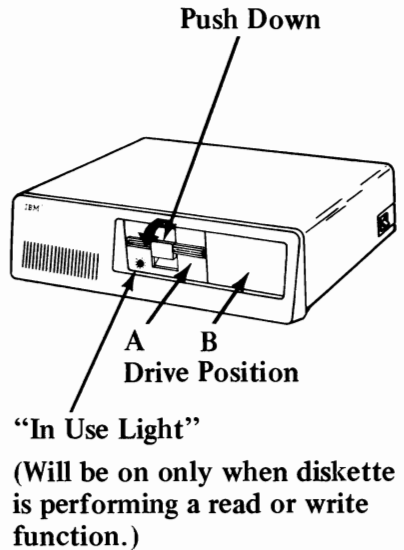
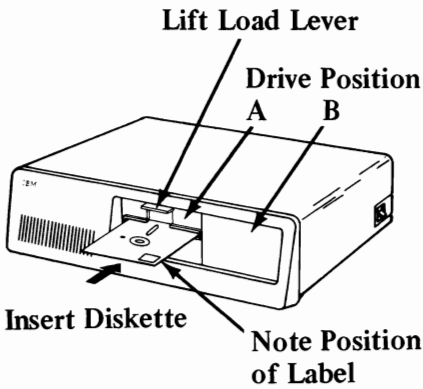

3. How to load Diagnostic Aids diskette:

- Position System Unit switch to OFF.
- Lift load lever.
- Insert diskette until rear stop is felt.
- Push down load lever.
- Position System Unit switch to ON.



Go to Step 5.

Loading Cassette

4. If you are using a cassette recorder to test your system, follow the procedures below:
- Familiarize yourself with your cassette users manual before continuing.
 - Insert Diagnostic Aids cassette.
 - Rewind to the beginning.
 - Position System Unit switch to ON. (Wait for the Self-test to complete.)
 - Turn volume on cassette recorder to high.
 - Press play on cassette recorder.
 - Type **load**"ldcass on keyboard.
 - Press  enter.
 - Look to verify that your cassette is turning.
 - Wait for "**ldcass .B found**" to appear on screen, then wait for "**OK**" to appear on screen.
 - Type **RUN** on keyboard.
 - Press  enter.
 - Wait for option frame, approximately a minute or two.
 - Look to verify that your cassette is turning.
 - When cassette is loaded, the screen will be similar to the figure on the following page.

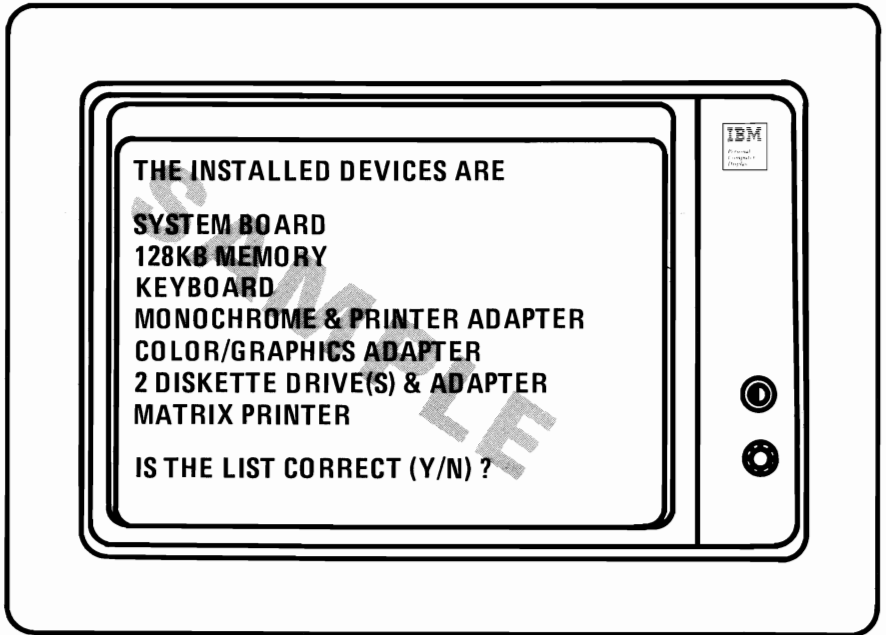

If you could not load your cassette the most likely causes are:

1. Cassette recorder.
2. Wrong or damaged cassette.
3. Keyboard failure.

Contact your place of purchase if you cannot continue.

Go to Step 11.

Running Test

5. Does the screen match the figure below?

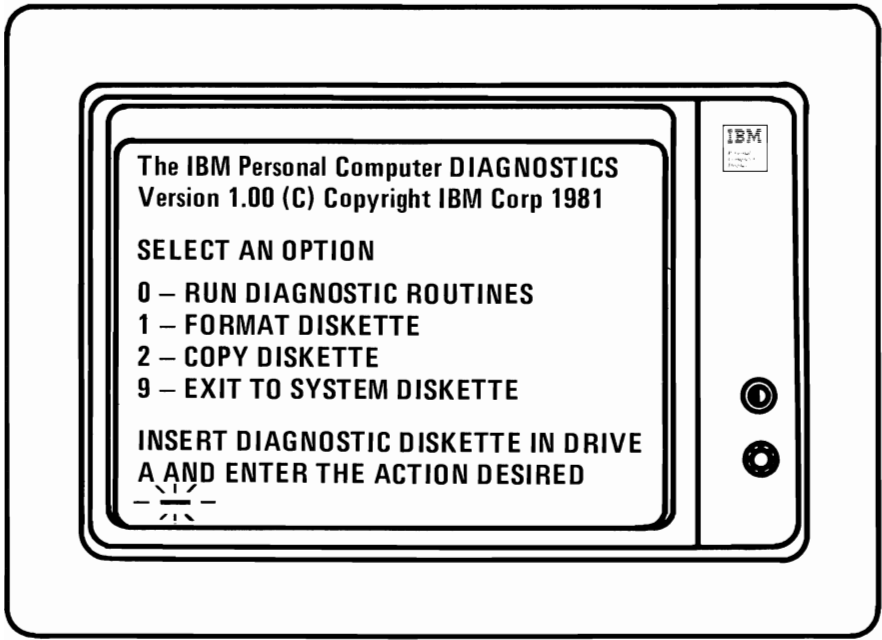

YES? – Go to Step 6.

NO? – Remove diskette.

- Was it “Diagnostic Aids” diskette located in “Guide to Operations”?
- Was it loaded properly? **Refer to Step 3.**
- Have *System Unit* serviced.

Note: If you are using a home television or various monitors as your display, you could experience data errors while using your Diskette Drive. This interference is easily cured by moving your television 12 inches away from your IBM Personal Computer.

When you can answer yes, go to Step 6.

6. The bottom line states "Enter Action Desired." Below this statement is a line called a cursor and it moves to the next position when key is pressed.

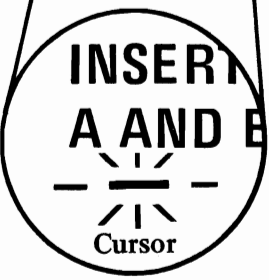
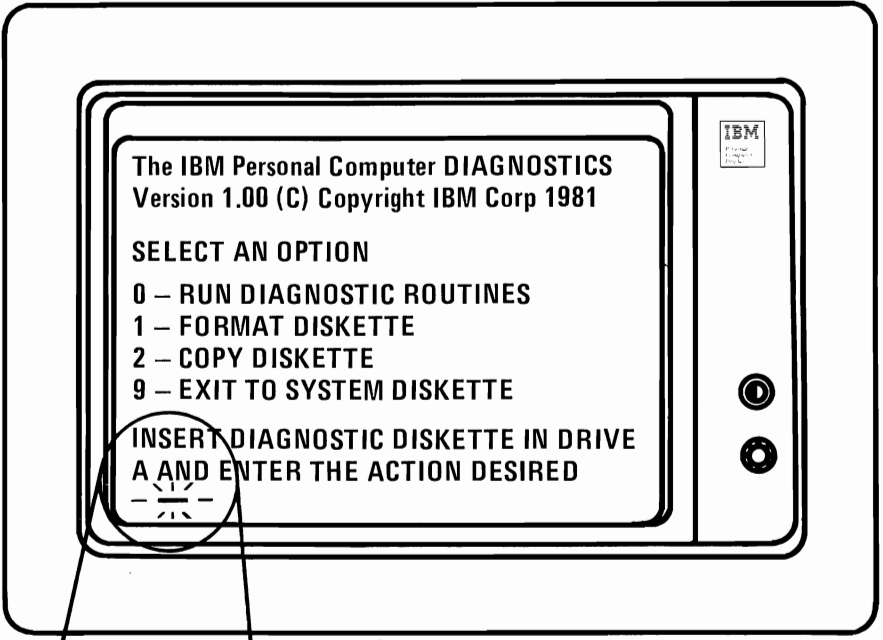

Go to Step 7.

7. Press  to select "Format Diskette Option," then press  enter.

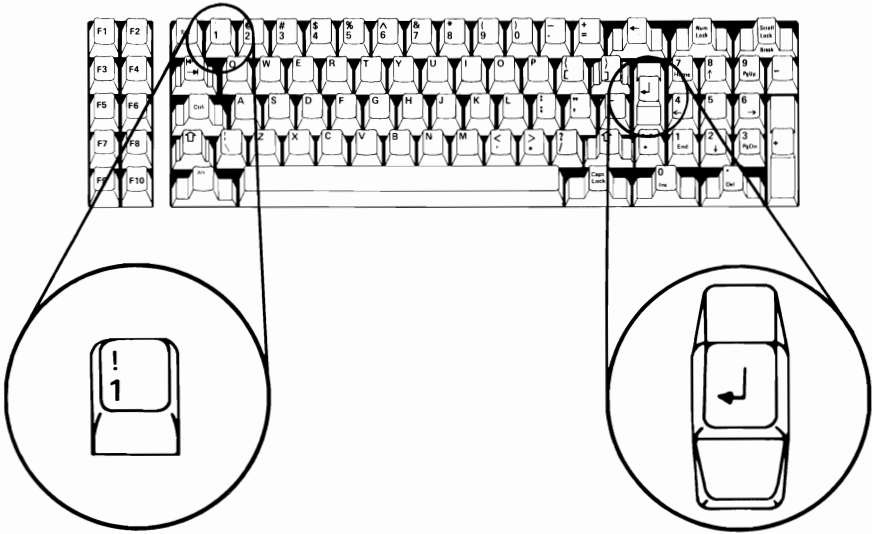

Step 7 continues on next page.

Does screen match the figure below?

YES? – Go to Step 8.

NO? – Have *Keyboard* serviced.

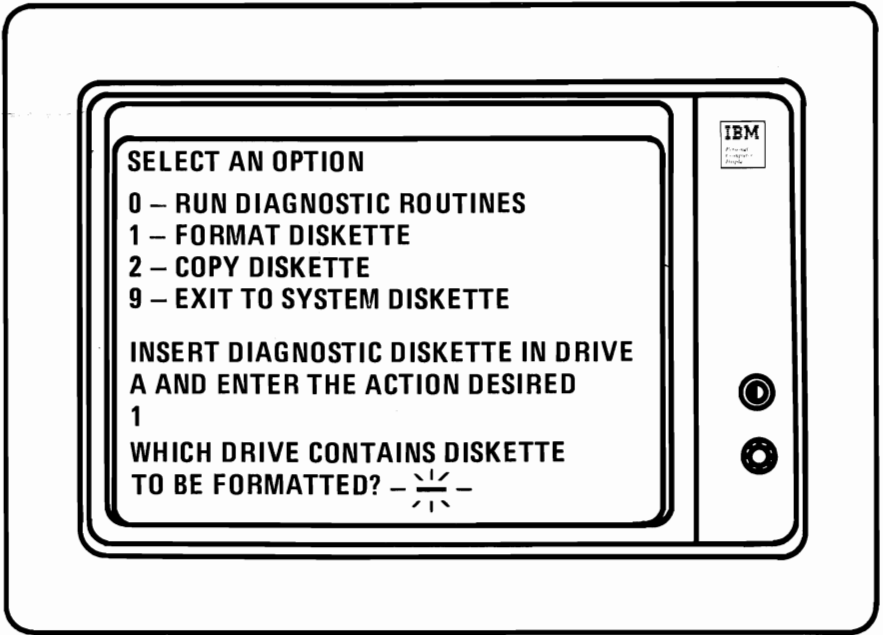

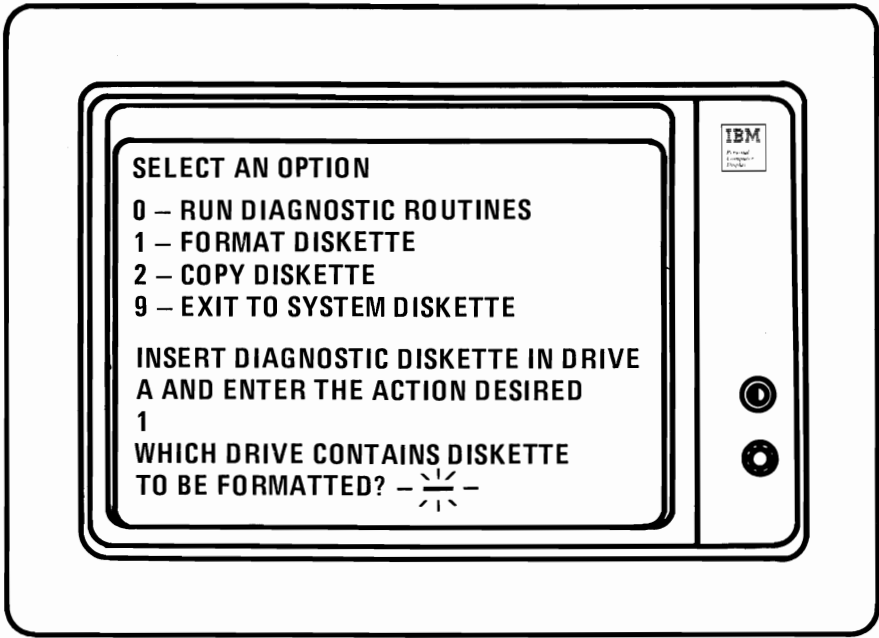

8. WARNING: Remove Diagnostic Aids diskette.

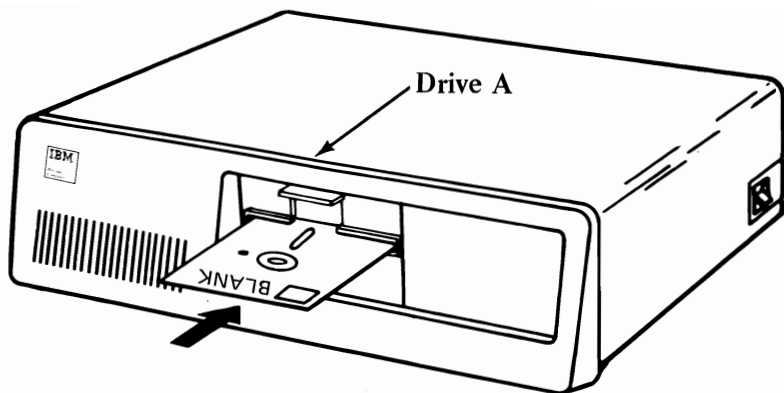

Step 8 continues on next page.



Insert blank diskette in drive A.

Press  then  enter.

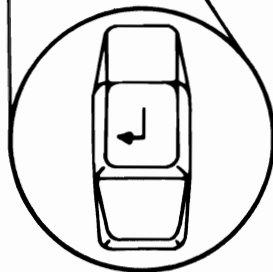
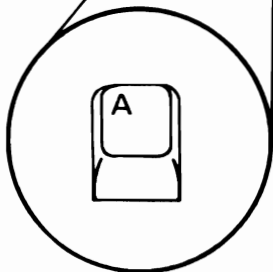
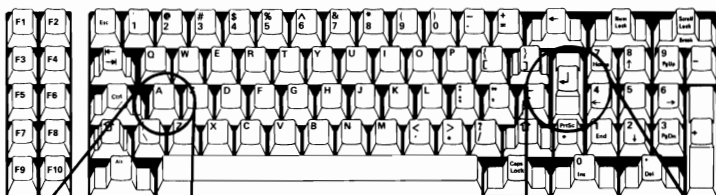

Go to Step 9.

Note: A blank diskette that has been formatted is called a “scratch” diskette.

- 9.
- The “in use” light will be on while a blank diskette is being formatted.
 - When light goes off, *remove* formatted diskette.
 - Reinsert Diagnostic Aids diskette in drive “A.”

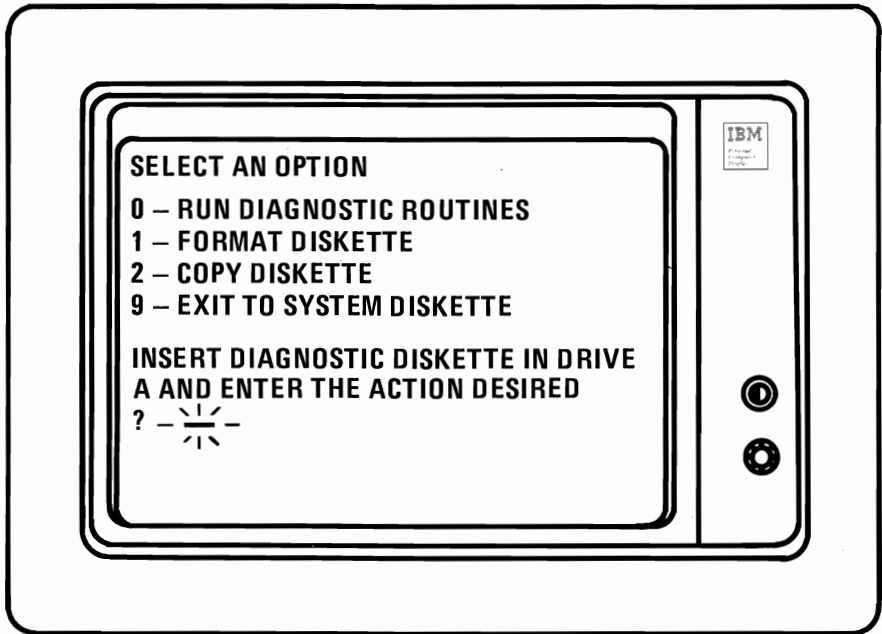

Does screen match figure below?



YES? – Go to Step 10.

- NO? –
- Was the diskette inserted properly?
 - Was the proper diskette used (blank then Diagnostic Aids)?
 - Try another blank diskette.
 - Record error message and have *System Unit* serviced.

10. Select the option "Run Diagnostic Routines."

Press  then  enter.

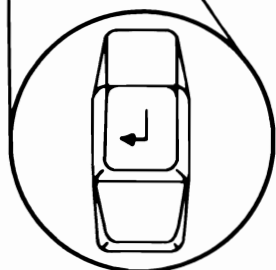
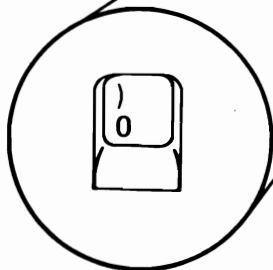
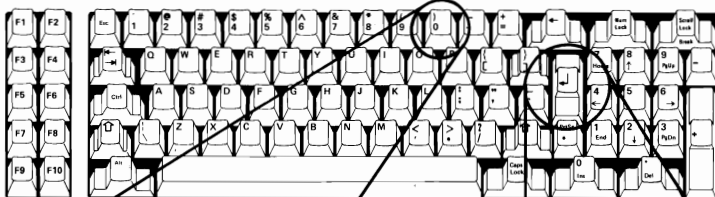
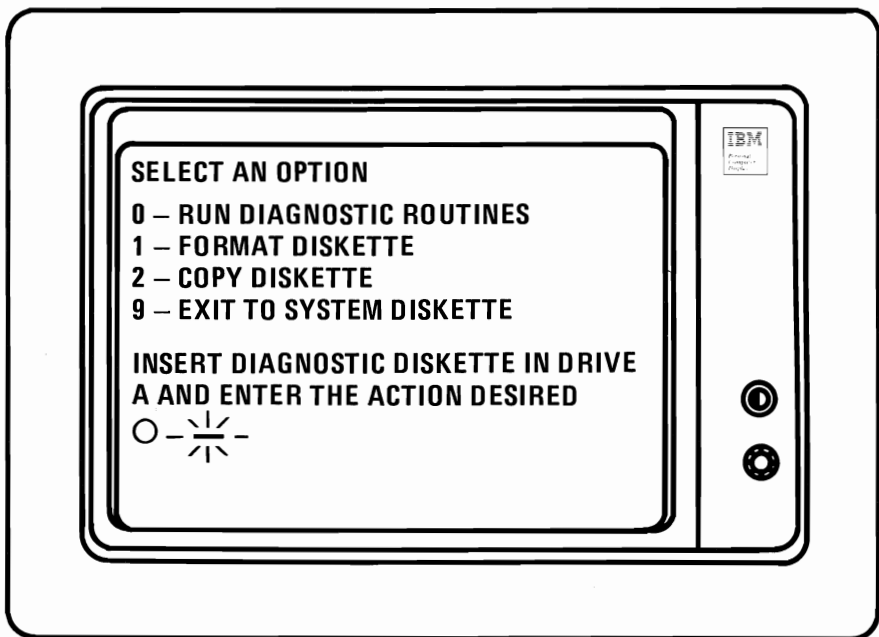

Go to Step 11.

11. This step will ask you to list your system hardware options.



Options Available

Check Options You Have

System Board	<input type="checkbox"/>
XXX KB Memory	<input type="checkbox"/>
Keyboard	<input type="checkbox"/>
Monochrome and Printer Adapter	<input type="checkbox"/>
Color/Graphics Adapter	<input type="checkbox"/>
X Diskette Drive(s) and Adapter	<input type="checkbox"/>
Parallel Printer Adapter	<input type="checkbox"/>
Async Communications Adapter	<input type="checkbox"/>
Game Control Adapter	<input type="checkbox"/>
Matrix Printer	<input type="checkbox"/>

Does the screen match the options you've checked?

YES? – Press  then  enter. **Go to Step 12.**

- NO? –
- Check to see that external options are connected and have power switch ON. (See ***Optional** on next page.)
 - If power switch was ON, press  then  enter.
 - Did you press  no because Printer was missing?

YES—Go to PDP Printer chart.

NO—Record error message and have **System Unit** serviced.

***Optional**—If external options did not have power switch ON and you want to recheck your options, use the following steps:

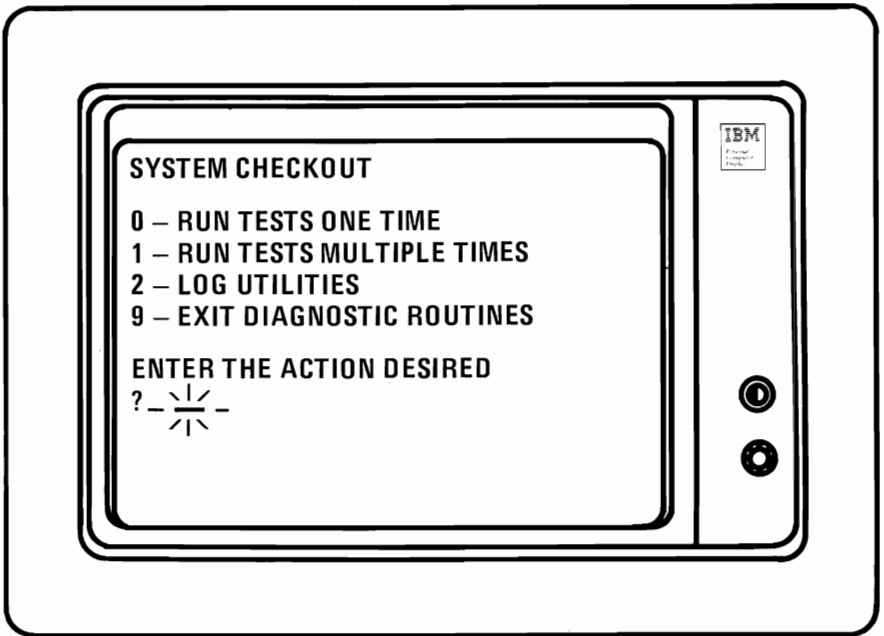

- Remove diskette.
- Power OFF.
- Power ON.
- Insert Diagnostic Aids Diskette.
- Start with **Step 1**.

12. The screen will match the figure below.



Go to Step 13.

13. Read all of this step before taking action.

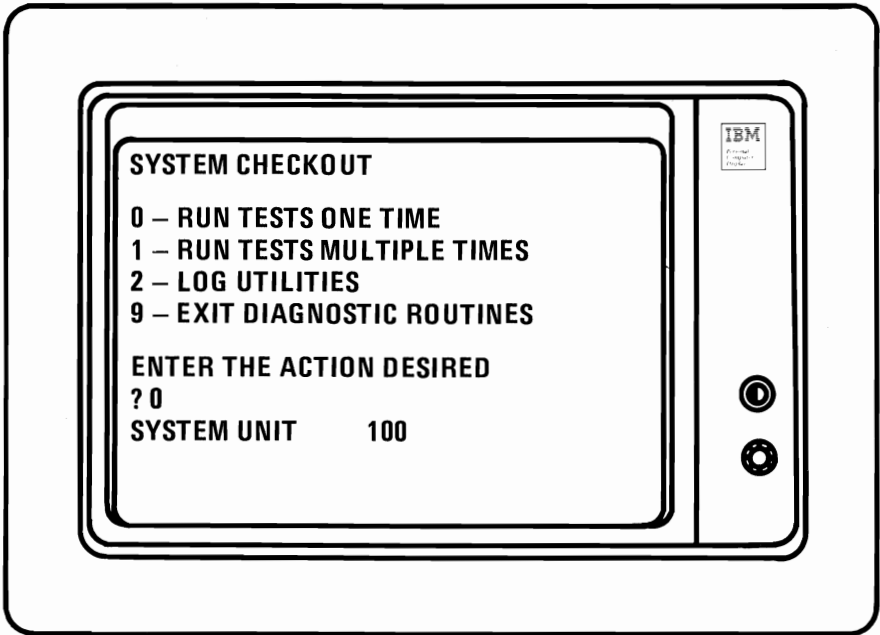

- Press  to select **"Run Tests One Time."**
- Press  enter.
- After pressing enter, the screen will match the figure below **"System Unit 100."** There will be a time delay while the System Unit is checking memory. Screen will change to **Step 14** with no action taken.

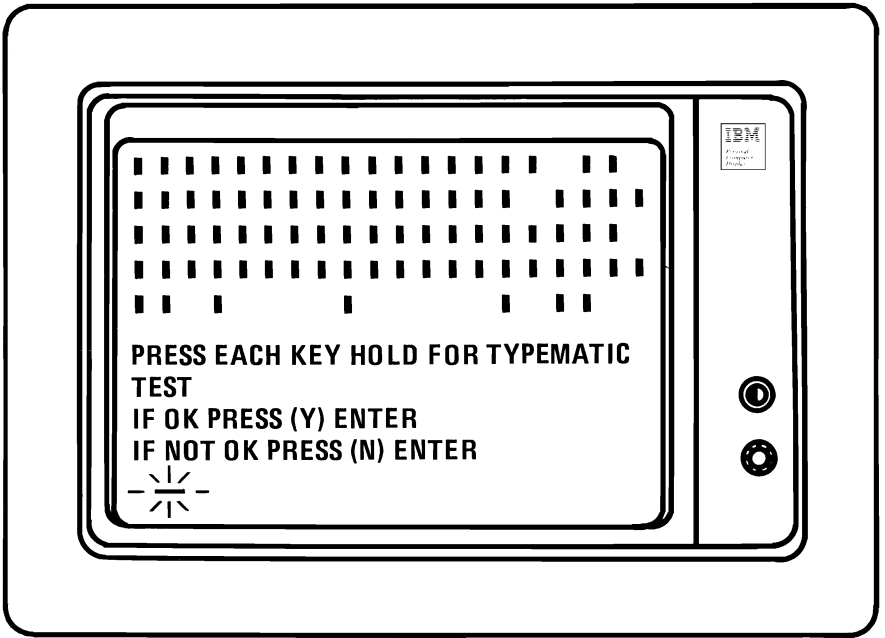

14. Does screen match the figure below?



YES? — Press each key once, then go to Step 15.

NO? — Press  then  enter. Record error message and have *System Unit* serviced.

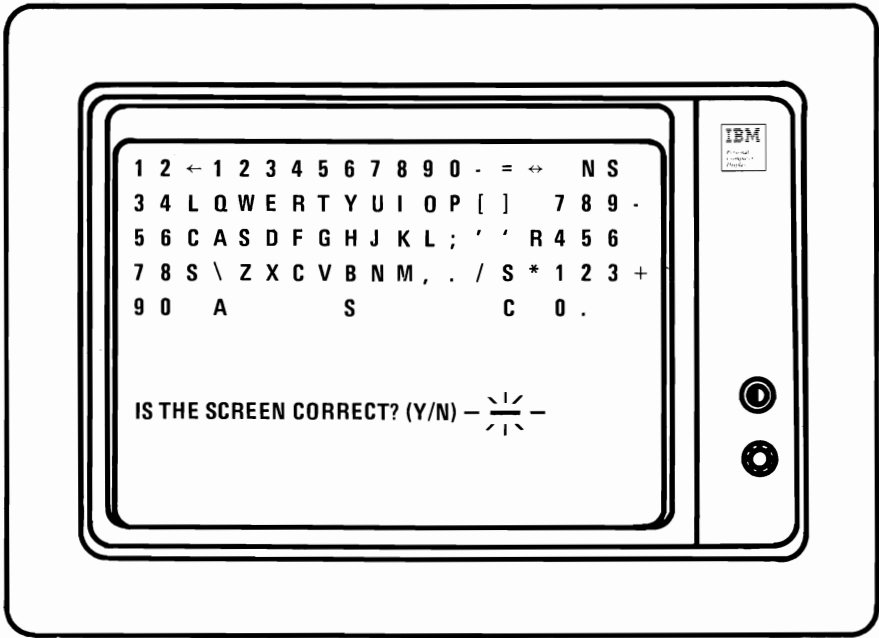

15. Does screen match the figure below?



YES? — Press and **hold** any key. The corresponding key on screen will flash. This is the Typematic test.

Press  then  enter. Go to Step 16.

NO? — If any block did not change to a character have **Keyboard** serviced.

If Typematic test failed, press  then  enter.

Record error message and have **System Unit** serviced.

Note: Steps 16 through 28 will apply to color and black and white screens. Screen differences will be noted when they occur.

16. Does screen match the figure below?

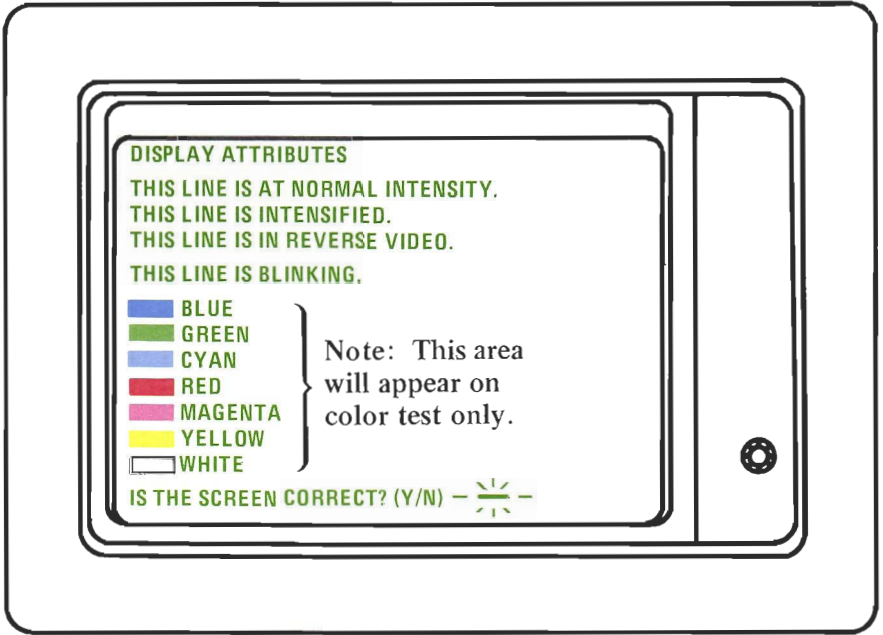

YES? – Press  then  enter. Go to Step 17.

NO? – Press  then  enter. Record error message and have *System Unit* serviced.

The non-IBM devices in this manual are for illustration only, and their use here does not constitute a recommendation or an endorsement by IBM. Selection, interconnection, and use of another manufacturer's device, are the sole responsibility of the customer.

17. Does screen match the figure below?

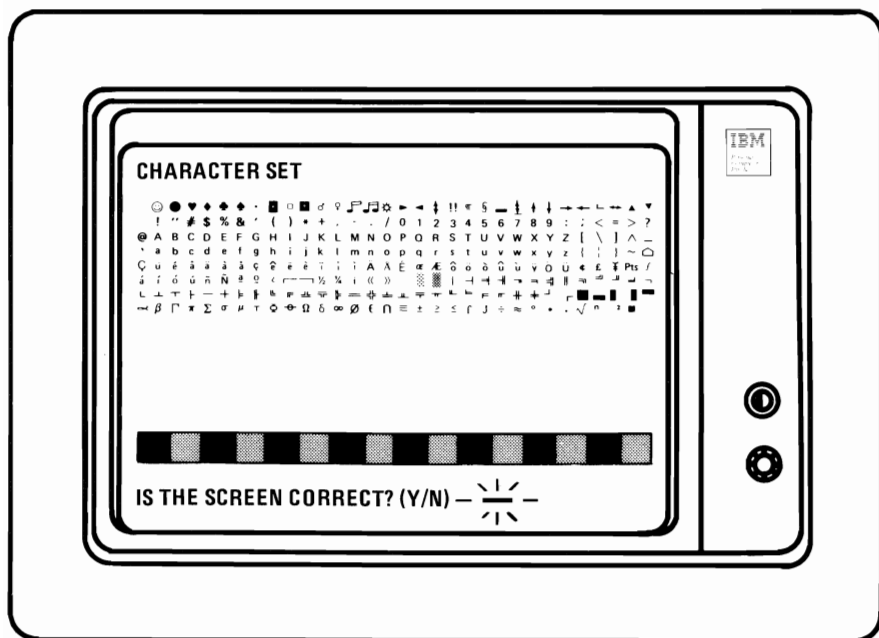



YES? — Press  then  enter. **Go to Step 18.**

NO? — Press  then  enter. Record error message and have **System Unit** serviced.

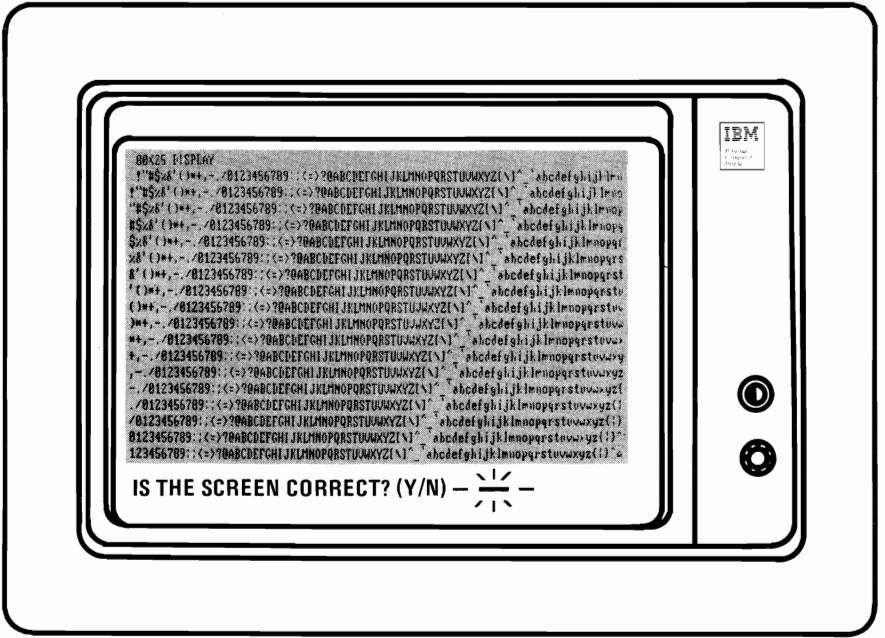
18. Does screen match the figure below?



YES? – Press  then  enter. Go to Step 19.

NO? – Press  then  enter. Record error message and have *System Unit* serviced.

Note: If error is **432**, go to Printer Problem Determination Procedures.



19. This step for color only.

If you are using a black and white monitor, go to Step 26.

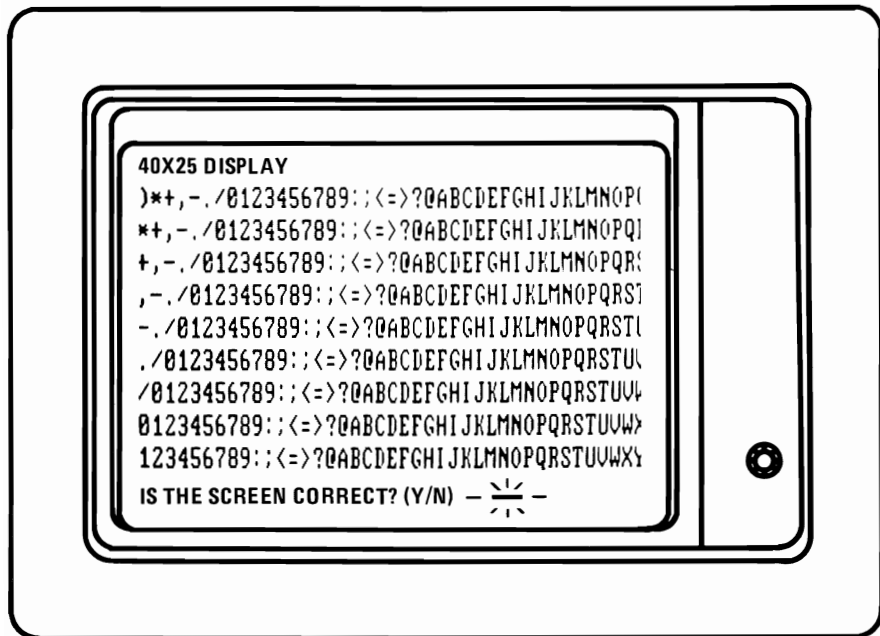
Does screen match the figure below?



YES? — Press  then  enter. Go to Step 20.

NO? — Press  then  enter. Record error message and have *System Unit* serviced.

20. This step for color only.

Does screen match the figure below?

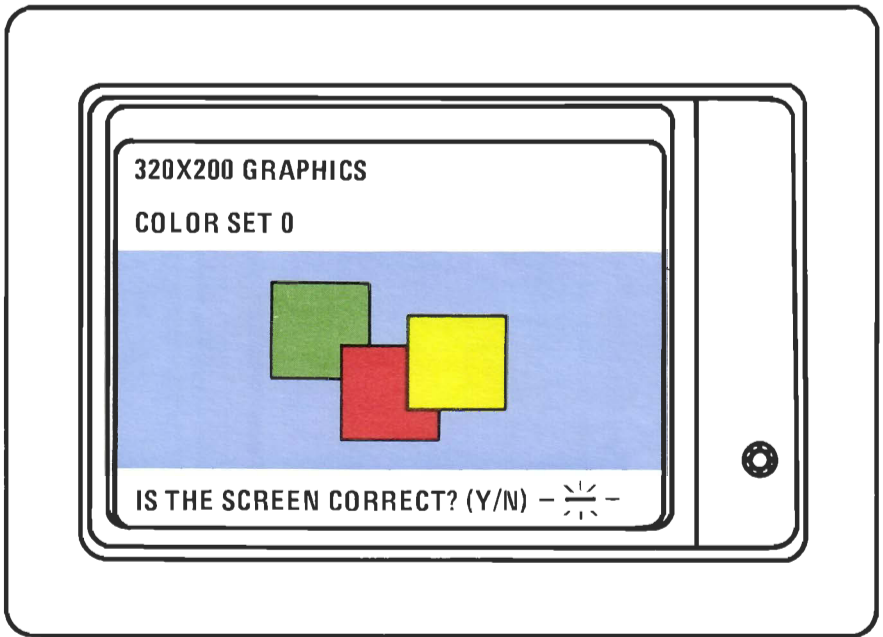

YES? – Press  then  enter. Go to Step 21.

NO? – Press  then  enter. Record error message and have *System Unit* serviced.

21. This step for color only.

Does screen match the figure below?

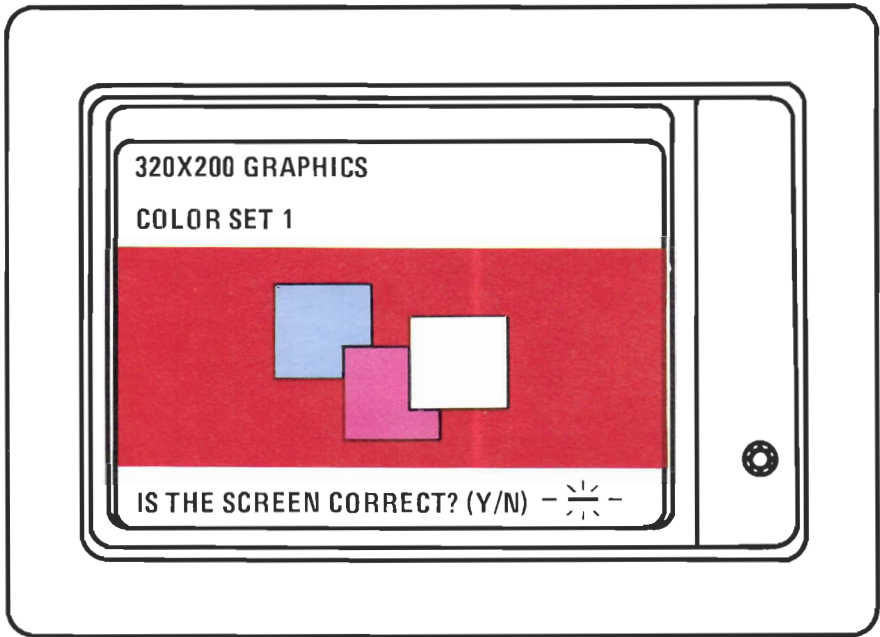

YES? – Press  then  enter. Go to Step 22.

NO? – Press  then  enter. Record error message and have *System Unit* serviced.

22. This step for color only.

Does screen match the figure below?

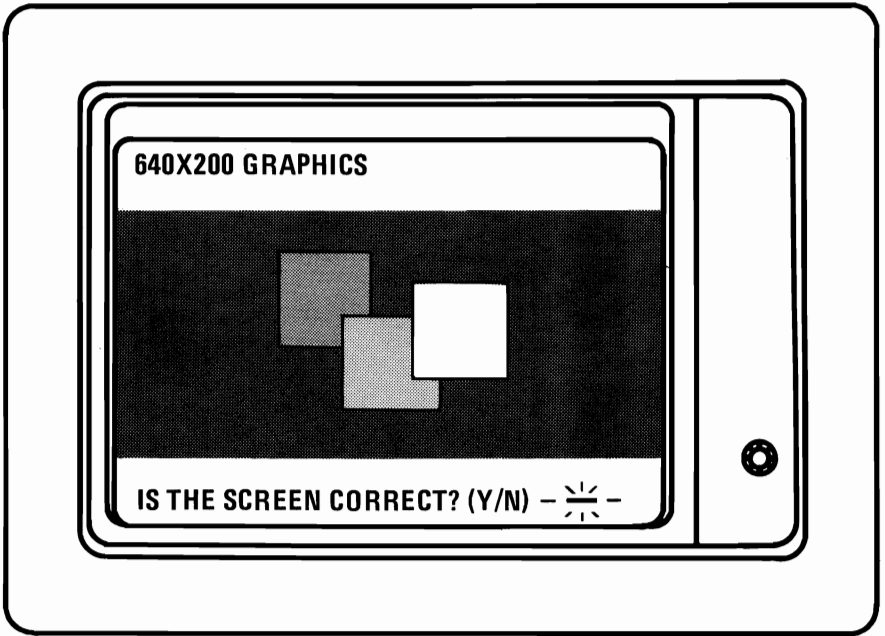

YES? – Press  then  enter. Go to Step 23.

NO? – Press  then  enter. Record error message and have *System Unit* serviced.

23. This step for color only.

Does screen match the figure below?

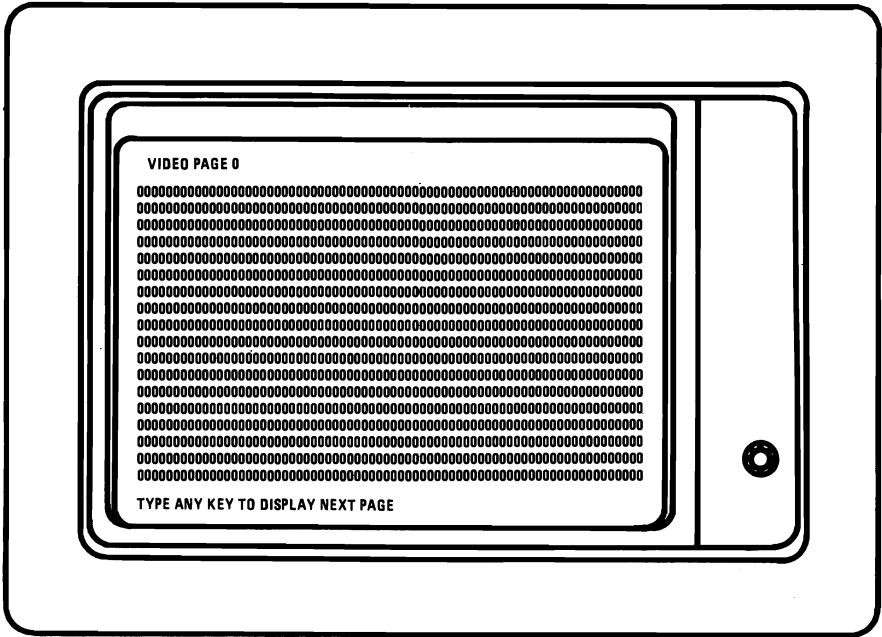

YES? — Press any key to display next screen. Go to Step 24.

NO? — Press  then  enter. Record error message and have *System Unit* serviced.

24. This step for color only.

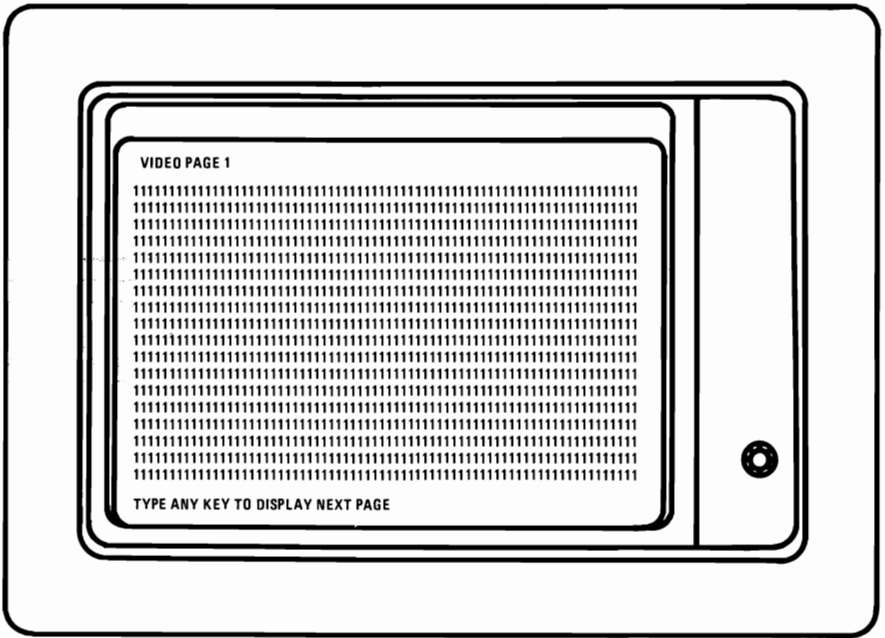

Press any key to display next page.



Go to Step 25.

25. This step for color only.

Press any key until **VIDEO PAGE 7** appears.

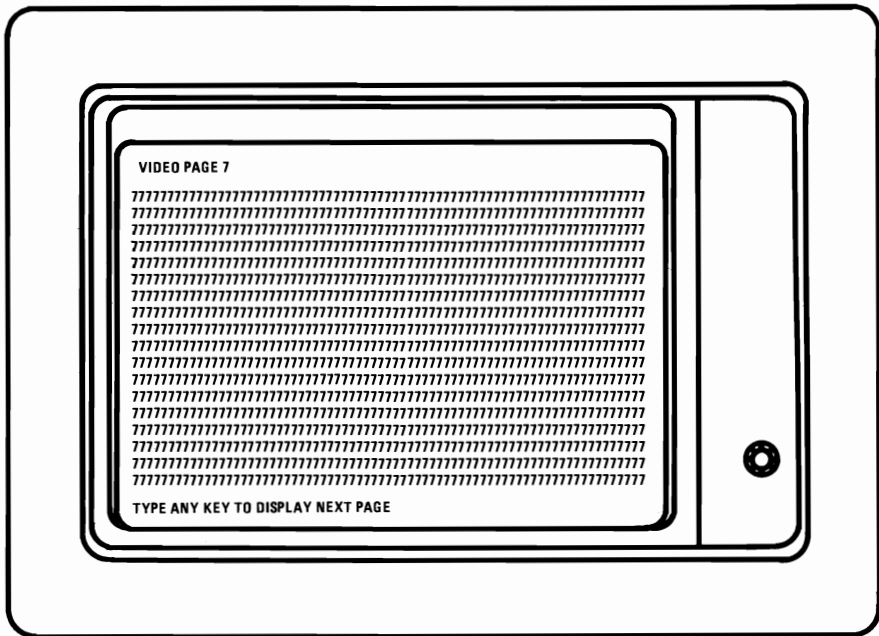
Were pages 0-7 displayed?



YES? — Press  then  enter. Go to Step 26.

NO? — Press  then  enter. Record error message and have *System Unit* serviced.

26. WARNING: Remove Diagnostic Aids diskette.

The screen will match the figure below.

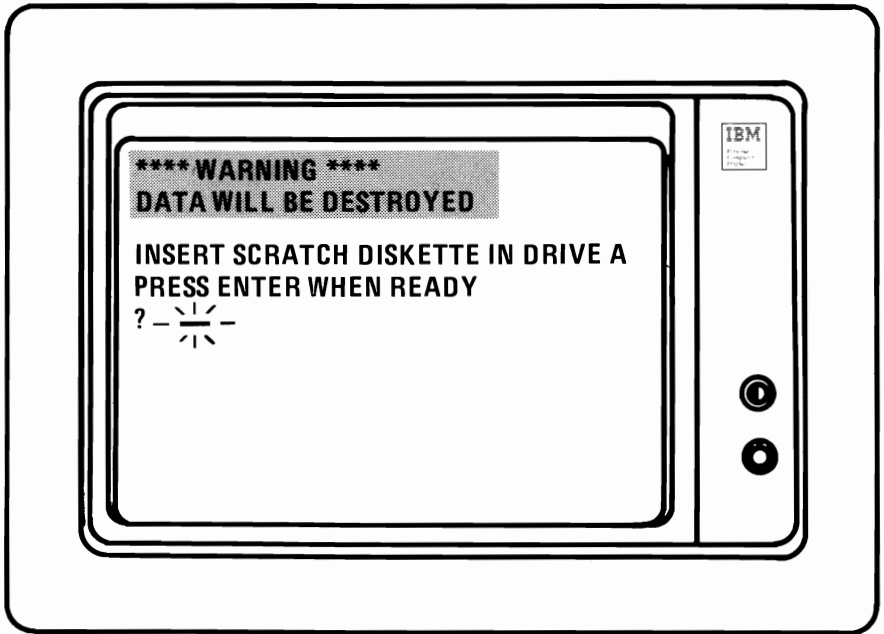

Insert scratch diskette in drive "A." (Remember—a scratch diskette is the blank diskette that you formatted in Steps 7 through 9.) **Go to Step 27.**

Note: If your IBM Personal Computer has two drives, the test will be repeated in the "B" drive.

27. When the "in use" light goes out, please continue.

Does the screen match the figure below?

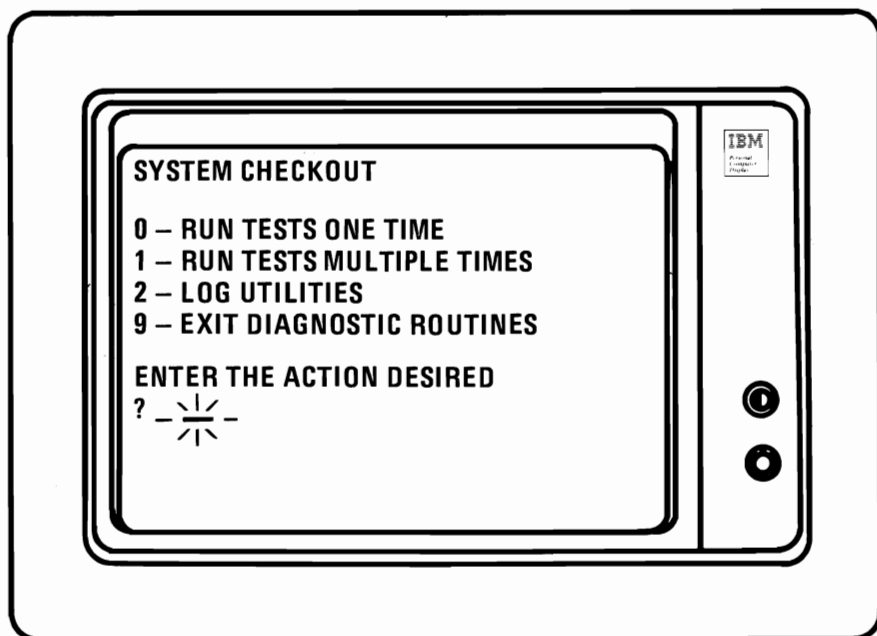

YES - Remove scratch diskette and return both diskettes to their protective covers.

NO - If error is **432**, **901**, or **1401** go to Printer Problem Determination Procedures. Any other error, have *System Unit* serviced.

Note: If you have a Printer the test will conclude by printing the sample below:

```
0123456789 | | (<=>
@ABCDEFGHIJKLMN
PQRSTUVWXYZ [ \ ] ^
`abcdefghijklmnop
pqrstuvwxyz { ; } ~
! " # $ % & ' ( ) * + , - .
' . : ; < > =
```

Go to Step 28.

28. Was the sample printout correct?

YES – Continue with “**Summary.**”

NO – Have **Printer and cable** serviced.

Summary

This concludes **Problem Determination Procedures**. Your **IBM Personal Computer** should be ready to load your operating program.

If you encounter further problems, contact your place of purchase for additional help.

Notes:



SECTION 5. OPTIONS

Contents

Introduction	Options 5-3
Cabling Your IBM Monochrome Display	Display 5-1
IBM Monochrome Display and Parallel Printer Adapter Option Installation	Display 5-3
Color/Graphics Monitor Adapter Option Installation	Display 5-21

IBM 80 CPS Matrix Printer Option

Installation	Printer 5-1
Parallel Printer Adapter Option Installation	Printer 5-15

5¼" Diskette Drive	Diskette 5-1
--------------------------	--------------

5¼" Diskette Drive Adapter	Diskette 5-33
----------------------------------	---------------

16KB Memory Module Kit Option

Installation	Memory 5-1
32KB Memory Expansion Option Installation ...	Memory 5-21
64KB Memory Expansion Option Installation ...	Memory 5-41

Game Control Adapter	General 5-1
----------------------------	-------------

Asynchronous Communications Adapter	General 5-15
---	--------------

Notes:



Introduction

This section of the Guide to Operations will help you install any options you have purchased for your IBM Personal Computer. As you add options to your System, the documentation you received will be inserted under the proper bleeder tab as shown on the Content page.

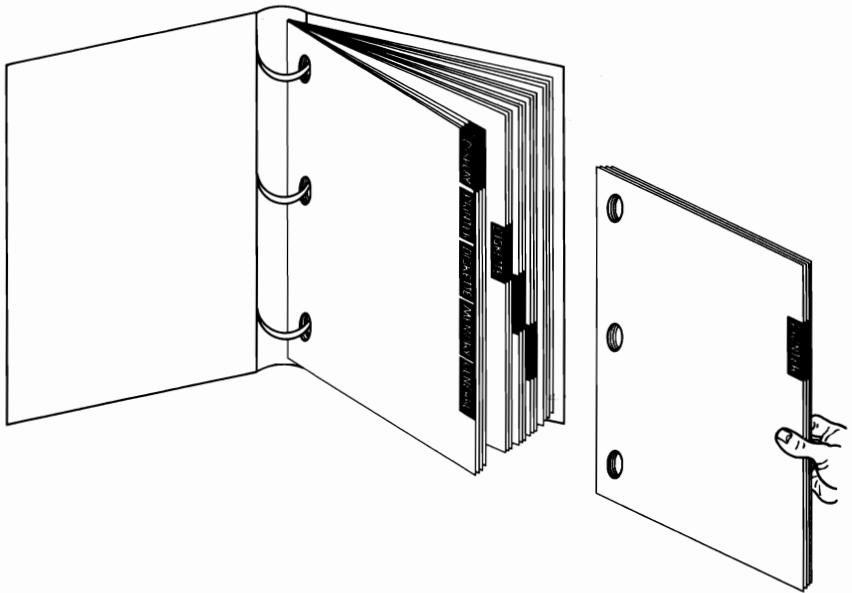

Notes:



SECTION 6. RELOCATE

Contents

Physical Preparation of the System	Relocate 6-3
Short Distance Relocate	Relocate 6-6
Long Distance Relocate for System Unit	Relocate 6-7
Long Distance Relocate for Keyboard	Relocate 6-8
Long Distance Relocate for IBM Monochrome Display	Relocate 6-9
Long Distance Relocate for IBM 80 CPS Matrix Printer	Relocate 6-10
Setup At New Location	Relocate 6-11

Notes:



Physical Preparation of the System

1. Remove diskettes from diskette drive unit.

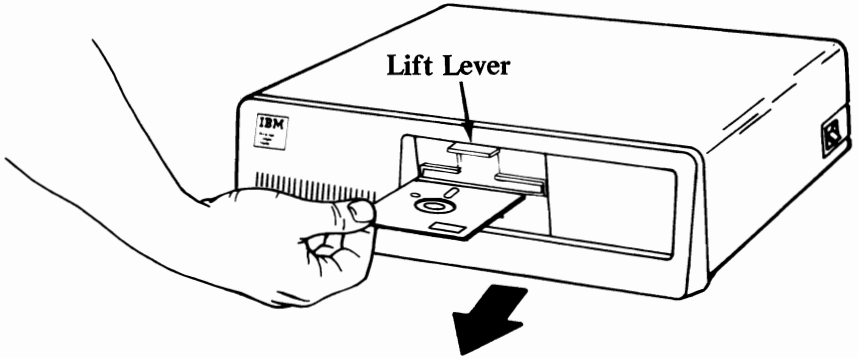

2. Position power switches to OFF on all units (System Unit, Printer, etc.).

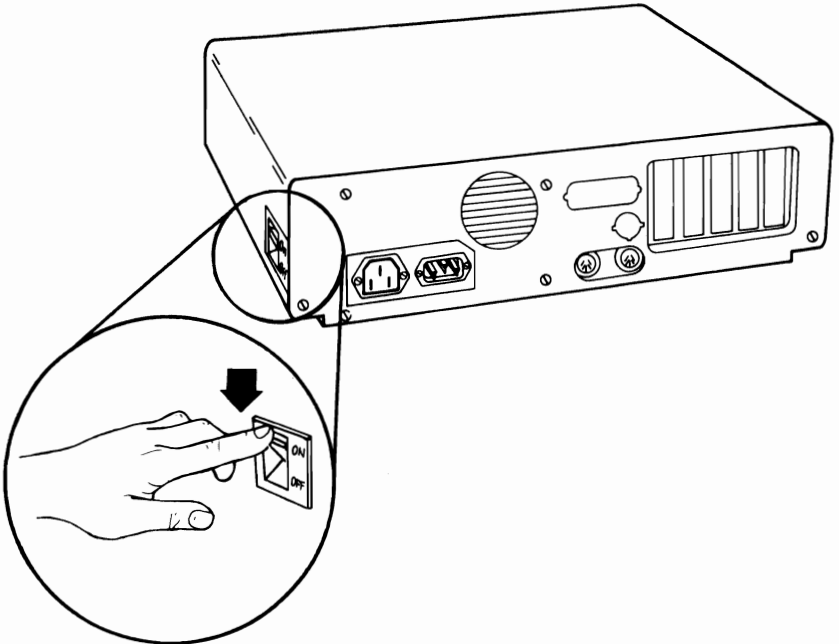

3. Disconnect power cord(s) and/or printer option.

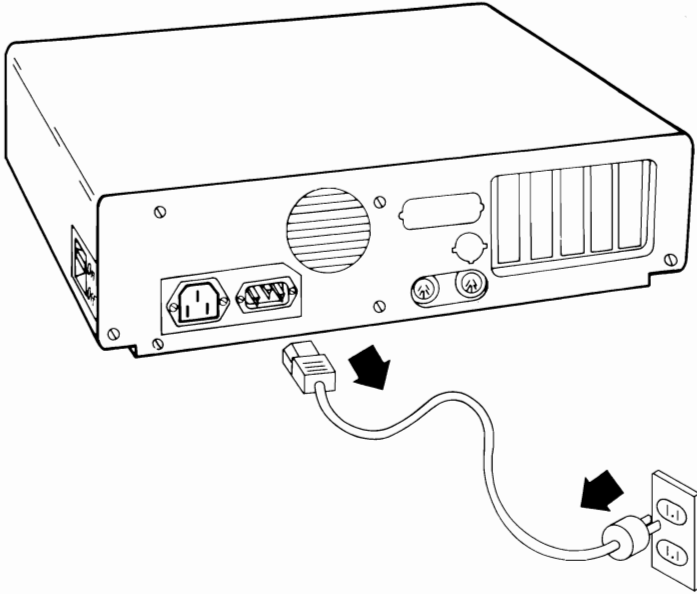

4. Carefully disconnect all cables.

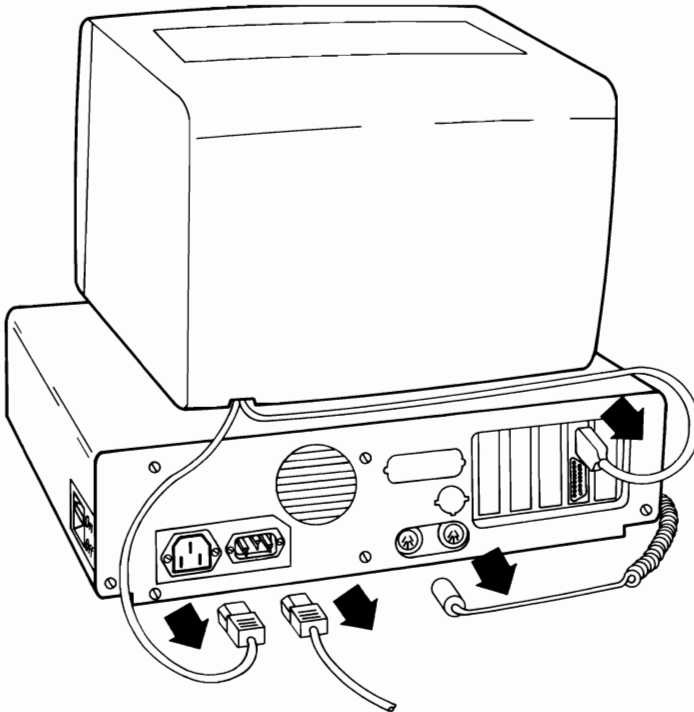

5. Coil the cables to protect the connectors.

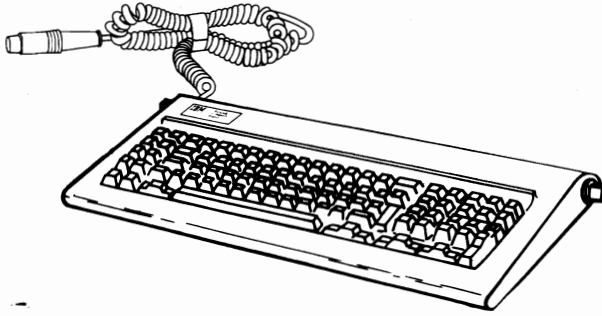

6. Tape coiled cables to System Unit so the unit may be carried safely. (IBM recommends filament or masking tape.)

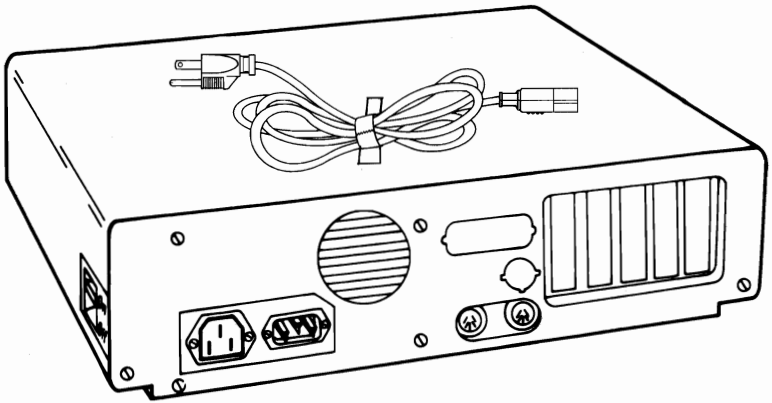

Short Distance Relocate

Move each unit separately.

Note: A second person may be helpful (doors, stairs, etc.).

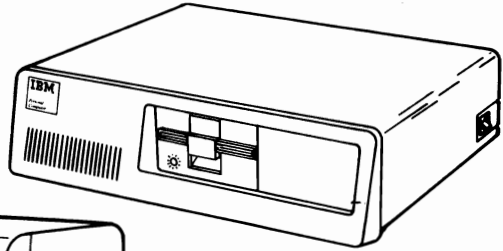

System Unit

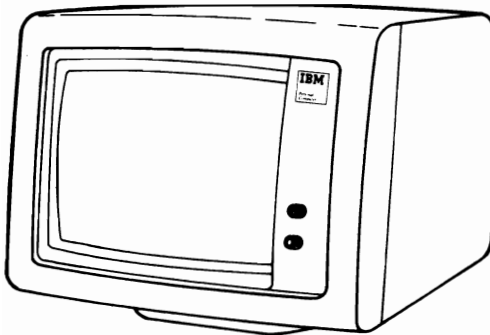

IBM Monochrome
Display

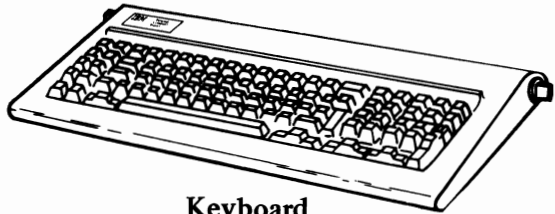

Keyboard

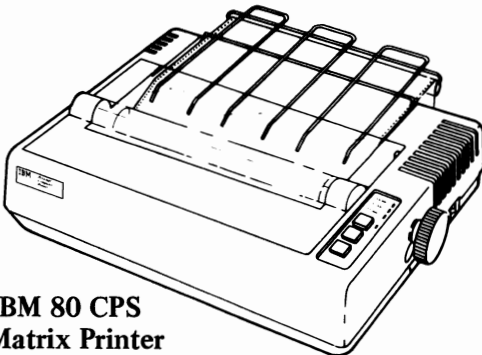

IBM 80 CPS
Matrix Printer

Long Distance Relocate for System Unit

Use all packing materials (corner braces, foam cushions, etc.). Pack in original cartons if available.

Note: If using different cartons, cushion well to avoid damage.

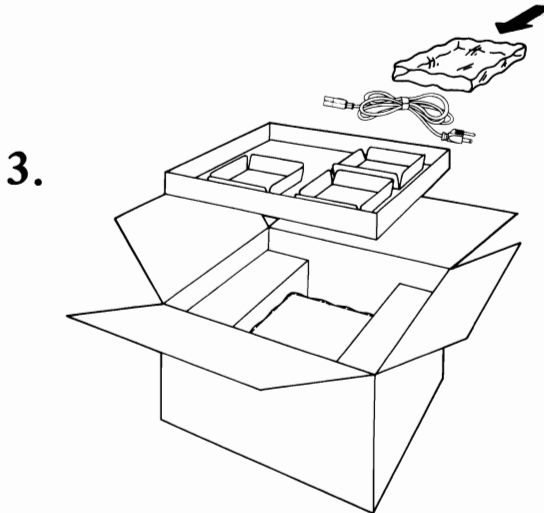
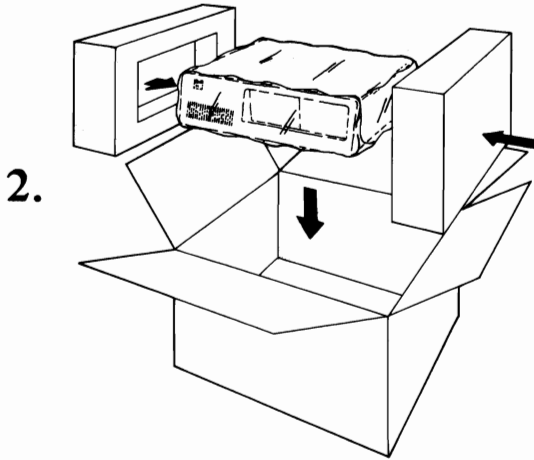

Long Distance Relocate for Keyboard

Use all packing materials (corner braces, foam cushions, etc.). Pack in original cartons if available.

Note: If using different cartons, cushion well to avoid damage.

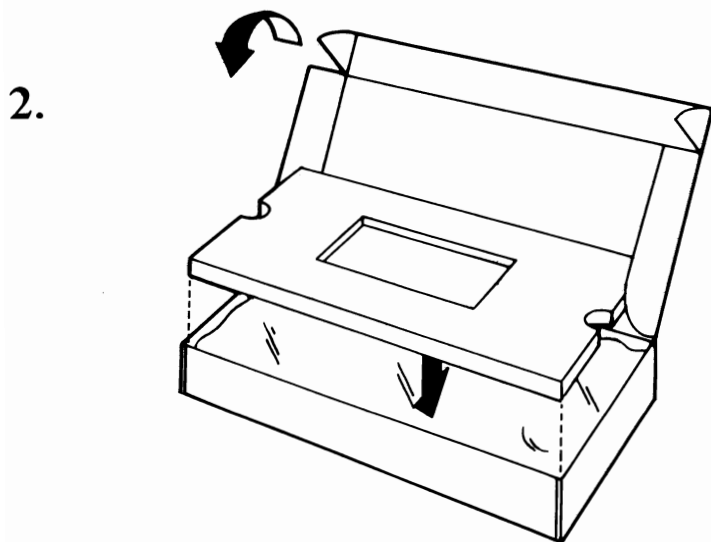
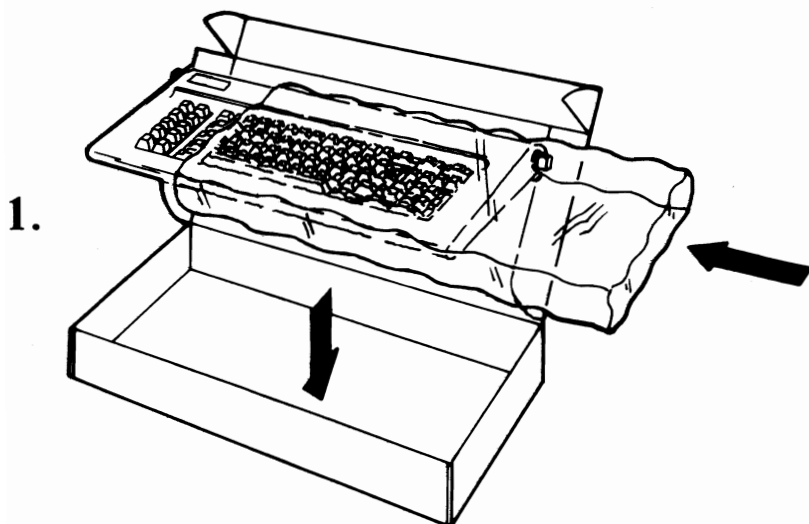

Long Distance Relocate for IBM Monochrome Display

Use all packing materials (corner braces, foam cushions, etc.). Pack in original cartons if available.

Note: If using different cartons, cushion well to avoid damage.

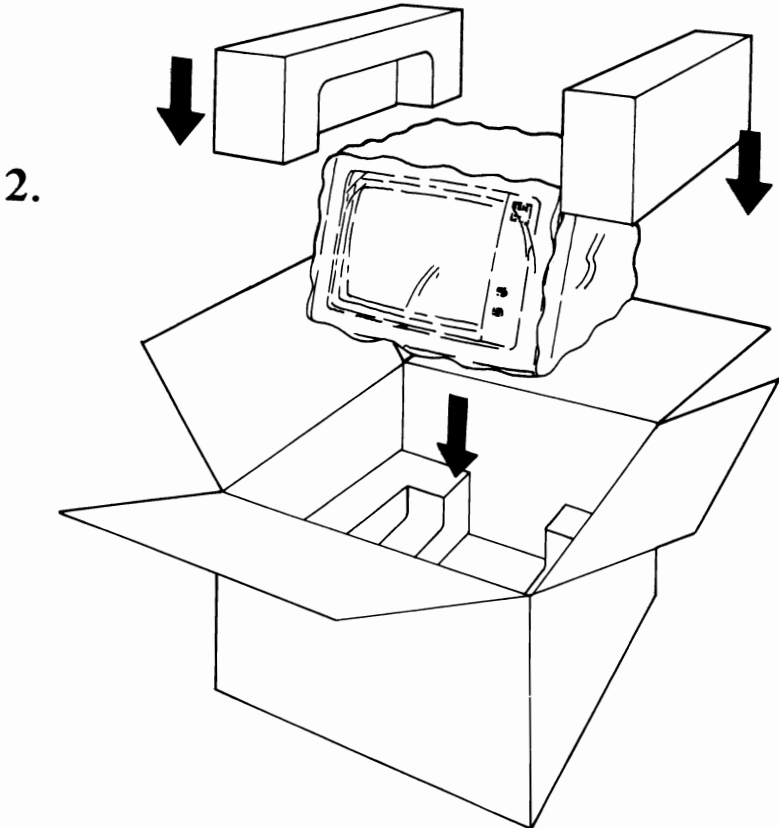
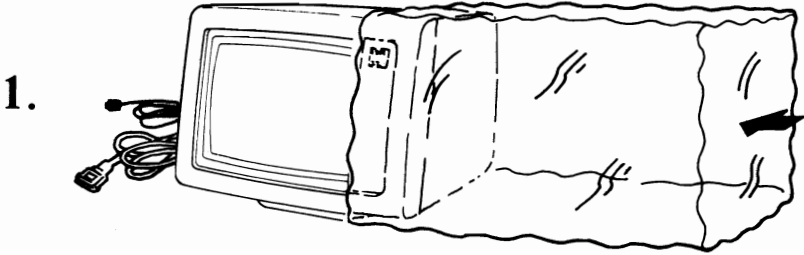

Long Distance Relocate for IBM 80 CPS Matrix Printer

Use all packing materials (corner braces, foam cushions, etc.). Pack in original cartons if available.

Note: If using different cartons, cushion well to avoid damage.

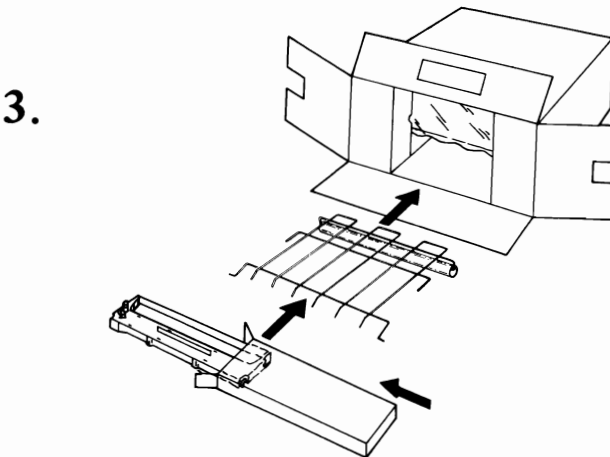
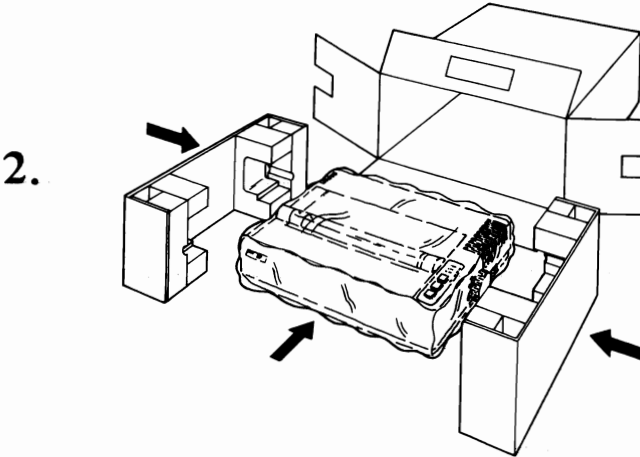
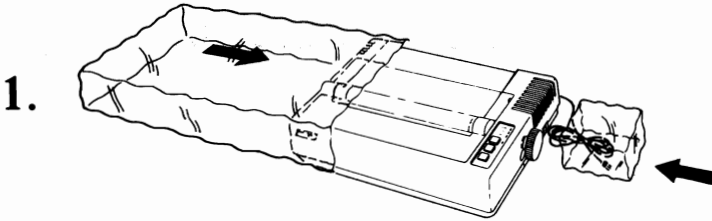

Setup At New Location

When your system arrives at the new location, carefully unpack the System.

For setting up and cabling your Personal Computer, refer to the Instructions in **Section 2. "Setup."**

IBM recommends whenever you recable your system you should perform system checkout. This procedure is titled **Section 4. "Problem Determination Procedures."**

Notes:

Product Comment Form

GUIDE TO OPERATIONS

6025003

Your comments assist us in improving our products. IBM may use and distribute any of the information you supply in anyway it believes appropriate without incurring any obligation whatever. You may, of course, continue to use the information you supply.

Comments:

If you wish a reply, provide your name and address in this space.

Name _____

Address _____

City _____ State _____

Zip Code _____

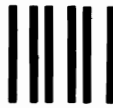

NO POSTAGE
NECESSARY
IF MAILED
IN THE
UNITED STATES

BUSINESS REPLY MAIL
FIRST CLASS PERMIT NO. 123 BOCA RATON, FLORIDA 33432

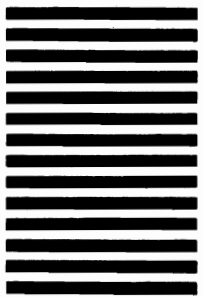

POSTAGE WILL BE PAID BY ADDRESSEE

IBM PERSONAL COMPUTER
SALES & SERVICE
P.O. BOX 1328-C
BOCA RATON, FLORIDA 33432

Fold here

Tape

Please do not staple

Tape