

SOTA 386si  
Installation Guide  
And User's Manual



SOTA Technology, Inc.  
559 Weddell Drive  
Sunnyvale, CA 94089  
Tel: (408) 745-1111  
Fax: (408) 745-1640



SOTA Technology Inc.

# **SOTA 386si**

## **High Performance Accelerator**

**Revision date : 1/31/90**

***SOTA Technology Incorporated***

*559 Weddell Drive*

*Sunnyvale, CA 94089*

***State Of The Art Technology***

Tel: 408-745-1111

*FAX: 408-745-1640*

FAX: 408-745-0537 (International)

*BBS: 408-745-0326*

*TLX: 798674 SOTA USA*

---

## FOREWARD

---

---

### Limitation of Liability

---

SOTA Technology Inc. warrants the SOTA 386si against defects of materials and workmanship, and will repair or replace defective parts within the five year warranty period. Under no circumstances shall SOTA Technology Inc. be liable in any way to the user for damages, including any lost profits, lost savings or other incidental or consequential damages arising out of the use of, or inability to use the SOTA 386si. Information in this document is subject to change without notice.

Copyright 1987, 1988, 1989 SOTA Technology Inc. No portion of this manual may be reprinted in whole or in part without written permission from SOTA Technology, Incorporated.

---

### FCC Compliance Statement

---

This equipment has been certified to comply with the limits for a Class B computing device, pursuant to Subpart J of Part 15 of FCC Rules. Only peripherals certified to comply with the Class B limits may be operating with this equipment. Using non-certified equipment will likely result in interference to radio and TV reception. If this equipment does cause interference to radio or TV reception, the user is encouraged to try to correct the interference by one or more of the following measures:

- Re-orient the receiving antenna
- Relocate the computer with respect to the receiver
- Move the computer into a different outlet so that the computer and receiver are on different branch circuits

If necessary, the user should consult the dealer or an experienced radio/TV technician for additional suggestions. The user may find the following booklet prepared by the Federal Communications Commission helpful: "*How to Identify and Resolve Radio-TV Interference Problems*". This booklet is available from the U.S. Government Printing Office, Washington DC 20402. Stock No. 004-000-00345-4.

---

### SOTA Technology Software License Agreement

---

SOTA Technology, Inc. (SOTA) grants you, the "licensee", permission to use the SOTA 386si software (SOFTWARE) subject to the following terms and conditions:

---

#### Ownership and Copyright of the Software

Although the diskette containing the software is yours, the software is merely licensed to you and remains the copyrighted property of SOTA. This License grants you permission to use the software only as long as you adhere to the conditions of this License.

---

#### Using, Copying, and Altering the Software

You may only use the SOFTWARE on a computer that has the SOTA 386si installed. Any copies of the SOFTWARE are subject to the same conditions as the original provided to you by SOTA. The software may only be used as provided and may not be altered in any way.

---

#### Disclaimer of Software Warranty

The SOFTWARE is provided "**as is**" without warranty of any kind, either expressed or implied, including, but not limited to the implied warranties of merchantability and fitness for a particular purpose. The entire risk as to the quality and performance of the SOFTWARE is with you. Some states do not allow the exclusion of implied warranties, so the above exclusion may not apply to you. You may

have other legal rights which may vary from state to state. In no event shall SOTA be held responsible for incidental, special or consequential damages. SOTA is also not responsible for lost data or profits to you or to any other person or entity at may be incurred through the use of this software, even if we have been advised of the possibility of such damage.

Notes

**IMPORTANT  
README.DOC FILE**

At press time this manual supplied all the features available for the SOTA 386si. As the product develops and new features are added it will be necessary for you to read the README.DOC files located on the distribution diskettes supplied with the 386si. These readme files will supply you with current updates on all the latest features of the 386si.

IBM®, IBM PC®, IBM PC/XT®, IBM PC/AT®, IBM PS/2® and IBM PC DOS® are registered trademarks of International Business Machines Corporation.

TURBO SIDEKICK® is a registered trademark of BORLAND International.

Zenith® is a trademark of Zenith Business Machines, Inc.

Compaq® Portable and DeskPro are trademarks of Compaq Corporation.

Professional ORACLE® is a trademark of Oracle Corporation.

All other product names are trademarks or registered trademarks of their respective manufacturers or publishers.

*Table of Contents*

**FOREWARD . . . . . i**

Limitation of Liability . . . . . i

FCC Compliance Statement . . . . . i

SOTA Technology Software License Agreement . . . . . ii

Ownership and Copyright of the Software . . . . . ii

Using, Copying, and Altering the Software . . . . . ii

Disclaimer of Software Warranty . . . . . ii

Notes: . . . . . iii

**INTRODUCTION . . . . . 1**

PRODUCT OVERVIEW . . . . . 1

PRODUCT DESCRIPTION . . . . . 1

WHAT YOU GET (PACKAGE CONTENTS) . . . . . 2

SYSTEM REQUIREMENTS . . . . . 3

Hardware . . . . . 3

Power Consumption . . . . . 3

**HARDWARE INSTALLATION . . . . . 4**

COVER REMOVAL . . . . . 5

IBM PC\XT and Close Compatibles . . . . . 5

AT&T 6300 and Olivetti PC . . . . . 6

AMSTRAD PC . . . . . 7

COMPAQ PORTABLE . . . . . 7

PS/2 Model 25 and Model 30 . . . . . 7

RELOCATE 8088/8086 FROM MOTHERBOARD TO SOTA 386si . . . . . 7

    AT&T 6300 and Olivetti chip location . . . . . 8

    Zenith PC chip location . . . . . 8

    Chip Extraction . . . . . 8

    REMOVE 8087 . . . . . 10

    INSTALL THE RIBBON CABLE . . . . . 10

        AT&T 6300 and Olivetti PC . . . . . 11

        ZENITH PC . . . . . 12

        . . . . . 12

        PS/2 Model 25 and Model 30 . . . . . 13

    INSTALL 80387SX ON THE SOTA 386si . . . . . 13

        AMSTRAD PC . . . . . 13

    Insert The SOTA 386si . . . . . 15

    Attach Ribbon Cable to SOTA 386si . . . . . 16

        AMSTRAD PC . . . . . 16

        AT&T 6300 and Olivetti PC . . . . . 16

        REPLACE COVER . . . . . 16

**GENERAL OPERATION . . . . . 17**

    BOOTING UP . . . . . 17

    HARDWARE THEORY OF OPERATION . . . . . 18

        MICROPROCESSORS: 8088/8086/-VS- 80386SX . . . . . 18

        MEMORY CACHING . . . . . 19

**SOFTWARE INSTALLATION . . . . . 21**

    SOTA 386si Driver . . . . . 21

        SOTA 386si Driver Options . . . . . 22

        /CACHEOFF . . . . . 22

/CACHEHD . . . . . 23

/KEY=nn . . . . . 23

/NOVIDEO . . . . . 23

/NOBIOS . . . . . 23

/PRINT . . . . . 24

/NOTEST . . . . . 24

/NODMA . . . . . 24

/NOEMS . . . . . 24

/TOP=nnn . . . . . 24

THE CONFIGURATION PROGRAM - 386si.COM . . . . . 25

    CONFIGURATION PROGRAM OPTIONS . . . . . 25

        /CACHEOFF . . . . . 25

        /CACHEON . . . . . 25

        /CACHEHD . . . . . 25

        /NOVIDEO . . . . . 26

        /VIDEO . . . . . 26

        /NOHD . . . . . 26

        /NOBIOS . . . . . 26

        /BIOS . . . . . 26

        /KEY=nn . . . . . 27

        /REVEC . . . . . 27

    RAM DISK DRIVER - SOTADISK.SYS . . . . . 27

        RAM DISK DRIVER OPTIONS: . . . . . 28

            /EMS=nnnn . . . . . 28

            /DOS=nnn . . . . . 29

    DISKCACHE PROGRAM SOTACACH.COM . . . . . 29

        DISK CACHE OPTIONS: . . . . . 30

            /HARD=nnnn ON . . . . . 30

            /HARD=nnnn OFF . . . . . 30

            /FLUSH=nnnn . . . . . 30

            /FLOPPY=nnnn ON . . . . . 31

/FLOPPY= n n n n OFF ..... 31  
 /EMS= nnnn ..... 31  
 /DOS= nnn ..... 31  
 /TIMEOUT= nnn ..... 31  
 PRINT SPOOLER - SOTASPL.COM ..... 32  
 PRINT SPOOLER OPTIONS: ..... 34  
 SOFTWARE THEORY OF OPERATION ..... 34  
 RAM DISK ..... 35  
 DISK CACHE ..... 35  
 PRINT SPOOLER ..... 36  
 CONCLUSION ..... 37

**APPENDICES ..... 38**

APPENDIX A - TROUBLE SHOOTING ..... 38  
 APPENDIX B - JUMPER SETTINGS ..... 41  
 STANDARD CONFIGURATIONS (CPU) ..... 42  
 STANDARD CONFIGURATIONS (80387SX) ..... 43  
 STANDARD CONFIGURATIONS (cache size ) ..... 45  
 APPENDIX C - TECHNICAL SUPPORT ..... 46  
 APPENDIX D - SOTA BULLETIN BOARD ..... 47  
 Downloading Procedure ..... 47  
 APPENDIX E - SOTA PRODUCTS ..... 49  
 SOTA FLOPPY I/O PLUS ..... 49  
 SOTA VGA/16 ..... 49  
 SOTA Memory/16i ..... 50  
 SOTA 340i ..... 50  
 SOTA POP ..... 51  
 APPENDIX F - FOREIGN INSTALLATION ..... 52  
 APPENDIX G - BIOS COMPATIBILITY ..... 53

**INTRODUCTION**

**PRODUCT OVERVIEW**

Congratulations for purchasing the SOTA 386si! Through a short installation process, you can now convert your 8088 or 8086 based computer to an 386 class computer. In addition to instantly improving your system's performance, you have the flexibility to expand in the future.

Your new SOTA 386si represents the state of the art in PC enhancements. Not just another accelerator card, the SOTA 386si is the foundation for a complete integrated solution. Available soon (**see APPENDIX E**) for the SOTA 386si, is the Memory/16i option which allows you to run programs that use extended memory such as IBM OS/2, VDISK.SYS, Professional ORACLE DBMS, Micro Focus Cobol Compiler and others.

The SOTA 386si does not replace your hard disk with the faster AT style disks. It does, however, include software which brings your disk performance to speeds rivaling that of an AT. Other included software lets you set up RAM disks, a print spooler and other utilities.

We hope you find the SOTA 386si the best enhancement you have ever purchased. In using the SOTA 386si, you can feel comfortable that you have saved your previous hardware and software investments and your system will remain compatible with future state of the art hardware and software.

**PRODUCT DESCRIPTION**

The SOTA 386si is an add-on card that plugs into your IBM PC or compatible and boosts its performance well beyond that of an IBM PC/AT. The primary design goal of the SOTA 386si is to provide you with the fastest accelerator board available at a reasonable cost.

Installation is fairly easy and involves removing your 8088/8086 from your PC motherboard and plugging it into the socket provided on the SOTA 386si. A cable is then inserted into the empty 8088/8086 socket on the motherboard and connected to its proper location on the SOTA 386si.

When running in the 386 mode all I/O is done by using the existing I/O chips on the motherboard. This is accomplished by a proprietary VLSI bus converter that converts the 16 bit data bus of the 80386SX chip into the 8 or 16 bit data bus on the motherboard. The bus converter also synchronizes the fast 386 with the slow 8088/8086 I/O.

---

**WHAT YOU GET (PACKAGE CONTENTS)**

---

SOTA 386si  
Ribbon cable  
Installation Guide and User's Manual  
Warranty registration form  
Chip extraction tool  
80387SX Math Coprocessor (optional)  
SOTA utility diskette with:  
SOTA 386si driver  
RAM disk  
Disk cache  
Print spooler

---

**SYSTEM REQUIREMENTS**

---

**Hardware**

IBM PS/2 Model 25, Model 30, PC, XT, Compaq Portable or DeskPro, AT&T 6300 PC, Olivetti PC, Amstrad PC, Leading Edge PC, Zenith PC or most 8088/8086 based compatibles, with 64 Kb memory (minimum) and a 5 1/4 or 3 1/2 inch floppy disk drive.

**Power Consumption**

Be sure that your system provides an adequate power supply for the cards you have installed. The SOTA 386si requires the following current from the +5V supply:

- 1.00 Amps with no 80387SX
- 1.25 Amps with 80387SX

The 386si is a very power efficient add-on and requires approximately 5 Watts.

## HARDWARE INSTALLATION

**IMPORTANT:** Prior to beginning installation, you should configure the SOTA 386si for the machine in which it is to be installed. In many cases, if the machine was specified at the time of ordering, the SOTA 386si will be configured at the factory for that computer. Default setting is for a standard IBM PC, XT, and most 8088 compatibles. If you are installing in a different machine, then you may have to alter the jumper selection of the board. Refer to Appendix B and C for the correct jumper placement. It is a good idea to check your configuration with the appendix regardless of the machine.

It is a good idea to check the readme.doc file on your SOTA utility diskette for any current updates, this may be done using the TYPE command (ie. **TYPE README.DOC**). If you have never installed option cards in your computer, refer to your computer's **GUIDE TO OPERATIONS** as you use this manual. Before you start you will need a medium-sized flat headed screw driver and the chip extraction tool which is included in the SOTA 386si carton. Carefully perform the following steps in the order they are presented.

The **AT&T 6300, Olivetti PC, IBM PS/2 Model 25 and Model 30, Compaq Deskpro and Amstrad PC** all use 8086 microprocessors. If you are installing the 386si into one of these computers, you should refer to Appendix B for the correct configuration of the SOTA 386si. If you are not certain which microprocessor your system uses, consult with your local dealer.

## COVER REMOVAL

### IBM PC\XT and Close Compatibles

The following instructions assume that you have an IBM PC, XT, or close compatible. If not, your computer may require a different procedure for the cover removal. Since it isn't possible to document every machine here, we have given special instructions for only a select few. In most cases, your computer's **Guide To Operations** will explain the cover removal.

- Turn off the power to your computer and all peripherals.
- Unplug all power cords from the wall socket.
- Disconnect all cables from the rear of the computer.
- Mark the cables if you are not sure you will remember where to reattach them later.
- Remove the five screws on the back of the computer chassis. See Figure 1.
- Slide the cover towards you until it can go no further then tilt the cover upward and away from the frame. See Figure 2.

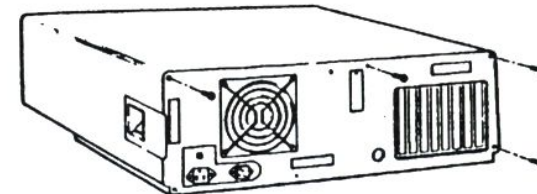

Figure 1



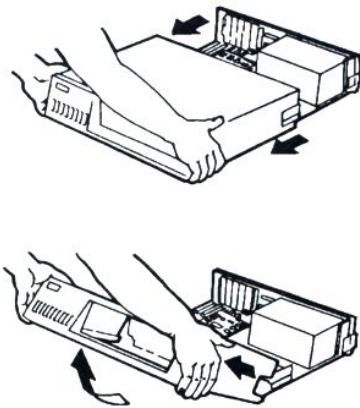

Figure 2

#### AT&T 6300 and Olivetti PC

To remove an AT&T 6300 and Olivetti PC cover, do the following :

- Remove all cables from the rear of the computer.
- Turn the computer so its back is facing you.
- Remove the screws from the upper left and right hand corners. **You can now remove the top cover.**
- Remove the screws from the bottom left and right hand corners. **You can now lift the unit away from the bottom plate.**
- Turn the unit on its right side (**the floppy drive(s) will be at the bottom facing you**).
- Turn the unit so the internals are facing you and locate the screws on the upper left and right hand corners. **These screws secure the side panel and must be removed.**
- The final two screws are located at the bottom of the side plate (**in between the side plate**

and the video board). Remove these screws and lift the side plate off.

- You are now ready for the installation of the SOTA 386si.

#### AMSTRAD PC

With the machine facing you, put pressure on the corners of the cover closest to you and slide it away from the machine.

#### COMPAQ PORTABLE

Refer to Amstrad for cover removal. You will also have to remove the top sheet metal plate covering the expansion cavity in order to gain access to the expansion slots.

#### PS/2 Model 25 and Model 30

There are four screws on either side of the machine, remove these and the cover will lift off.

Carefully slide (horizontally) the cover off the chassis.

#### RELOCATE 8088/8086 FROM MOTHERBOARD TO SOTA 386si

In order to remove the 8088/8086 chip you might need to pull an expansion board or two in order to get to the chip location. You can identify the 8088/8086 chip by the imprinting on the back of the chip, it is one of the larger chips on the board and most manufacturers put the 8088/8086 socket and 8087 sockets side by side.

Please note that there are several versions of the 8088 chip (ie. 8088-1, 8088-2 and the compatible NEC V-20) they are all compatible with the SOTA 386si. The same is true for the 8086 chip (8086-1, 8086-2 and NEC V-30). You must note the location of the 8088/8086 socket as it looks identical to the 8087 socket and it may be

difficult to distinguish the two. Before removing the 8086/8088, you must identify Pin 1 and mark its position on the printed circuit board. Pin 1 on the chip is identified on the chip as being at the end with the notch or a small dot at the left-hand upper corner. It is important to note where the notch or dot on the 8088/8086 was when you removed the chip, so that you can orient pin 1 correctly. The manufacturer's printed circuit marking is not always sufficient, as some PC's CPU boards may be marked incorrectly.

The 8088/8086 processor chip location is fairly obvious on most computers, but owners of AT&T 6300s, Olivetti PCs, or Zenith PCs might become confused. Read the following if you own one of these computers.

#### AT&T 6300 and Olivetti chip location

The Motherboard is positioned on the bottom of the AT&T 6300 and Olivetti PC's. If you read the previous section on cover removal then all that is needed to locate the 8086 processor is to turn the computer around so the internals are facing away from you. The 8086 chip is located in the center of the motherboard. **Look for the socket location labeled 3J.**

#### Zenith PC chip location

The Zenith PC's (back plane system) 8088 processor is located on a removable board. The board can be identified by locating where the keyboard plugs into the back of the system. The board which it plugs into holds the 8088 processor. You can then locate the 8088 at the bottom of this board about half way from the back of the computer.

#### Chip Extraction

Using the chip extraction tool, gently pry up both ends of the 8088/8086 chip. Then grasp the 8088/8086 microprocessor firmly with your fingers (using equal force on both

ends of the chip) and remove it from its socket. Try **NOT** to touch the pins of the chip - only the plastic/ceramic package.

Be careful not to insert the chip puller between the socket and the motherboard, this may damage your computer. The chip puller must be inserted between the 8088/8086 CPU and the socket itself. If for any reason (as in some imported PC look-alikes) the 8088/8086 chip is soldered into the board of your PC, have your personal computer dealer/serviceman remove the original CPU and install the SOTA 386si, as this removal must be done carefully.

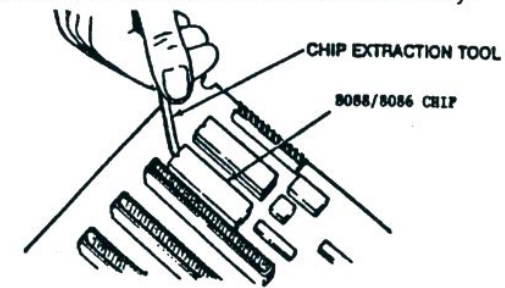

Make sure that you do not bend any pins on the 8088/8086 chip. If you do, then gently straighten them out. You can use your fingers, but a pair of needle nose pliers will work much better.

Take the chip you just removed and plug it into the 8088/8086 socket on the SOTA 386si (the empty socket is on the top right of the card, beneath the ribbon cable connector). The notch on the 8088/8086 must face the right side of the card, which is the end with the bracket and toggle switch. Do not orient the 8088's pin 1 by the notation on your PC's printed circuit board, as some models have been known to have incorrect printing on the CPU board. Use extra caution when lining the pins up with the socket before you press down on the chip.

**REMOVE 8087**

If you have an 8087 math coprocessor, you should remove it the same way you removed the 8088/8086 (see above).

Remove the small styrofoam guard attached to the end of the ribbon cable and, for storage, insert the the 8087 into the piece of styrofoam. You can then store the 8087 chip for future use.

Make sure the second position on the first 8-position dip switch in an IBM PC (or the only DIP switch in an IBM XT) corresponds with the absence of the 8087 math coprocessor. It should be ON if the 8087 is absent.

The 8087 switch settings (position 2) may conflict with those shown in some versions of IBM's *Guide To Operations*. The settings stated above are correct. Early versions of IBM manuals were printed with these settings reversed.

***If you wish to install the 386si in an AT&T 6300, then DIP switch 0, position 5, should be on. This will ensure the appropriate settings for the use of the 386si with or without the 80387SX installed.***

**INSTALL THE RIBBON CABLE**

**IMPORTANT:** *Read this section thoroughly before proceeding with the installation of the ribbon cable.*

Please note that since the SOTA 386si supports many different machines, the installation of the ribbon cable is slightly different for each machine.

Insert the ribbon cable into the empty socket where you just removed the 8088/8086 chip on the motherboard. The red stripe on the ribbon cable (the red color on the ribbon indicates the Pin 1 position of the ribbon) must align with Pin 1 of the 8088/8086 socket.

Some computers other than the IBM PC/XT may have the 8088/8086 socket facing a different direction other than the rear of the computer. You must identify Pin 1 and align it

with the red stripe on the cable. Pin 1 on the chip was at the end with the notch at the end or a small dot at the left-hand upper corner. It is important to mark where the notch or dot on the 8088/8086 was when you removed the chip so that you can orient pin 1 correctly. The printed circuit marking is **not** always sufficient, as some models of personal computers have CPU boards which are marked incorrectly.

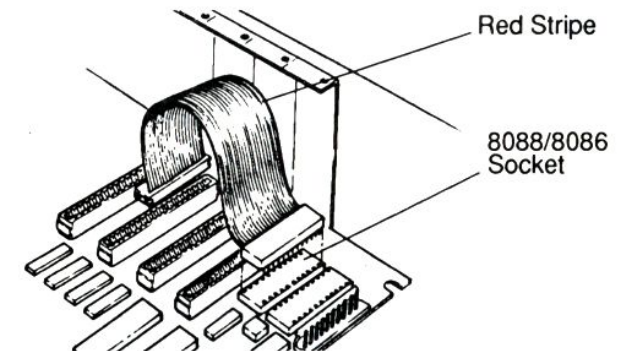

**IMPORTANT : DO NOT INSERT THE RIBBON CABLE BACKWARDS! THIS WILL MOST LIKELY BURN THE CABLE AND POSSIBLY CAUSE OTHER DAMAGE TO THE SOTA 386si OR YOUR SYSTEM!**

**AT&T 6300 and Olivetti PC**

If you are installing the SOTA 386si in an AT&T 6300 or Olivetti PC it is necessary to use a 24 inch cable **and not the 14 inch cable** standard with the SOTA 386si. If you do not have this cable, consult your local SOTA authorized dealer. Also, this cable is in an "L" shape oriented toward the rear of the machine.

With the left side plate removed, install the cable in the 8086 socket, and insert the cable through the opening between your chassis and the video adapter. Run the cable

next to the video adapter over the top of your machine and place it inside the center of your machine.

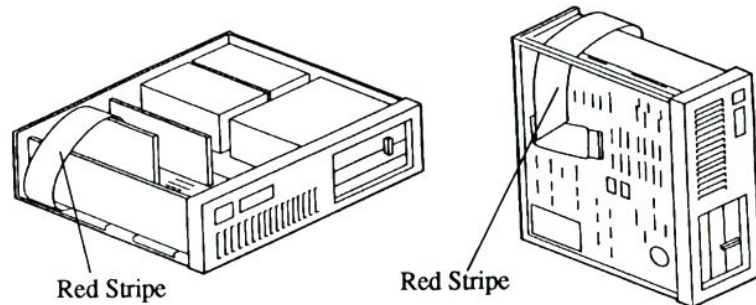

### ZENITH PC

The Zenith PC, as mentioned earlier, is a back plane system where the processor is located on a removable board. This board was removed earlier to access the 8088 processor chip. Plug the cable into the 8088 socket and fold the cable underneath the board so when the board is replaced in the computer the length of the cable is on the opposite side of the 8088 socket.

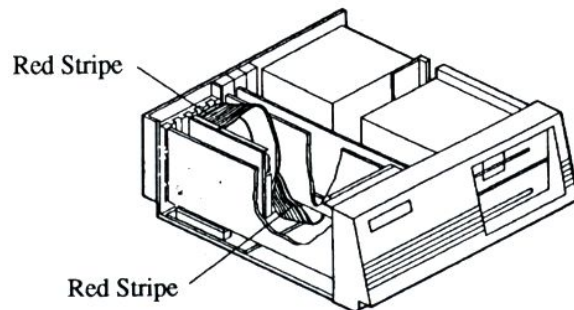

### PS/2 Model 25 and Model 30

Plug the cable onto the motherboard so the red ribbon side is towards the power supply. Run the cable underneath the crossbar and insert the other end onto the 386si. The 386si will probably need to be in the first (upper) slot.

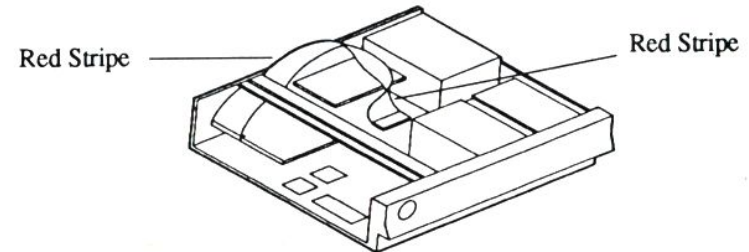

### INSTALL 80387SX ON THE SOTA 386si

If you do not have the 80387SX option then skip this step. Otherwise, insert the 80387SX math coprocessor chip in its empty socket on the SOTA 386si (the 80387SX socket is located near the bottom left corner of the SOTA 386si)

### AMSTRAD PC

In installing the 386si in the Amstrad 1640PC, the cable **must** be placed with pin 1 (red stripe) at pin 1 of the socket on your motherboard. **The 386si must be installed in the slot which is the third slot from the back of the 1640, and the twist in the cable must be as close as possible to the 386si header.**

Use extra care when lining the pins up with the socket before you press down on the DIP plug which is the head of the ribbon cable. Improper pin alignment is one of the most common installation problems. Note the figure below for the location of the 80387SX socket.

**IMPORTANT:** Note the small dot (dimple) on the 80387SX chip. Insert the chip in the indicated socket with the dot pointing to the right. If you look at the 80387SX socket you will note the number 2 printed on the bottom right corner of the socket wall. The dot on the 80387SX chip should coincide with this corner.

**NOTE:** Do not change the DIP switch setting on your motherboard for the 8087, the 80387SX on the SOTA 386si will be automatically recognized by 386si.SYS driver.

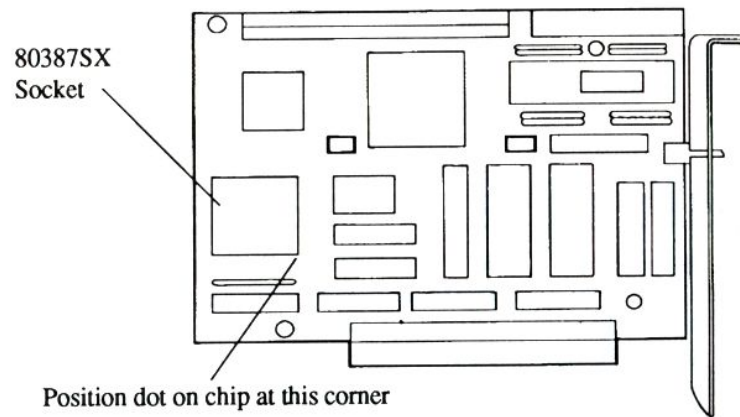

### Insert The SOTA 386si

Select an unused expansion slot for the SOTA 386si. **Do NOT put the SOTA 386si next to your video display board or network board, due to excessive noise generation by video boards.** Avoid putting the video display card or other high frequency (noisy) adapter between the SOTA 386si and the 8088/8086 socket. It may cause cross-talk problems with the ribbon cable of the SOTA 386si and create unpredictable difficulties. We recommend that you install the SOTA 386si as close to the 8088/8086 socket on your motherboard as possible. When you have selected the slot, remove the metal slot cover in the rear of the chassis by unscrewing the retaining screw. Save this screw to secure the SOTA 386si in the following step.

Using both hands, grasp each end of the SOTA 386si and, using even pressure, push the card's gold finger connectors straight down into the expansion slot. Be sure that you have inserted the card completely and securely into the slot. Replace the screw that secures the metal bracket to the chassis.

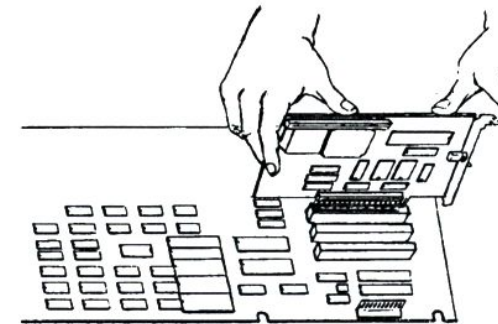

### Attach Ribbon Cable to SOTA 386si

Connect the unattached end of the ribbon cable to the proper place on the SOTA 386si. The red stripe on the ribbon cable must align with the bracket side of the board containing the toggle switch. Make sure all the pins are properly connected.

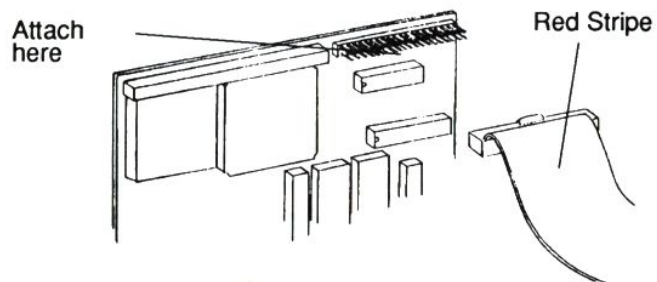

### AMSTRAD PC

If you are installing the SOTA 386si in an Amstrad 1640 PC then you must attach the cable with the red stripe near the metal bracket. This will require a twist of the cable but it should not damage the cable.

Reinstall any expansion boards that you took out to get at the 8088/8086 and 8087 chips.

### AT&T 6300 and Olivetti PC

You should put the side plate on first then the bottom plate and finally the cover.

Reattach all the cables to their appropriate connectors. The hardware installation is now finished.

### REPLACE COVER

Slide the cover back on your computer, and reverse the cover removal procedure for your computer.

## GENERAL OPERATION

### BOOTING UP

Hardware installation is now complete and you are ready to turn on your computer. Please note that there are two modes that the computer can operate in, native (8088/8086), and 80386SX mode. Selection of these modes is determined by a toggle switch which protrudes through the metal edge connector of the SOTA 386si. In the up position, native mode is selected and in the down position 80386SX mode is used. The SOTA 386si does not support native mode in every machine (**Compaq DeskPro computers rarely boot in native (8086) mode**). This is due, in part, to the strength and age of your 8088/8086 chip, and the fact that the 386si is compatible with a wide range of machines. The object is to support 80386SX mode on every machine and a software method of speed selection which will be discussed later. Native mode will be supported on most machines; however, its presence or absence should not be of concern as virtually all software will run at the faster speed. Additionally, if a timing problem does occur then you may keyboard select the slower speed (see software section).

First, toggle the switch on the SOTA 386si to the down position and turn on your system. Your system should automatically reset and reboot in 80386SX mode. Even though it will be in 80386SX mode, it will still operate slowly due to the absence of memory caching. Proceed to the next section to enable high speed operation of the SOTA 386si.

### GOING FROM SLOW MODE TO FAST AND BACK AGAIN

By following the above section, you can toggle between 8088/8086 and 80386SX mode using a hardware toggle switch. This switch, located at the back of the card, both selects the indicated processor and reboots your com-

puter. If you move the switch to the up position, you will be in native (8088/8086) mode; and with the switch down, 80386SX mode. Even when you run in the 80386SX mode, the SOTA 386si does not operate at maximum throughput. This is because the 16 KB memory caching feature available on the board is turned off. Therefore, although the 80386SX runs at a high clock speed, it still depends on the slow 8088/8086 bus to supply its data.

To fully utilize the high speed of the SOTA 386si, you must enable the memory caching with either the SOTA 386si software driver (), or the special hardware method discussed in Appendix B - Jumper Settings. In 99% of all cases, the software driver is the method of choice. The only time you should use the hardware method is if you are running an operating system (not MS or PC-DOS) which does not support loadable device drivers. For instructions on installation of the software driver, see the section on Software Installation. After booting up with the driver installed, you should experience a dramatic speed improvement. Now the SOTA 386si not only runs your software with a fast 80386SX microprocessor, but also runs with 0 wait states on most memory accesses. You can type <Alt-Ctl-Num5> to switch between fast and slow mode.

## **HARDWARE THEORY OF OPERATION**

### **MICROPROCESSORS: 8088/8086/-VS- 80386SX**

The single most important chip in a personal computer is the microprocessor (or CPU). The 8088/8086 and the 80386SX are all microprocessors from INTEL. The 8088 chip is the microprocessor in the PC/XT class machines, the 8086 CPU is used in the PS/2 Model 30 and AT&T 6300 while the 80386SX is the microprocessor in the PC/AT class machines.

The 8088 chip has an 8 bit data bus while the 8086 and 80386SX have 16 bit busses. This means that every time the 8086 or 80386SX microprocessors read from or write

to memory they do so with 2 bytes instead of one. This makes them more efficient than the 8088. Additionally, the 80386SX has a faster clock speed and a shorter bus cycle than either the 8088 or 8086. As a result, the 80386SX can process up to 10 times faster than the 8088/8086.

Essentially the 80386SX is a superset of the 8088/8086 processors. It can operate in 2 different modes, the real address mode and the protected mode. The real address mode operates almost exactly like an 8088/8086 except that it is up to ten times faster, based on internal improvements and maximum obtainable clock frequency.

In real address mode, the 80386SX is object code compatible with existing 8088/8086 software. Essentially, this means that an 80386SX computer like the IBM PC/AT can run software written for an 8088/8086 based computer such as the IBM PC. Until now, most IBM PC/AT's were being used in real address mode because there was limited software available that supported an 80386SX running in protected mode. With the recent release of OS/2, a new operating system that uses protected mode, this is no longer the case. More and more, software developers are now writing programs that take advantage of the advanced features of the 80386SX. With the Memory/16i installed, the SOTA 386si supports these features.

### **MEMORY CACHING**

In order to maximize processor operating speed while using relatively slow memory chips, hardware designers have developed a system of "caching" RAM or ROM memory accesses so that a processor can actually operate faster than the memory it uses. The SOTA 386si includes a hardware memory cache which can actually let the 386si's processor run at full speed most of the time even while using a PC, XT or other computer's slow 8 or 16 bit memory!

This cache system, built into the proprietary VLSI of the SOTA 386si, works under two basic assumptions. First,

that most memory reads will take place on memory which has either recently been read or written. Second, that when a memory write occurs, the processor does not need to wait for the information to actually get stored in the slow RAM chips before it does something else. Since these assumptions are generally true, most memory reads can be cached and almost all memory writes can occur at 0 wait state speed.

To understand why memory reads typically take place on recently accessed memory, it is helpful to realize that most programs contain small "loops" which execute the majority of the time the program is running. In addition, data variables contained within programs are almost always accessed fairly often during the execution of the program. Other helpful factors include the constant location of BIOS and DOS routines which are also sped significantly by memory caching. These factors combine to let caching significantly speed memory reads by the CPU. Of course, when the CPU must read memory which is not cached, it slows down to accommodate the slow memory, but the next time it reads memory from the same address, the read will most likely take place at full speed from the cache.

Perhaps an even more interesting feature of the cache is the way that it caches memory writes or "write buffers" RAM memory. Basically when the 80386SX CPU writes to a memory location, the cache hardware signals to the 80386SX processor that the write has completed even before the information reaches the slower RAM. While this may seem strange, remember that the cache handles both writes and reads. Therefore, if the CPU tries to read information which has not yet reached the slower memory chips, it will read the information from the high speed hardware cache, again reaping benefit and operating at full speed.

Since the cache contains a limited amount of high-speed memory, when data is cached, it must replace previous data which was in the cache. Therefore, the benefit of the

cache levels out after a short time to provide an average percentage of cached memory access versus access of slow memory not in the cache. This percentage is commonly referred to as the cache "hit rate". The advanced cache of the SOTA 386si provides an amazing 95% hit rate with average system use.

---

## SOFTWARE INSTALLATION

---

### SOTA 386si Driver

---

The SOTA 386si includes a software driver labeled 386si.sys. This DOS device driver automatically enables the high speed caching features of the SOTA 386si and enables keyboard speed switching between fast and slow operating modes and ensures compatibility with EEMS or EMS 4.0.

In addition to providing overall speed enhancement, this driver also allows you to selectively speed up portions of your system operation for maximum speed and compatibility. With simple parameters, you can control whether or not the system BIOS, hard disk BIOS, or video BIOS is cached by the 0 wait state memory cache. All of these features and others can be changed "on the fly" by the program 386si.COM which is documented below.

Normally, you can simply install the driver in your CONFIG.SYS file and let it speed up your system automatically. At times, however, you may decide to slow down your system to run games or certain timing-dependent software. To do this, simply type Alt-Ctl-5 (Num5 is the key on the numerical key pad) which will bring the speed to about the same as before the SOTA 386si was installed. You can return to high speed operation simply by pressing Alt-Ctl-5 again. After installing the driver for the first time, you may want to try switching back and forth to get a feel for how it operates.



Since 386si.SYS is a device driver, you must reference it in your CONFIG.SYS file before it will have any effect. It is usually a good idea to install it as the first device in your CONFIG.SYS file. To install 386si.SYS do the following:

Copy 386si.SYS to the directory of your choice.

If you do not have a CONFIG.SYS file, create one with the following commands:

- **COPY CON CONFIG.SYS**  
**FILES = 30**  
**BUFFERS = 20**  
**DEVICE = [path]386si.SYS**  
**PRESS F6 Function key**  
**PRESS <Enter>**

If you do have a CONFIG.SYS file, add the following line to it as the first statement:

**DEVICE = [path]386si.SYS**

Reboot your computer to enable the new configuration. That's all there is to it! You can now use the keystroke combination described above to switch between fast and slow operation.

### SOTA 386si Driver Options

Usually, the default configuration of the driver will work best. We have added some options which you may want to use. To enable any of these options, just add them to the line in your CONFIG.SYS file which references 386si.SYS. There must be at least one space before each slash ("/"). The available options are as follows:

#### /CACHEOFF

386si.SYS normally turns the high speed cache on at the time it is installed. This parameter turns the cache off to provide compatibility with a small number of speed-dependent device drivers.

#### /CACHEHD

Usually, caching the hard disk BIOS can cause problems because of timing sensitive loops which may fail when run at a faster speed. For this reason, 386si.SYS defaults to not caching the hard disk BIOS. If you are sure that your hard disk BIOS will work at a high speed and you want to override this setting, use the CACHEHD parameter and the hard disk BIOS will be cached.

#### /KEY=nn

If you want to change the speed switching toggle key, you can set it to another key by using the scan code nn in this parameter. You must use the scan code value which is generated by the hardware in order for this to work properly. Refer to your computer's manual for the scan code or run the SCANCODE program provided on the SOTA 386si Utilities software diskette.

#### /NOVIDEO

386si.SYS normally enables high speed caching on video RAM which can dramatically speed the screen display. With almost all MDA, CGA, EGA, or VGA cards this should never cause a problem. If, however, you happen to experience garbled graphics screens, you may need to disable this feature. The NOVIDEO parameter simply prevents 386si.SYS from caching video memory.

#### /NOBIOS

This parameter completely disables the caching of the system BIOS. Normally, 386si.SYS enables caching on the system BIOS which speeds many operations. It also automatically disables the caching whenever a program accesses the floppy disk. Because of this smart approach to caching, you probably do not need to use this parameter. If however, you run into problems when caching the system BIOS, you can use this parameter to disable it altogether.

/PRINT

This parameter is provided for those systems that experience problems with parallel printing. If your printer does not respond or only prints portions of the data sent then add **/PRINT=ON to the Device = 386si.SYS line in your config.sys file.**

/NOTEST

This parameter prevents 386si.SYS from testing the cache RAM. This is only necessary on very few compatibles, notably the Zenith series of XT compatibles. If this parameter is necessary and is not used, the computer may hang immediately after 386si.SYS displays its sign-on message.

/NODMA

This parameter causes the 386si.SYS driver to disable caching of Direct Memory Accesses. This parameter should be used with Zenith personal computers.

/NOEMS

This option sets the driver to work with the add-on board made by PMI called the "PMI Aboveboard." This option is available on 386si.SYS versions 1.14 and later.

/TOP=nnn

This option sets the top of DOS memory. It will allow for base memory increases of 704K, 720K, or 736K bytes. If a software application such as DESQview or Omniview expands the DOS address space above 640K using available EMS then the TOP option should be used. The reason behind this is due to the fact that the 386si.SYS driver does not automatically cache this memory above 640K, which may result in noticeable speed degradation. The TOP option will restore the high speed performance. **This option is available on 386si.SYS versions 1.21 and later.**

**EXAMPLE:**

**DEVICE = \SOTA\386si.SYS /CACHEHD /KEY=53**

**The above line will install the cache control software and cache all of the standard memory regions as well as the hard disk BIOS. It also change the speed switching key to Ctl-Alt-/ (Forward Slash).**

THE CONFIGURATION PROGRAM - 386si.COM

The SOTA 386si configuration program lets you change all of the 386si.SYS device driver parameters after you have booted your system and loaded the device driver itself. This means you can enable or disable the cache, change speed switching hot keys, or selectively enable and disable certain caching features.

To use 386si.COM, simply make sure that it is in your current path and that you have loaded 386si.SYS as described in the previous pages. Then you can enter the following command.

**386si [options]**

CONFIGURATION PROGRAM OPTIONS/CACHEOFF

This parameter disables the system cache if it is currently on and has no effect if it is currently disabled.

/CACHEON

This parameter enables the system cache. Neither **/CACHEON** nor **/CACHEOFF** affect the state of what other parts of the system are actually cached. For example, if video caching is enabled, you can enable and disable the cache as many times as you like, but when the cache is enabled, video caching will remain active.

/CACHEHD

Usually, caching the hard disk BIOS can cause problems because of timing sensitive loops which may fail when run

at a faster speed. For this reason, 386si.SYS defaults to not caching the hard disk BIOS. If you are sure that your hard disk BIOS will work at a high speed and you want to enable hard disk caching, you can do so by running 386si.COM with the /CACHEHD parameter.

#### /NOVIDEO

386si.SYS normally enables high speed caching on video RAM, this speeds up the screen display. If you experience garbled graphics screens in certain applications, 386si.COM allows you to disable the video caching with this parameter. You can then re-enable it with the /VIDEO parameter after you have left the offending application.

#### /VIDEO

If you have initialized 386si.SYS with the /NOVIDEO parameter or temporarily disabled video caching, this parameter allows you to to reenable it at any time.

#### /NOHD

This parameter lets you disable caching of the hard disk if you have enabled it. Remember that if you disable hard disk caching with this parameter, a /CACHEHD parameter in your CONFIG.SYS file after 386si.SYS will still re-enable hard disk caching after you reboot.

#### /NOBIOS

This parameter completely disables the caching of the system BIOS. You can always re-enable it by running 386si.COM with the /BIOS option described below.

#### /BIOS

This parameter re-enables system BIOS caching after it has been disabled.

#### /KEY=nn

If you want to change the speed switching toggle key, you can set it to another key at any time by using the scan code nn in this parameter. You must use the scan code value which is generated by the hardware in order for this to work properly. Refer to your computer's manual for the scan code or run the SCANCODE program provided on the SOTA 386si Utilities software diskette.

#### /REVEC

If you use an international keyboard driver which loads after DOS boots up, you will lose the capability to switch back and forth between fast and slow mode with the keyboard. To remedy this, we have provided the "/REVEC" switch. Simply run 386si.COM immediately after you load the international keyboard driver and use the "/REVEC" option. You will then regain all of the standard keyboard features of the 386si driver software. Lastly, make sure that if you are using SideKick, not to use the "/REVEC" option after SideKick is resident.

### RAM DISK DRIVER - SOTADISK.SYS

The RAM disk driver included with your SOTA 386si provides the ability to set aside a portion of RAM and treat it as if it were disk space. This can help in speeding up programs which use overlays from disk, or use the disk often.

When you install the SOTA RAM disk driver, DOS will recognize a new drive letter just after the last drive you had before installation. For example, if you had drives A, B, and C, when you install the RAM disk driver, it will actually create a new drive D. The new drive will actually be RAM and will operate much faster than any of the mechanical drives. However, when you turn off or reboot your computer, the information stored on the RAM disk drive will disappear. Therefore, you should not store important data

on RAM disks. Instead, you should use them for storing information that may be accessed quite often, but probably won't change. For more information on RAM disks, see the SOFTWARE THEORY OF OPERATION section.

The RAM disk driver, SOTADISK.SYS, supports both conventional and expanded memory. To use expanded memory, you must either have an expanded memory board or the SOTA Memory/16i option and its software driver. To install SOTADISK, do the following:

Make sure that an EMS driver is installed if you plan to use EMS.

Copy SOTADISK.SYS to the directory of your choice.

Add the following line to your CONFIG.SYS file, don't forget to specify the path name:

- **DEVICE=[path]\SOTADISK.SYS [/DOS=nnn]  
[EMS=nnn]**

If you want to use EMS memory for the RAM DISK, make sure that the above line is after the line containing the EMS driver in the CONFIG.SYS file. The [ ] indicate options (you can use either DOS or EMS memory or both).

Reboot the computer to activate the new configuration. SOTADISK will create a new RAM disk.

#### **RAM DISK DRIVER OPTIONS:**

To alter the configuration of the SOTADISK, you may select the parameters it uses by adding the following options to the line containing the SOTADISK.SYS driver in the CONFIG.SYS file:

##### **/EMS=nnnn**

Set the amount of LIM Expanded Memory to use, nnn specifies the number of KB to use.

##### **/DOS=nnn**

Set the amount of DOS memory to use, the parameter nnn specifies the number of KB to use.

nnn specifies the amount of memory in kilobytes and will be rounded up to the nearest 16KB block. If the options are used, the total of all numbers determines the RAM disk size.

##### **EXAMPLE:**

**DEVICE=C:\SOTADISK.SYS /DOS=16**

The above line will install SOTADISK with 16 KB of DOS memory.

#### **DISKCACHE PROGRAM SOTACACH.COM**

Similar to the RAM disk driver, the disk caching utility helps to speed up programs which use the disk often. Unlike the RAM disk, it is completely transparent to the user, and does not lose data when the computer is turned off, rebooted or you suffer a power failure. In fact, the only disadvantage it has compared to the RAM disk driver is that it uses the mechanical disk when it needs to.

You can run the disk caching program, SOTACACH.COM, from either the DOS command line or your AUTOEXEC.BAT file. Do not put it in your CONFIG.SYS file since it is not a DOS device driver.

SOTACACH supports both conventional and expanded memory. To use expanded memory, you must either have an expanded memory board or the SOTA Memory/16i option and its software driver installed. To install SOTACACH, do the following:

If you want to use EMS memory, make sure that an EMS driver is installed in your CONFIG.SYS file.

Copy SOTACACH.COM to the directory of your choice.

Make sure that you add the directory where SOTACACH.COM is located to your system path before trying to run SOTACACH.

Examine the options below and determine what options you want to use when installing the cache.

Add the following line to your AUTOEXEC.BAT file:

#### **SOTACACH [options]**

This command and its corresponding options may be entered in your AUTOEXEC.BAT or just by typing them in at the DOS prompt.

#### **DISK CACHE OPTIONS:**

To alter the configuration of the SOTACACH you may select the parameters it uses by adding the following options to the AUTOEXEC.BAT or just by typing them in when you enter the command:

##### **/HARD= n n n n ON**

Activate caching on the specified hard disk. The disk is specified as a physical number. ie: 1 is the first hard disk, 2 is the second hard disk.

**NOTE: This option is only necessary if you desire to cache specific hard disks. If you want to cache all hard disks then the following is sufficient:**

**SOTACACH /DOS= nnnn**

##### **/HARD= n n n n OFF**

Deactivate caching on the specified hard disk. The disk is specified as a physical number. ie: 1 is the first hard disk, 2 is the second hard disk. If no disk is specified then all hard disks are affected.

##### **/FLUSH= n n n n**

Flush data from cache for the specified hard disk. If no disk is specified then all hard disks are affected. If you have the

removeable hard disk such as Bernolli Box you should flush the disk cache everytime you change the cartridge.

##### **/FLOPPY= n n n n ON**

Activate caching on the specified floppy drive. The drive is specified as a physical number. ie: 1 is the first floppy drive, 2 is the second floppy drive. If no drive is specified then all floppy drives are affected.

##### **/FLOPPY= n n n n OFF**

Deactivate caching on the specified floppy drive. The drive is specified as a physical number. ie: 1 is the first floppy drive, 2 is the second floppy drive. If no drive is specified then all floppy drives are affected.

##### **/EMS= nnnn**

Set the amount of LIM Expanded Memory to use. nnnn specifies the number of KB to use.

##### **/DOS= nnn**

Set the amount of DOS memory to use. nnn specifies the number of KB to use.

##### **/TIMEOUT= nnn**

- Usage: SOTACACH /TIMEOUT= nnn

where nnn is 55 msec increments.

Example: SOTACACH /TIMEOUT= 36

sets timeout to approximately 2 seconds (DEFAULT).

The /TIMEOUT option controls when floppy disk caching buffers are cleared. This option is usually used for systems that do not have hard disk drives, and must use floppy disk drives to run application software. Most accesses of the floppy disk drive occur within 2 seconds of each other in a given task, so the default value of 2 seconds is adequate

in most instances. It also takes at least 2 seconds to change a floppy diskette, so the default value automatically flushes the the floppy cache before another diskette can be accessed.

If disk intensive applications are being run and the diskette is never changed, you may use a /TIMEOUT value of "0". Then the floppy cache will never flush and RAM speeds can be approached on disk accesses.

The floppy disk cache (if set) must be flushed whenever the diskettes are changed. Anytime the floppy disk drive is accessed the drive mechanism is turned on, which is rather slow, so instead of checking the physical device for media (diskette) changes, automatic cache flushing is employed.

#### EXAMPLE:

**SOTACACH /DOS=16 /EMS=112**

The above line will install SOTACACH with 16K bytes to DOS memory, 112K bytes allocated to EMS memory. All hard disks will be cached and no floppy drives will be cached.

**NOTE: You can set these SOTACACH options in the autoexec.bat file or from the command line, but remember that once the /DOS and /EMS options are set you can not re-initialize them without re-booting the system. All other parameters can be re-initialized without a re-boot.**

### PRINT SPOOLER - SOTASPL.COM

No matter how fast your computer runs, it often has to slow down to print. Since the printer can only print at its rated speed, the computer spends a lot of its time waiting for the printer to accept the next character. With the SOTA print spooling program, you can send data to a RAM buffer very quickly, then return to work while the spooler feeds data to the printer for it to print at its maximum speed.

You can run the print spooling program, SOTASPL.COM, from either the DOS command line or your AUTOEXEC.BAT file. As with the disk caching program, it will not operate properly if installed in the CONFIG.SYS file.

SOTASPL.COM supports both conventional and expanded memory. To use expanded memory, you must either have an expanded memory board or the SOTA Memory/16i option and its software driver installed. To install SOTASPL.COM, do the following:

If you want to use EMS memory, make sure that an EMS driver is installed in your CONFIG.SYS file.

Copy SOTASPL.COM to the directory of your choice.

Make sure that you add the directory where SOTASPL.COM is located to your system path before trying to run SOTASPL.

Examine the options below and determine what options you want to use when installing the cache.

Add the following line to your AUTOEXEC.BAT file:

**SOTASPL [options]**

#### PRINT SPOOLER OPTIONS:

To alter the configuration of SOTASPL.COM, you may select the options available by adding the following parameters to the AUTOEXEC.BAT or just by typing them in when you run SOTASPL.COM.

/LP= n	n is the printer number to specify (1 or 2)
/DOS=nnn	nnn is the number, in K-bytes, of DOS memory to use.
/EMS=nnnn	nnnn is the number, in K-bytes, of EMS memory to use.
/SOTA=nnn	nnn is the number, in K-bytes, of SOTA memory to use.

- `/TAB=nnn` nnn is the number of the column position of each tab.
- `/LEFT=nnn` nnn is the column position of the left margin.
- `/RIGHT=nnn` nnn is the number of columns in a line.
- `/PAGE=nnn` The number of lines on a printed page.
- `/BREAK=nn` nnnn is the column where the lines end on a page.
- `/NOINT` specifies the printer hardware interrupt.
- `/INT=nnn` nnn is a specific IRQ line to use with the printer.

By default, LPT1: is spooled using both the printer and timer interrupts. For example:

```
SOTASPL /DOS=16
```

The above line will install SOTASPL with 16k bytes of DOS memory allocated. The parallel printer will be spooled.

## SOFTWARE THEORY OF OPERATION

In addition to the high performance hardware, each SOTA 386si includes SOTA Productivity software which takes advantage of its unique features. The following productivity software comes standard with the SOTA 386si package:

- *Ram Disk*
- *Disk Cache*
- *Print Spooler*

To familiarize you with how each program works we will cover the theory of operation in the next few pages.

## RAM DISK

RAM DISK is also called VIRTUAL DISK or DISK EMULATION. The RAM Disk software that comes with your SOTA 386si lets you use some memory (RAM) as though it were a disk drive. Unlike an ordinary disk drive, a RAM Disk has no mechanical parts, so it works much faster. As a result, it speeds up the access of your data.

Once the RAM disk has been created, you can COPY to it, COPY from it, ERASE files from it or run any other DOS commands with it. However, because RAM disk is a device driver, it must be setup in your CONFIG.SYS file, and all the data will disappear when ever you reboot or turn off the computer.

A RAM disk is especially useful with application programs that frequently access overlays, libraries or temporary files. You can tell how often a program accesses a disk drive by watching the drive lights go on and off. When a disk drive's lights come on, the computer is accessing (reading from or writing to) the disk.

When running a program, if you notice the disk drive light flashing often, you could probably speed up that program by using a RAM disk to replace the conventional drive. If you write new data files on a RAM disk, realize that the files could be destroyed if a power failure occurs. So, you should copy your new data files from the RAM disk to your hard disk or floppy diskette FREQUENTLY, and you should not write any important data files to the RAM disk.

If you keep the differences between RAM disk and magnetic disk in mind, you can safely use a RAM disk to speed up your application programs.

## DISK CACHE

Disk cache is a program that essentially speeds up disk activities (floppy & hard disk). Disk cache is similar to RAM disk in many ways. They are similar in that they both speed

up disk access, but disk cache is more advanced than RAM disk because it speeds up your program automatically without user intervention.

Disk cache reserves RAM (conventional or EMS) as buffers to hold copies of data from the disk. Every time an application reads the disk, the cache program first looks in the buffer to see if it already has the requested data. If it does, then it eliminates the disk read which makes your application run faster. Each time there is a disk read that is not in the buffer, a disk access occurs and the buffer is gradually filled. When the buffer is full and a disk read is required that is not in the buffer, it discards the least recently used data to make room for the new data.

The copies of the sectors are held in sequence according to frequency of usage. Every time a sector is read, it is placed at the top of the list. As a result, heavily used sectors such as the directories, indices to a random file or your word processor's overlays are automatically held in memory, providing dynamic optimization that is independent of the application. In conclusion, disk access time is cut dramatically without any user intervention.

### PRINT SPOOLER

The print spooler is a piece of software that lets you print a document without tying up your computer. While your documents print, you can continue working.

When you work at your computer, it can be annoying to stop, send a document to the printer, then wait for the printer to finish before you go back to what you were doing. Though most programs are capable of transferring documents very quickly, most printers receive data slowly.

A print spooler solves this problem by turning some of your computer memory into a data buffer. Data pours in from the application program to the memory, stands in memory until the printer is ready for it, then flows to the printer at a rate the printer can handle.

Your application programs can work faster when they send data to memory because the memory, unlike the printer, can accept data rapidly. With a print spooler, your computer is free for other work as soon as the printer buffer (memory) has been filled. While you go on working, the data waits in memory until the printer is ready for it. The print spooler never interferes with you or your program.

### CONCLUSION

SOTA Productivity software provides you with many features which can help in your day to day computer use as well as ensure compatibility with your existing hardware and software. All of the programs have been designed to be easy to use and efficient in their operation. Although using a RAM disk, disk cache and print spooler can improve the performance of your computer at no cost, it involves one big tradeoff: the memory set aside for these programs can severely impact the limited 640K of DOS memory.



---

## APPENDICES

---



---

### APPENDIX A - TROUBLE SHOOTING

---

**SYMPTOM:** No Screen Display or the computer does not turn on under native (8088/8086) mode (i.e., when the toggle switch is thrown upward).

**ACTION:** Make sure that your monitor is plugged into your computer and all power cords are connected. Is the 8088/8086 installed correctly on the SOTA 386si (see section in manual)? Check the SOTA 386si cable installation. One of the most common installation problems is bending a pin or not getting all the pins in the socket. Move the SOTA 386si to a different slot. The one you used may not have good solid connection with the board.

**SYMPTOM:** No screen display or the computer beeps when running at 80386SX mode (i.e., with the toggle switch thrown downward).

**ACTION:** Refer to Appendix B and double check to make sure the SOTA 386si is configured properly. Please note that the configuration differences between 8088 and 8086 machines requires not only the proper jumper settings but also the proper placement of the 74LS646 chip at location U17 and U18. If all settings are correct, toggle the switch upward (native mode) and wait until system boots completely, then toggle the switch downward to 80386SX mode.

**SYMPTOM:** System freezes while loading the SOTA 386si cache driver in your CONFIG.SYS file with a ZENITH model computer.

**ACTION:** Check to see if the /NOTEST parameter has been specified after the SOTA 386si cache driver (i.e., DEVICE= 386si.SYS /NOTEST). Please check with the README.DOC file in the SOTA 386si Utility Diskette.

**SYMPTOM:** The EMS memory in your system is not being recognized or accessible by the program.

**ACTION:** Make sure the SOTA 386si cache driver gets loaded before the EMS driver in your CONFIG.SYS file.

**SYMPTOM:** System freezes or key board locks after booting up under 80386SX mode.

**ACTION:** If you are booting up with an AUTOEXEC.BAT file, try to rename it first, then reboot the system to determine if any statement in the AUTOEXEC.BAT may be conflicting with the board. If removing or renaming the file solves the problem, try to determine which statement is causing the conflict.

**SYMPTOM:** My Zenith 151, 158 or 159 found to fail to boot correctly - gives **Timer Interrupt Failure**.

**ACTION:** The version of the PROM manufactured in 1987 or later (versions -5, -6, -16 and later) will work best. See Appendix F for compatibility information, and contact your dealer for the revision.

**ACTION:** A hardware fix was necessary in order for the 386si to function properly in Zenith computers. Check to see if your 386si has this fix. You should see a capacitor attached to the back face of the 386si along with a wire connecting 2 points. If you do not see this fix then contact SOTA Technology.

**SYMPTOM:** My AMSTRAD will not boot to floppy - get non system disk error.

**ACTION:** Make sure your 386si has the **AMSTRAD fix**. The fix consists of a resistor added to the back of the 386si, at the bottom, near the gold connectors and one near the middle of the board. If your board does not have this fix then contact SOTA Technology Inc..

**SYMPTOM:** Cannot boot the system when **Tall Tree JRAM 3 Card** is installed (memory conflicts).

**ACTION:** Change the memory location the JRAM card writes to from block F to block E.

**SYMPTOM:** My turbo (4.77MHz-10MHz) system will not boot to the 80386SX mode.

**ACTION:** Boot the system in the 4.77MHz mode.

**SYMPTOM:** System reports **NMI Error**.

**ACTION:** Disable the Autoswitching EGA/VGA feature of your graphics board.

**SYMPTOM:** My 5-slot IBM PC does not boot.

**ACTION:** Move the toggle switch up and down one or two times, and this should allow the machine to boot. The original IBM PC made in 1981 and 1982 is an older machine that requires this switching up and down (or turning the machine off and on) to boot properly. This is not a defect in the board, but a result of that host environment.

**ACTION:** Remove (or place onto one pin) the jumper that covers the first set of pins on the JP5 jumper block. (See page 43).

**SYMPTOM :** During boot-up the error message **1801** appears. **ACTION:** You ordinarily want the 386si to be positioned in the second or third slot from the 8088/8086 socket on the motherboard. This error occurs when the 386si is too close to the power supply which indicates the 386si is in the first slot. If this error occurs then move the 386si to another slot in your computer - the second slot would be fine.

**SYMPTOM:** During boot-up the message Cache Ram Fail appears.

**ACTION:** This could be caused by loose or damaged **Static Ram**. The static ram chips are located in the sockets labeled U11, U12, and U16. These chips are below the large square chip labeled SOTA and consist of 2 larger chips and 1 thinner chip. Carefully remove these chips and reseal them in the sockets. If this fails contact SOTA's technical support department.

**SYMPTOM:** My IBM 3270 does not function properly.

**ACTION:** Contact SOTA Technology Inc. for solution.

## APPENDIX B - JUMPER SETTINGS

There are two jumper blocks on the SOTA 386si, marked by JP2 and JP5. JP2 is for selecting the system configuration (8088 or 8086), cache control, and the amount of cache memory installed. JP5 is set according to the presence of (or not) an 80387SX math coprocessor chip.

There are also two sockets, U17 and U18, for the 7N4LS646NT IC. The 7N4LS646NT IC should be in the **U17 socket for the 8088** class computers, and in **U18 for the 8086** class computers. While one of the sockets is occupied, the other one should remain empty.

Here is an illustration of the board, the jumper blocks, and IC sockets which you can configure. The figure below indicates the standard 8088 based system jumper configuration.

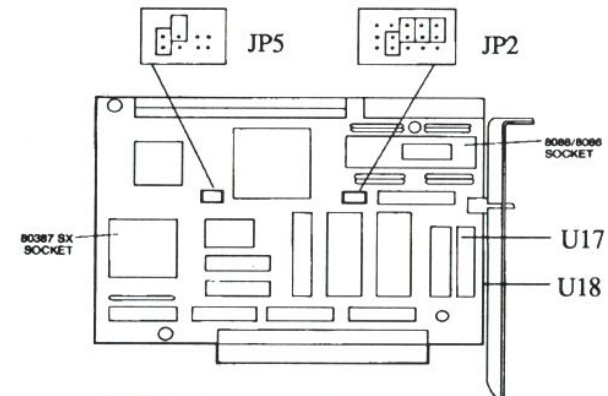

**Important: READ the following 2 pages carefully! Page 42 provides the standard jumper settings for the JP2 jumper block for both 8088 and 8086 based computers. It also indicates the proper chip location for the IC chip mentioned above. Page 43 indicates the proper settings for the JP5 jumper block for the optional math coprocessor (80387SX). Pages 44 and 45 discuss various caching options.**

**STANDARD CONFIGURATIONS (CPU)**

All 8088 based machines e.g IBM PC, XT, Compaq Portable, Zenith PC, and most 8088 compatibles.

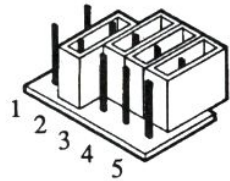

JP2 jumper block

All 8086 based machines e.g IBM PS/2 Model 25, Model 30, Compaq Deskpro, and most 8086 compatibles.

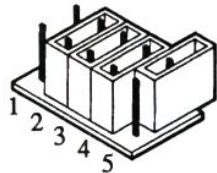

JP2 jumper block

AT&T 6300, Olivetti PC M24, Xerox 6065 and most AT&T 6300 OEMs

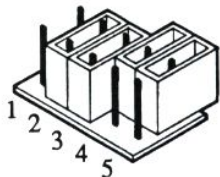

JP2 jumper block

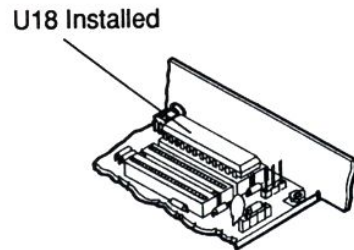
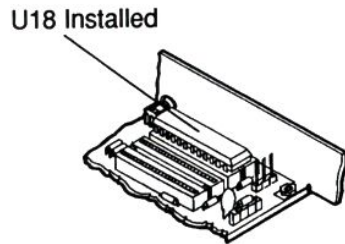
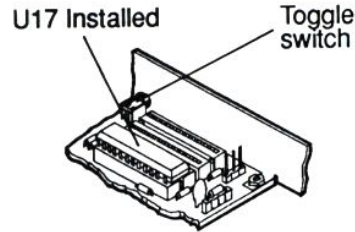

**STANDARD CONFIGURATIONS (80387SX)**

The figures at left indicate the proper jumper settings for the JP5 jumper block to configure the optional math coprocessor (80387SX).

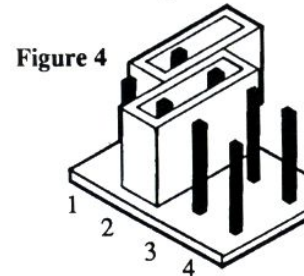
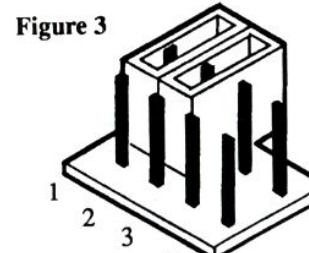
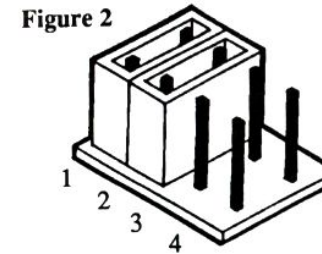
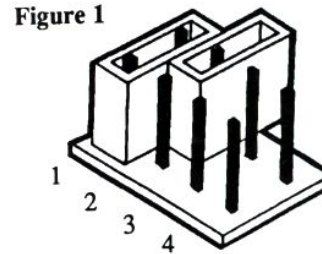

Figure 1 is the factory default setting and implies that no coprocessor is installed on the 386si.

Figure 2 indicates that a 16MHz math coprocessor (80387SX) has been installed on the 386si. Notice that jumper number 2 has been moved onto both pins.

Figure 3 is a special setting for owners of the original 5 slot IBM PC. If you own this computer then jumper 1 should be removed or placed on one pin.

Figure 4 assumes you own an original IBM PC and that a 16MHz math coprocessor (80387SX) is installed on the 386si.

The following jumper settings are included for those users who are **not using** our software driver **386si.sys** and need to enable the caching of the 386si via hardware. The reason this might be necessary is when the 386si is installed in a **diskless workstation** for instance. Again we refer to the JP2 jumper block.

**NOTE: Do not be confused by the fact that the figures below are not exactly like the figures of the JP2 jumper block on page 42. The first two sets of pins on the JP2 jumper block configure for hardware caching. For clarity we have left all other pin sets blank.**

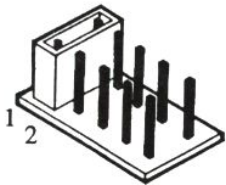

The figure at left would enable hardware caching of the 386si 50 seconds after the computer is turned on. The first set of pins is jumpered and the second set is left blank.

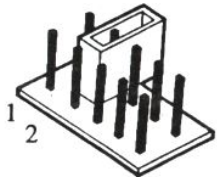

The figure at left would enable hardware caching of the 386si 5 seconds after the computer is turned on. The first two set of pins are left blank. **If a jumper is set on one pin as shown in the figure it is the same as if no pin is there at all.** If you look on page 42 you will note that the default setting is for no hardware caching which means the second set of pins is jumpered and the first set is left blank. If you want the setting at left either remove the jumper completely from the second set of pins or move it on to one pin as shown - this way you would not lose the jumper in case you needed it again.

### STANDARD CONFIGURATIONS (cache size)

The following information indicates what is necessary in order to upgrade the cache size of the 386si from the default cache size of 16K to 64K. The cache on the 386si is referred to as **Static Ram**. Located on the 386si are 3 static ram chips that make up the 16K cache. The chips are located in the chip sockets labeled U11, U12 and U16. These designations are printed on the board itself on the outside of the chip sockets. These chips must be replaced with the following:

- U11 - replace with a 32x8 55nanosecond SRAM.
- U12 - replace with a 32x8 100nanosecond SRAM.
- U16 - replace with a 32x8 100nanosecond SRAM.

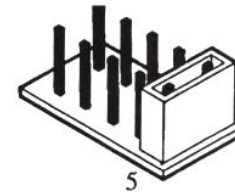

On page 42 you can see that pin set 5's jumper is always positioned on one pin. If you upgrade the static ram cache as explained above then you must jumper the 5th set of pins on the JP2 jumper block as shown at left.

**IMPORTANT: Due to the high "hit rate" of the 386si.sys driver there is little evidence that this upgrade is of any real consequence. At best you might enjoy a 2% performance increase which in most cases would hardly be negligible. If you run extremely "disk intensive" applications then this upgrade might prove useful. In general, however we do not recommend this upgrade considering the realitively high cost of the static ram chips.**

---

**APPENDIX C - TECHNICAL SUPPORT**

---

Before calling SOTA for technical assistance please read the following suggestions of things you yourself can look for in determining your problem. This will save you the time and expense involved in a long distance call to our technical support department.

- Are you sure that you have attached the cable to the 386si and motherboard correctly? Make sure all the pins are inserted and none are bent or broken.
- Have you checked Appendix B in this manual to verify that the jumper settings are correct on the 386si?
- Make sure all power and peripheral cables have been reinstalled on your computer.
- Have you installed the software driver 386si.SYS correctly?

If you could not determine your problem following the above suggestions or if you still have any questions about the SOTA 386si please contact SOTA Technology Inc. and ask for the technical support department. Please have the following information available before calling :

- The make and model of the computer being used.
- A detailed description of the problem.
- If at all possible call when you are at the computer so we can better serve you in a troubleshooting capacity.

Our technical support department will answer your questions Monday through Friday between 8:00 AM and 5:00 PM (PST) at (408) 745-1111.

---

**APPENDIX D - SOTA BULLETIN BOARD**

---

*If you own a modem feel free to take advantage of our BULLETIN BOARD SYSTEM (BBS). You can reach our BBS 24 hours a day at (408) 745-0326. The BBS accepts BAUD rates of 300,1200, and 2400 using the parameters N,8,1(no parity, 8 bit word, 1 stop bit).*

When you first logon to the BBS it will asked you to enter some information for our records i.e. your name, city&state, phone number(home/office),SOTA product you own, as well as a password of your choice. Once you have entered a password the BBS will ask for verification and from then on you will need to enter this password to gain access to the BBS. **Make a note of your password so you do not forget it.**

The BBS will help you keep up on the latest developments at SOTA as well as provide a forum in which you can discuss with other users of SOTA products solutions to problems you might encounter. The BBS also provides access to the latest versions of our product(s) software for downloading.

---

**Downloading Procedure**

---

- At the **Main Board Command** enter **F** (for file directories) then press <Return>.
  - A list of product directories i.e. 286i, 386i etc. will be displayed numbered 1 to n (n being the current number of products available).
- Choose the product directory of your choice.
  - All the file names (utilities and drivers) for the given product will display.
- At the prompt enter **D** for download.

- It will then ask what file you want to download. Enter the file name you want to download and then press <Return>.
- The BBS will then prepare for downloading and will display some information similar to the following.
  - The file to be downloaded.
  - How many bytes the file is.
  - Estimated time to download.
  - Number of blocks to download.
- At this point it will be necessary for you to initiate the downloading procedure of your particular communications package.

The following example is for users of **PROCOMM**:

- When the above information is displayed it is time for you to initiate download.
- Press the <Pg Dn> key on your keyboard.
- Choose number (1) **Xmodem** protocol option.
- It will then prompt you for a file name to download to your system. Choose any file name or simply keep the name we have given the file. Press <Return>.

The file should then begin to download onto your system. When the download is complete press <Return> and continue on with your BBS session.

**NOTE:** Most communication packages will have a similar download procedure.

## APPENDIX E - SOTA PRODUCTS

*The following are additional SOTA products available now and in the future :*

### SOTA FLOPPY I/O PLUS

The **Floppy I/O Plus** is a floppy controller card which comes standard with the following:

Support for up to 4 floppy drives.

Will support any combination of 360K,720K,1.2MB and 1.44MB floppy drives.

Comes standard with 1 serial and 1 parallel port. (second serial port is optional)

Attaches directly to the 286i or can be installed in any standard expansion slot on the motherboard.

### SOTA VGA/16

The **SOTA VGA/16** is a state-of-the-art video adapter that offers features and functionality equal to and beyond any other in the VGA class of graphics boards. The **SOTA VGA/16 features are as follows:**

System level compatibility with the IBM VGA Adapter.

Register-level compatibility with existing EGA/CGA/MDA and Hercules graphics standards.

Graphics resolution modes providing 640x480, 800x600, and 1024x768 High Resolution when used with the appropriate monitor (*A monitor that supports High Resolutions modes*).

Text modes providing 132x25, 132x28,132x44, 100x40, and 80x60 resolutions.

Running extended text modes in Lotus 1-2-3 and Symphony; and extended graphics mode drivers for Auto-

CAD, Digital Research GEM, Microsoft Windows, Ventura Publisher, WordPerfect 5.0 and Framework II.

**SOTA Memory/16i**

The **SOTA Memory/16i** option for the **286i** and **386si** will be available in the early Fourth quarter of 1989 (EARLY October). It will attach to the SOTA 286i or 386si through the local 16 bit connectors standard on these boards. The **SOTA Memory/16i** together with the SOTA 286i and 386si will form one (1) full length board. **Facts are as follows:**

- AT real-time clock for task switching under OS/2.
- AT reconfigurable BIOS stored in static RAM and ROM.
- Memory/16i will use both 256K and 1MB SIMMS.
- Memory/16i will support up to 8MB.
- The memory will be configurable as extended memory (protected mode) for those users wanting to run OS/2 generation programs or EMS 4.0 for those users requiring expanded memory.
- Memory/16i uses "0" wait state RAM.

**SOTA 340i**

For high performance, crystal clear graphics, look to the SOTA 340i intelligent graphics system. Based on the Texas Instruments 34010 graphics system processor (GSP), the 340i provides high resolution and performance. By offloading the host computer of time consuming graphics functions, the 340i exceeds EGA, VGA, and even 8514/A levels of performance. The SOTA 340i supports Texas Instruments Graphics Architecture, the 8514/A Applications Interface, EGA/VGA pass through, and Hercules RAMFont and CGA graphics standards. Resolutions up to and including 1024x768 256 colors and 1280x1024 16 colors will

be possible. Executing up to 6 MIPS with a maximum draw rate of 48 million pixels per second, the SOTA 340i delivers power - redefining performance for graphics applications - running applications like Microsoft Windows at well over 25 times the speed of EGA or VGA adapters. The SOTA 340i is fully compatible with past and present graphics standards. It provides register level emulation of CGA, Hercules, and Hercules RAMFont adapters as well as support for EGA/VGA pass through and the 8514/A interface. The 340i will also support TIGA, the new programming interface standard for 34010 based products. **(Available February 1990).**

**SOTA POP**

SOTA POP, featuring the SOTA Mapper 4.0 EMS memory chip is SOTA's first upgrade product exclusively for the AT 286 machine. It breaks the 640K barrier by providing the 286 user with the ideal memory management solutions that were until now available only in 386 class machines. SOTA POP is a small board that plugs onto your AT motherboard in the 80286 socket. The 80286 chip is then inserted on the SOTA POP and that's it - installation is complete! All that is necessary now is to install the driver software and the memory management power is at your fingertips. You can now load network drivers, DOS, RAM disks and other memory resident programs into high memory. This will free valuable DOS memory for use by large applications such as Ventura Publisher and LOTUS 3.0. By providing full implementation of the LIM EMS 4.0 specification, SOTA POP can support multitasking programs like DESQview, Windows 286, Omniview and Software Carousel. Imagine working in Ventura Publisher while your LOTUS 3.0 spreadsheet recalculates in the background! **(Available February 1990).**

---

## APPENDIX F - FOREIGN INSTALLATION

---

The following instructions apply to boards installed in machines with foreign keyboard installation. You must have SOTA's utility software, version 2.0 or after. To install the foreign keyboard, do the following:

- Step 1 : **LOAD 386sl.SYS**
- Step 2 : **RUN KEYBXX.COM**
- Step 3 : **RUN 386sl /REVEC**

**IMPORTANT** : Do not run **386sl /REVEC** after a memory resident program such as **SIDEKICK** has been installed.

---

## APPENDIX G - BIOS COMPATIBILITY

---

To ensure compatibility with Zenith computers, a BIOS ROM upgrade may be necessary. The following lists the minimum revision level for ROM BIOS upgrades.

Model#	BIOS Part#	BIOS Version	Revision Date
151	444-269-16 & 444-260-16	3.0B	
158	444-358-6 or 444-358-5		7-14-87 2-02-87
159	444-494-5	3.0B	7-14-87

Please specify **DEVICE= 386sl.SYS /NOTEST /NODMA** in the Config.sys file for all Zenith computers.