

SERVICE MANUAL

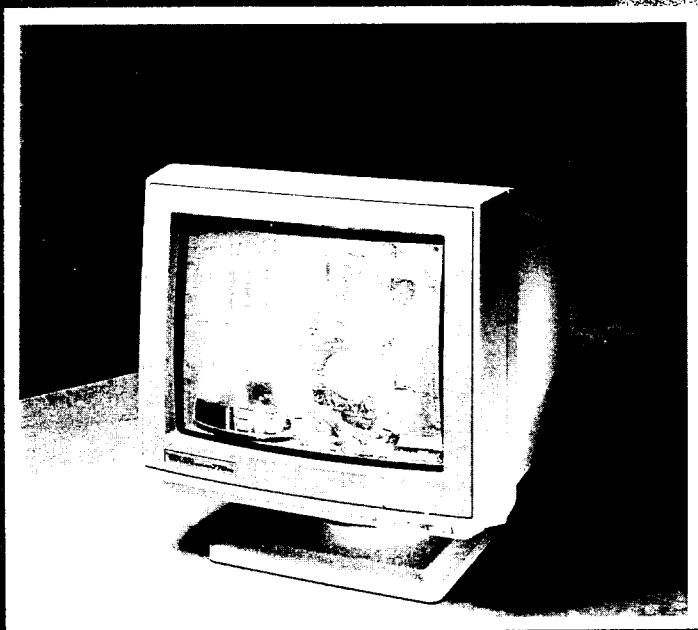

For the Taxan Multivision 770 plus

SERVICE INFORMATION

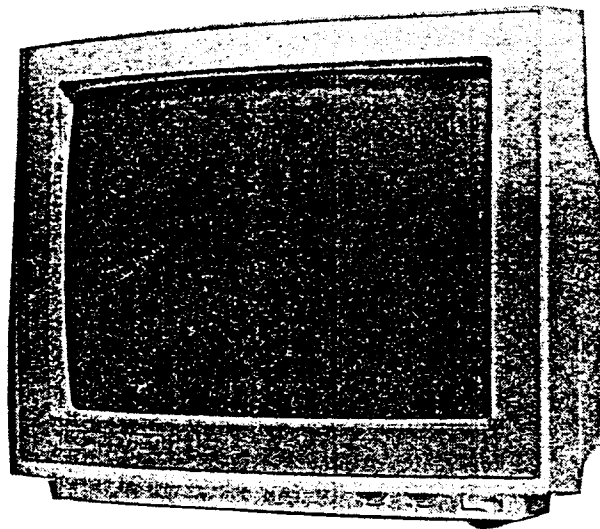

CONTENTS

SPECIFICATION	2~3	SERVICE ADJUSTMENT	11~15
SAFETY PRECAUTION	4	COLOR-ADJUSTING MODES	16~18
FUNCTIONS	5~6	REPLACEMENT PARTS LIST	19~40
BLOCK DIAGRAM	7	PACKING DIAGRAM	41
ALIGNMENT LOCATIONS	10	■ WITH SCHEMATIC DIAGRAM	
HOW TO REMOVE FOR SERVICE	8~9		

TAXAN

A General Guide to monitor display adjustment

The diagrams below show how to correct certain display problems using commonly available external monitor controls. Not all monitors have the full range of controls mentioned available externally, although they are all usually present in some form (often as factory pre-set controls on the internal circuit boards).

CAUTION - NEVER ADJUST A MONITOR'S CONTROLS WITH A METAL TOOL. ALWAYS USE A PLASTIC ADJUSTMENT TOOL.

Taxan monitors are usually provided with such a tool where external adjustments are likely to be required.

Vertical Position - adjust if image is not vertically centred on the screen

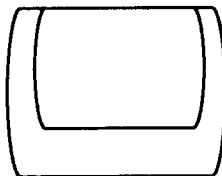

Vertical Hold - adjust if the image rolls vertically

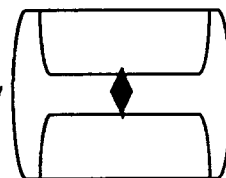

Vertical Size - adjust if the image does not fill the screen in the vertical direction.

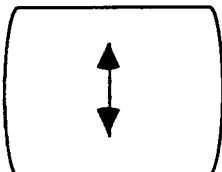

Horizontal Hold - adjust if the image is composed of moving diagonal lines.

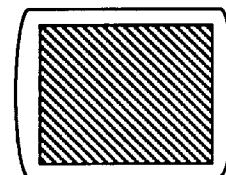

Side Pincushion - Adjust to straighten the sides of the image if they are curved inwards or outwards.

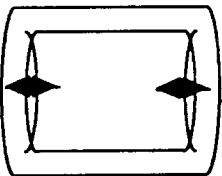

Horizontal Position - adjust to centre the image horizontally on the screen

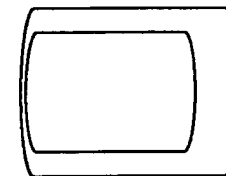

Vertical Linearity - adjust if areas of the image are wrongly proportioned.

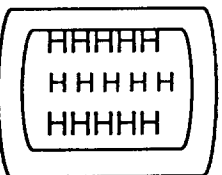

Horizontal Size - adjust if the image does not fill the screen in the horizontal direction.

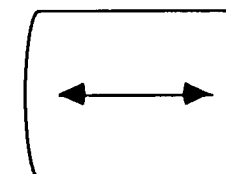



Safety Notices

Please Note:

The following information is provided in the interests of safety.

- 1). This equipment is mains powered (230 Volts AC) and is therefore potentially hazardous once the cover is removed.
- 2). Only trained engineering staff should attempt any work on the unit with the cover removed.
- 3). While servicing the unit, protect the mains supply to the equipment under test and all electrically powered test equipment with a suitably rated Residual Current Circuit Breaker (rccb) unit. These devices are readily available and are designed to remove the mains supply quickly in the event of a serious leakage of current to earth.
- 4). Ensure all test equipment, and the unit under test is adequately earthed.
- 5). Always discharge the CRT before attempting any work on the high voltage power circuits.
- 6). We advise the use of Electrostatic Damage Prevention equipment when servicing electronic equipment containing static sensitive devices.

SPECIFICATIONS

Type : 14-inch visual colour CRT display
 Picture tube : 14" V, 90° deflection, In-line electron guns.
 Dot trio phosphor (0.31 mm pitch)
 Short persistence
 Non-Glare / Tinted
 Recommendable display area : 252 mm(H) x 185 mm(V) : (CGA, EGA, PGC, TAXAN555)
 Power supply : 100 V AC – 240 V AC, 50 Hz/60 Hz
 Power consumption : 1.6 A (220 V AC)
 Input signal : TTL / Analog
 Input level : TTL Level / 0.7 Vp-p (Analog)
 Connector pin arrangement : ■ TTL Input Connector

1	GND	4	G	7	B''
2	R'	5	B	8	HD
3	R	6	G'/I	9	VD

■ Analog Input Connector

1	R	4	Comp Sync	7	GND
2	G	5	V Size	8	GND
3	B	6	GND	9	GND

Input impedance : 330 Ω (RGB TTL) / 75 Ω (RGB Analog)
 Input connector : 9 pin, D-sub connector (TTL / Analog)
 Video band width : 30 MHz (-3 dB)
 Scanning frequency : H : 15.0 kHz – 34 kHz
 V : 50 Hz – 90 Hz
 Retrace time : H : 6 μS (max)
 V : 700 μS (max)
 Anode voltage : 23.0 kV ± 1 kV
 Dimension : 356(W) x 308(H) x 395(D) mm
 Weight : 12.2 kg

VIDEO TIMING

1) CGA

Format : 640 x 200
 Pixel Clock (MHz) : 14.2

Horizontal

Scan Rate (kHz) : 15.75
 Blanking (μsec) : 11.1
 Left Border (μsec) : 2.8
 Active Display (μsec) : 44.8
 Right Border (μsec) : 5.0
 Front Porch (μsec) : 1.6
 Sync Width (μsec) : 3.75
 Back Porch (μsec) : 5.55
 Total (μsec) : 63.5

Vertical

Scan Rate (Hz) : 59.524
 Blanking (msec) : 1.02
 Top Border (msec) : 1.4
 Active Display (msec) : 12.86
 Bottom Border (msec) : 1.52
 Front Porch (msec) : 0.06
 Sync Width (msec) : 0.19
 Back Porch (msec) : 0.77
 Total (msec) : 16.8

VIDEO TIMING

1) TAXAN 555

Format 800 x 400
Pixel Clock (MHz) 27.43546

Horizontal

Scan Rate (kHz) 25.85812
Blanking (μsec) 9.513
Left Border (μsec) none
Active Display (μsec) 29.159
Right Border (μsec) none
Front Porch (μsec) 2.515
Sync Width (μsec) 1.822
Back Porch (μsec) 5.176
Total (μsec) 38.67

Vertical

Scan Rate (Hz) 56.7064
Blanking (msec) 1.02 2.166
Top Border (msec) none
Active Display (msec) 15.468
Bottom Border (msec) none
Front Porch (msec) 0.06 0.619
Sync Width (msec) 0.19 0.619
Back Porch (msec) 0.77 0.928
Total (msec) 17.634

VIDEO TIMING

3) EGA

Format 640 x 350
Pixel Clock (MHz) 16.2

Horizontal

Scan Rate (kHz) 21.85
Blanking (μsec) 6.4
Left Border (μsec) none
Active Display (μsec) 39.4
Right Border (μsec) none
Front Porch (μsec) 0
Sync Width (μsec) 4.8
Back Porch (μsec) 1.6
Total (μsec) 45.8

Vertical

Scan Rate (Hz) 59.88
Blanking (msec) 0.83
Top Border (msec) none
Active Display (msec) 15.87
Bottom Border (msec) none
Front Porch (msec) 0.14
Sync Width (msec) 0.6
Back Porch (msec) 0.09
Total (msec) 16.7

VIDEO TIMING

4) PGA

Format 640 x 400 640 x 480
Pixel Clock (MHz) 25 25

Horizontal

Scan Rate (kHz) 30.5 30.5
Blanking (μsec) 7.15 7.15
Left Border (μsec) none none
Active Display (μsec) 25.6 25.6
Right Border (μsec) none none
Front Porch (μsec) 0 0
Sync Width (μsec) 4.5 4.5
Back Porch (μsec) 2.65 2.65
Total (μsec) 32.75 32.75

Vertical

Scan Rate (Hz) 59.52
Blanking (μsec) 7.15 3.6 1
Top Border (msec) none none
Active Display (msec) 13.2 15.8
Bottom Border (msec) none none
Front Porch (msec) 1.5 0.2
Sync Width (msec) 0.066 0.066
Back Porch (msec) 2.034 0.734
Total (msec) 16.8 16.8

SAFETY PRECAUTION

1. The design of this product contains special hardware, many circuits and components specially for safety purposes. For continued protection, no changes should be made to the original design unless authorized in writing by the manufacturer. Replacement parts must be identical to those used in the original circuits. Service should be performed by qualified personnel only.
2. Alterations of the design or circuitry of display should not be made. Any design alterations or additions will void the manufacturer's warranty and will further relieve the manufacturer of responsibility for personal injury or property damage resulting therefrom.
3. Many electrical and mechanical parts in display sets have special safety-related characteristics. These characteristics are often not evident from visual inspection nor can the protection afforded by them necessarily be obtained by using replacement components rated for higher voltage, wattage, etc. Replacement parts which have these special safety characteristics are identified in the parts list of Service manual. Electrical components having such features are identified by shading on the schematics and by (Δ) on the parts list in Service manual. The use of a substitute replacement which does not have the same safety characteristics as the recommended replacement part shown in the parts list in Service manual may create shock, fire, or other hazards.
4. **Use isolation transformer when hot chassis.**
The chassis and any sub-chassis contained in some product are connected to one side of the AC power line. An isolation transformer of adequate capacity should be inserted between the product and the AC power supply point while performing any service on some product when the HOT chassis is exposed.
5. **Don't short between the LIVE side ground and NEUTRAL side ground when repairing.**
Some model's power circuit is partly different in the GND. The difference of the GND is shown by the LIVE (primary: \perp) side GND and the NEUTRAL (secondary: ///) side GND. Don't short between the LIVE side GND and NEUTRAL side GND or never measure with a measuring apparatus (oscilloscope etc.) the LIVE side GND and NEUTRAL side GND at the same time.
If above note will not be kept, a fuse or any parts will be broken.
6. If any repair has been made to the chassis, it is recommended that the B₁ setting should be checked or adjusted (See ADJUSTMENT OF B₁ VOLTAGE).
7. The high voltage applied to the picture tube must conform with that specified in Service manual. Excessive high voltage can cause an increase in X-Ray emission, arcing and possible component damage, therefore operation under excessive high voltage conditions should be kept to a minimum, or should be prevented. If severe arcing occurs, remove the AC power immediately and determine the cause by visual inspection (incorrect installation, cracked or melted high voltage harness, poor soldering, etc.). To maintain the proper minimum level of soft X-Ray emission, components in the high voltage circuitry including the picture tube must be the exact replacements or alternatives approved by the manufacturer of the complete product.
8. Do not check high voltage by drawing an arc. Use a high voltage meter or a high voltage probe with a VTVM. Discharge the picture tube before attempting meter connection, by connecting a clip lead to the ground frame and connecting the other end of the lead through a 10k Ω 2W resistor to the anode button.
9. When service is required, observe the original lead dress. Extra precaution should be given to assure correct lead dress in the high voltage circuit area. Where a short circuit has occurred, those components that indicate evidence of overheating should be replaced. Always use the manufacturer's replacement components.
10. **Isolation Check (Safety for Electrical Shock Hazard)**
After re-assembling the product, always perform an isolation check on the exposed metal parts of the cabinet (terminals, knobs, metal cabinet, screwheads, jack, control shafts, etc.) to be sure the product is safe to operate without danger of electrical shock.

(1) Dielectric Strength Test

The isolation between the AC primary circuit and all metal parts exposed to the user, particularly any exposed metal part having a return path to the chassis should withstand a voltage of 1,100V AC (r.m.s.) for a period of one second. Withstand a voltage of 1,100V AC (r.m.s.) to an appliance rated up to 120V, and 3,000V AC (r.m.s.) to an appliance rated 200V or more, for a period of one second.

This method of test requires a test equipment not generally found in the service trade.

(2) Leakage Current Check

Plug the AC line cord directly into the AC outlet (do not use a line isolation transformer during this check.). Using a "Leakage Current Tester", measure the leakage current from each exposed metal part of the cabinet, particularly any exposed metal part having a return path to the chassis, to a known good earth ground (water pipe, etc.). Any leakage current must not exceed 0.5mA AC (r.m.s.).

• Alternate Check Method

Plug the AC line cord directly into the AC outlet (do not use a line isolation transformer during this check.). Use an AC voltmeter having 1,000 ohms per volt or more sensitivity in the following manner. Connect a 1,500 Ω 10W resistor paralleled by a 0.15 μ F AC-type capacitor between an exposed metal part and a known good earth ground (water pipe, etc.).

Measure the AC voltage across the resistor with the AC voltmeter.

Move the resistor connection to each exposed metal part, particularly any exposed metal part having a return path to the chassis, and measure the AC voltage across the resistor. Now, reverse the plug in the AC outlet and repeat each measurement. Any voltage measured must not exceed 0.35V AC (r.m.s.). This corresponds to 0.5mA AC (r.m.s.).

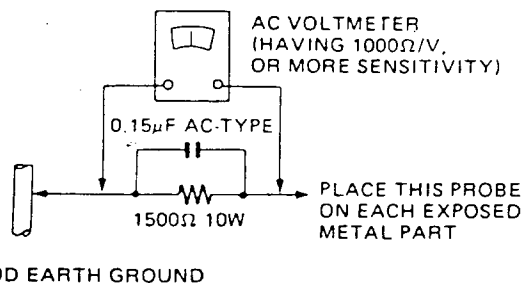

11. High voltage hold down circuit check.

After repair of the high voltage hold down circuit, this circuit shall be checked to operate correctly.

See item "How to check the high voltage hold down circuit".

FUNCTIONS

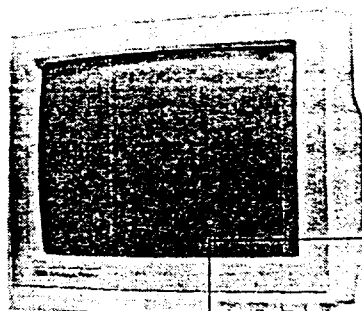

FRONT VIEW

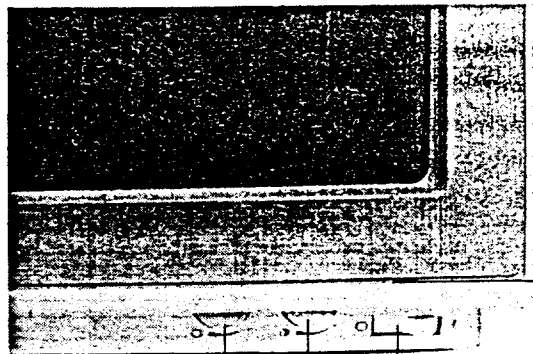

- ① **POWER indicator**
Lights when the power is turned on.
- ② **CONTRAST control**
Turn to adjust the contrast of the picture to your preference. Center click is the standard setting.
- ③ **POWER switch**
Press the "I" side to turn the power on. The POWER indicator ① lights. Press the "O" side to turn the power off.
- ④ **BRIGHT control**
Turn to adjust the picture brightness to your preference. Center click is the standard setting.

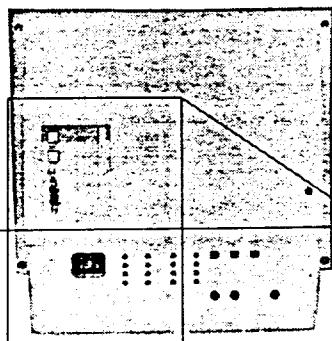

REAR VIEW (II)

- ① **AC INPUT Connector**
Connect to the power cord (3-prong Type).
- ② **SIGNAL INPUT connector**
Connect to the RGB output (either TTL or analog) of the computer. Use the signal cable provided for connection.
- ③ **ANALOG/TTL switch**
ANALOG: Set to this position when connected to equipment which outputs RGB analog signals (such as the PGA).
TTL: Set to this position when connected to equipment which outputs RGB TTL signals (such as the TAXAN 555, MDA, CGA or EGA).
- ④ **COLOR/MONO switch**
 Use only when TTL signals are input. Press to switch the picture mode depending on the signals input.
COLOR: Set to this position when TTL color signals are input. (When connected to the TAXAN 555, CGA or EGA, etc.)
MONO: Set to this position when TTL monochrome signals are input. (When connected to the MDA, etc.)

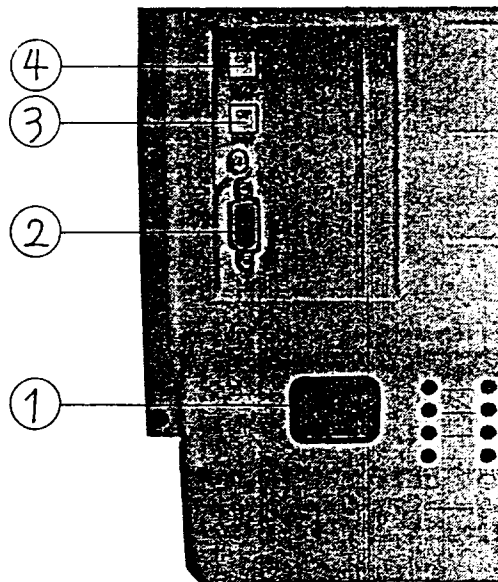

REAR VIEW(I)

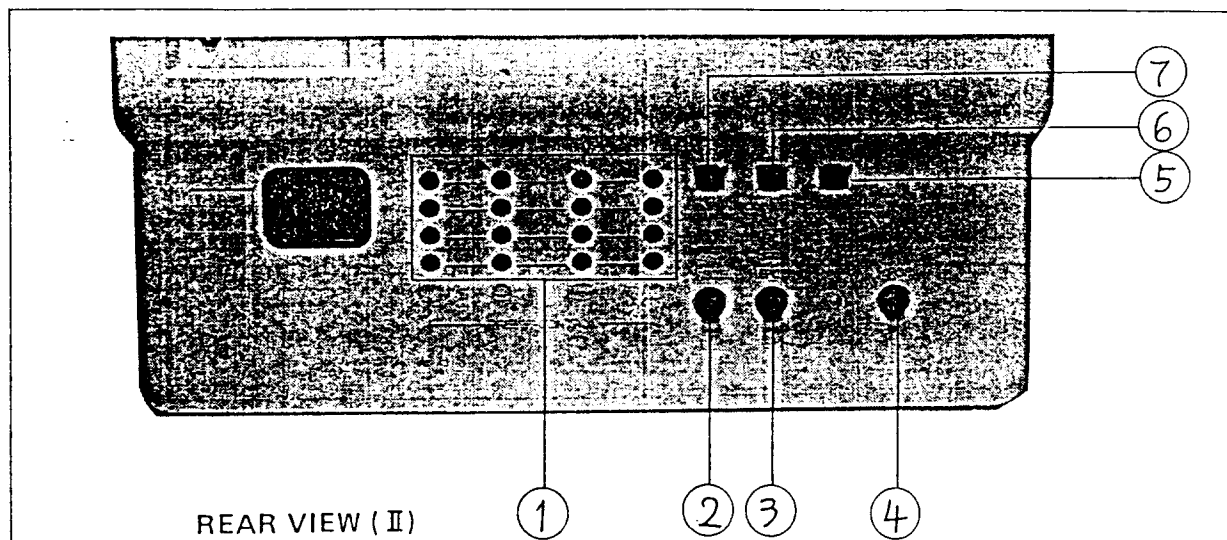

① PRESET CONTROL screws

These function as sub controls to vary the adjustment range of the center clicks of picture controls ②, ③ and ④.

- ⊞ : Vertical size control
- ⊞ : Vertical position control
- ⊞ : Horizontal size control*
- ⊞ : Horizontal position control

(* Horizontal size control screw functions as the main control.)

Turn the appropriate group of screws (A, B, C or D) depending on the setting of the PRESET switch (depending on the computer connected); with controls ②, ③ and ④ restored to their center click positions. Use a screwdriver to turn them.

- 1) When the PRESET switch is set to "AUTO" (when connected to an IBM, IBM-compatible computer or TAXAN 555. Turn A, B, C or D screws according to the chart below.

Screw groups	Adapter (board) used
A	PGA* (f _H ** = 30.48 kHz)
B	TAXAN 555 (f _H = 25.85 kHz)
C	CGA* or EGA* (f _H = 15.75 kHz)
D	EGA* (f _H = 21.85 kHz)

*PGA = Professional Graphics Adapter
 EGA = Enhanced Graphics Adapter
 CGA = Color Graphics Adapter

**f_H = Horizontal scanning frequency

Note: When using the MDA, adjust group A's PRESET CONTROL screws. In this case, the EGA presetting will be cancelled.

- 2) When the PRESET switch is set to "RELEASE" (when connected to a computer other than the above) Turn only "A" screws. (Other groups of screws have no effect.)

② V. SIZE control

Turn to adjust the vertical size of the picture. Center click is the standard setting.

③ V. POSI. control

Turn to adjust the vertical position of the picture. Center click is the standard setting.

④ H. POSI. control

Turn to adjust the horizontal position of the picture. Center click is the standard setting.

⑤ COLOR MODE switch

Use only when the TTL signals are input and when the COLOR/MONO switch is set to "COLOR". Press to switch the color mode according to the computer connected.

AUTO: Set to this position when connected to an IBM or IBM-compatible computer;

16 COLORS: Set to this position when connected to a computer other than above and 16 colors cannot be correctly displayed if it is in the 16-color display mode (TAXAN 555).

⑥ SCAN SIZE switch

Press to switch the size of the picture on the screen

AUTO: Set to this position when connected to an IBM, IBM-compatible computer or TAXAN 555. The picture size is determined automatically.

OVER SCAN: Set to this position when connected to a computer other than the above and the picture is too small.

⑦ PRESET switch

AUTO: Set to this position when connected to an IBM, IBM-compatible computer or TAXAN 555. The monitor automatically selects the setting of the appropriate PRESET CONTROL screw group (A, B, C or D) depending on the computer connected;

RELEASE: Set to this position when connected to a computer other than the above.

BLOCK DIAGRAM

(SV-775E)

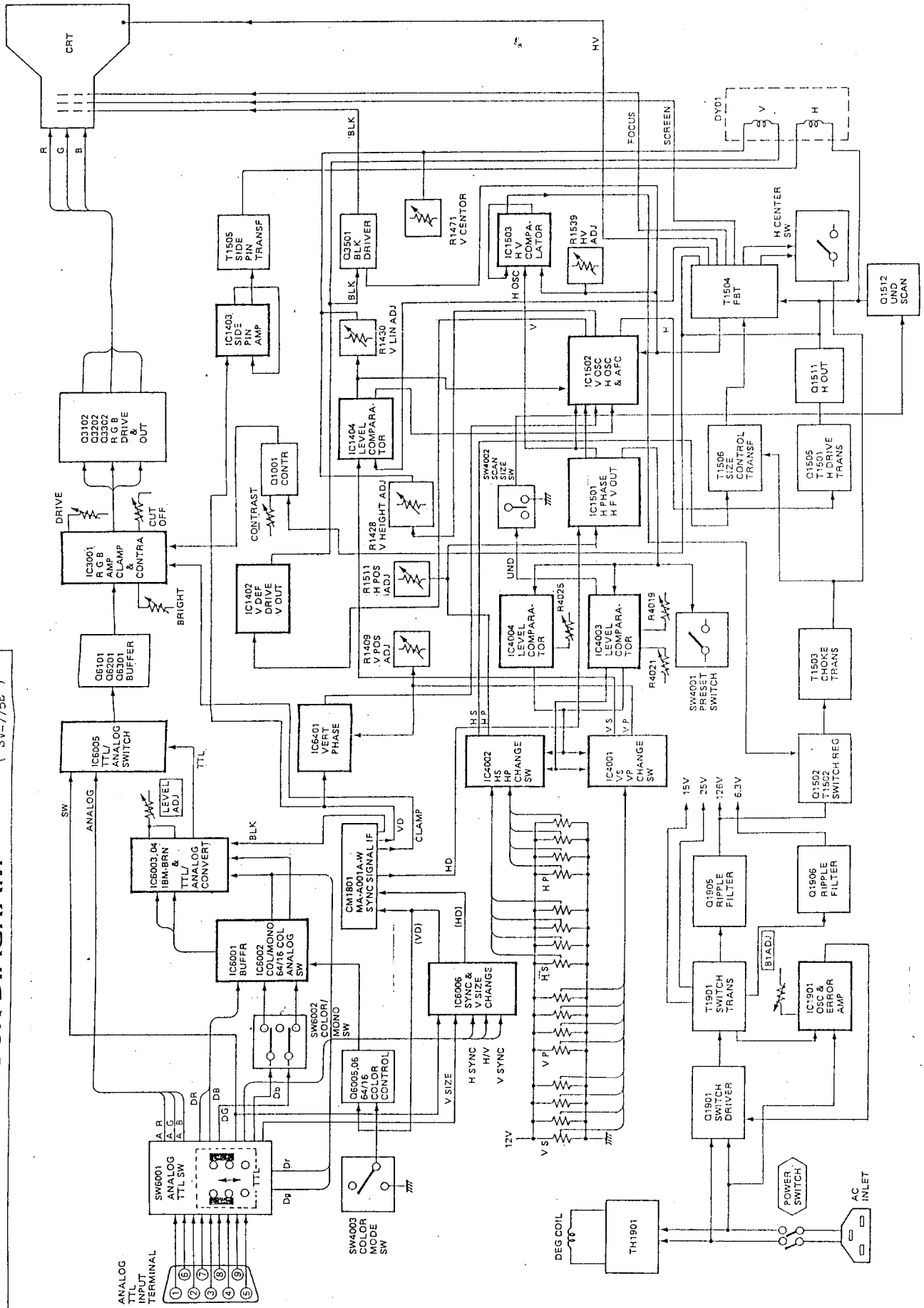

HOW TO REMOVE FOR SERVICE

■ REMOVING THE REAR CABINET

1. Unplug the power supply cord and unscrew the six screws marked (A) shown in Fig. 1.

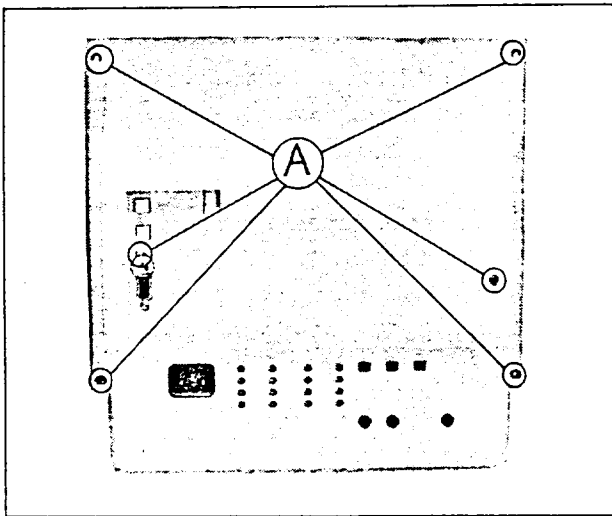

FIG. 1

■ REMOVING THE CHASSIS

* After removing the rear cabinet.

1. Remove the thirteen screws marked (B) shown in Fig. 2, 3 and 4.
2. Loosen a screw marked (C) shown in Fig. 5.
3. Remove the CRT socket holder, connectors, and wire clamps (if necessary).

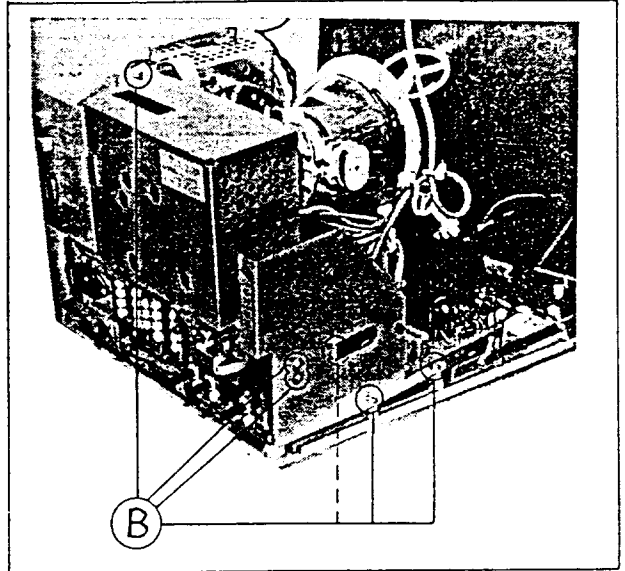

FIG. 3

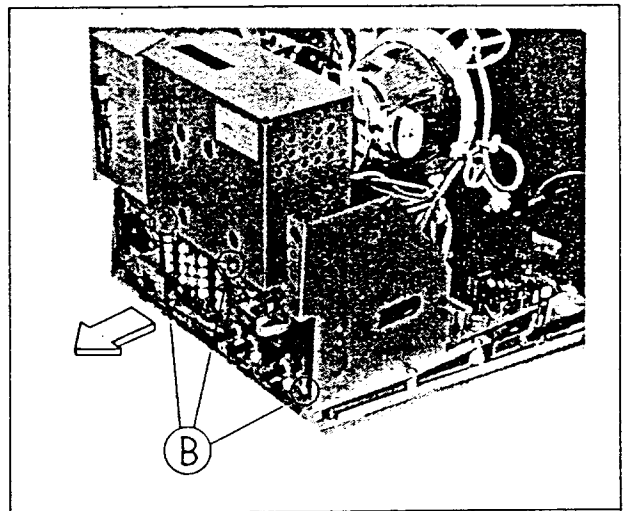

FIG. 4

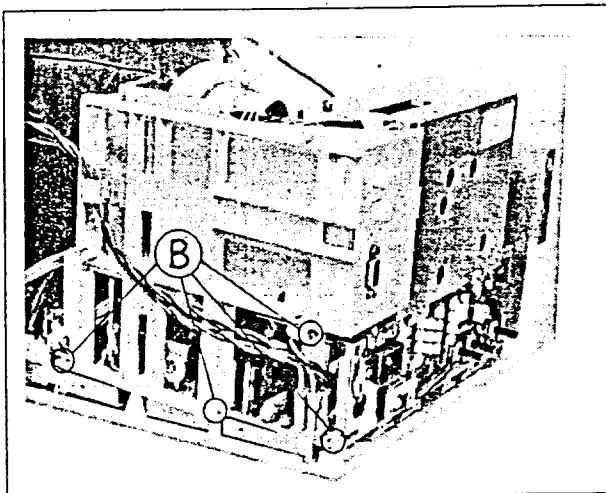

FIG. 2

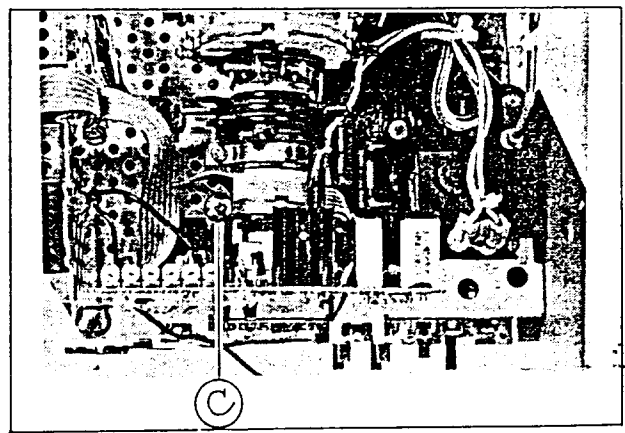

FIG. 5

4. Withdraw the PC Board chassis backward.
 - * When conducting a check with power supplied, be sure to confirm that the CRT earth wire is connected to the CRT socket board and the chassis (Fig. 6).

■ REMOVING THE INPUT PC BOARD

- * After removing the rear cabinet and the chassis.
1. Remove the three screws marked (D) shown in Fig. 7.
 2. Then remove the INPUT PC Board to allow direction marked (E) shown in Fig. 7.
 3. Remove the five screws marked (F) shown in Fig. 8.
 4. Then pull out the shielded cover from installed position (Fig. 9).

■ WIRE CLAMPING AND TYING BAND

1. Be sure to clamp the wire.
2. Never remove the tying band used for wire clamping. Should it be inadvertently removed, be sure to clamp the wire again, using insulating material.

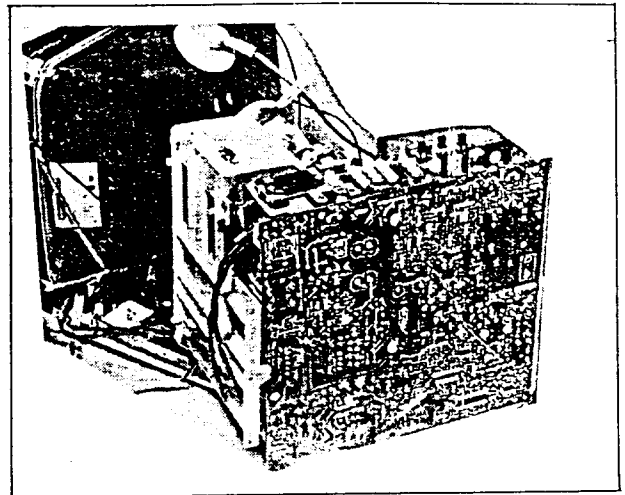

FIG. 6

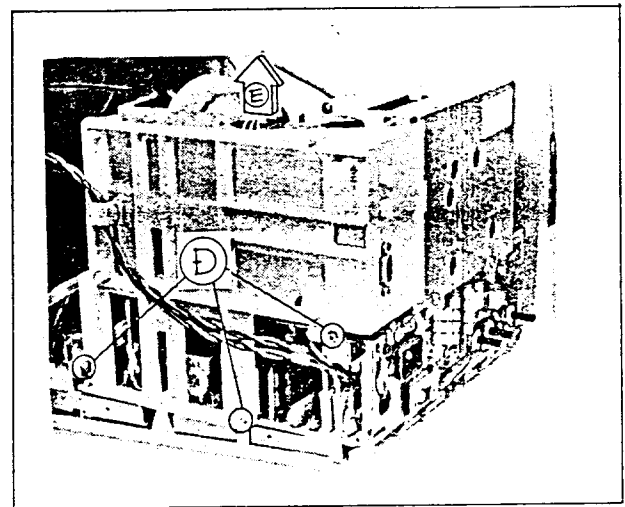

FIG. 7

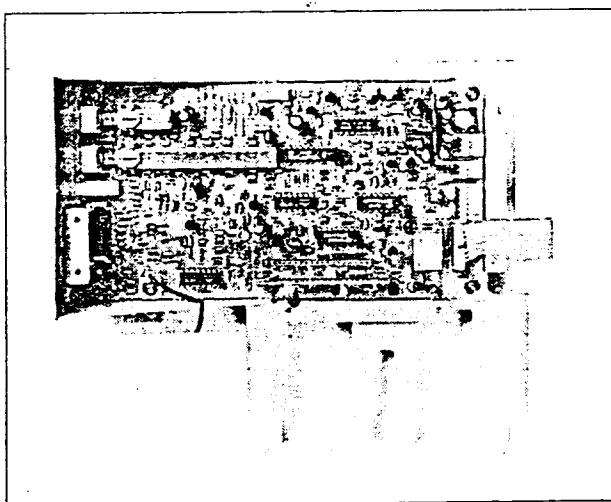

FIG. 9

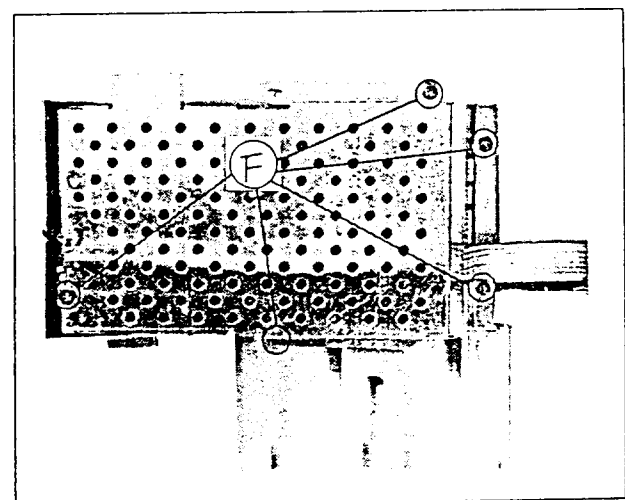
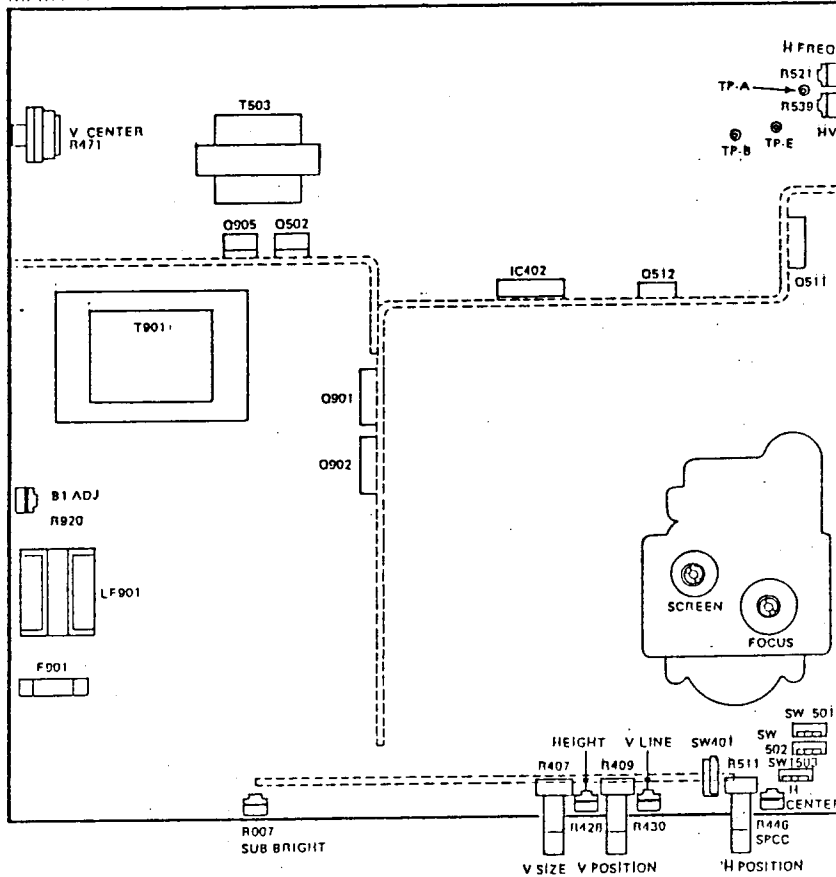

FIG. 8

ALIGNMENT LOCATION

MAIN P.B



CRT SOCKET P.B

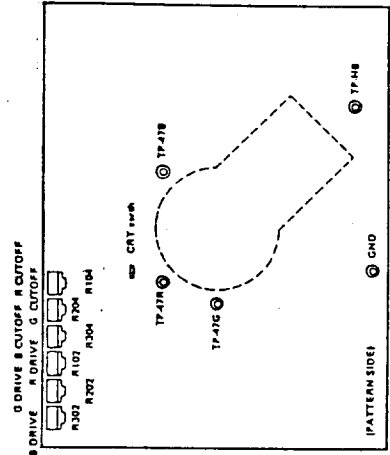

INPUT P.B

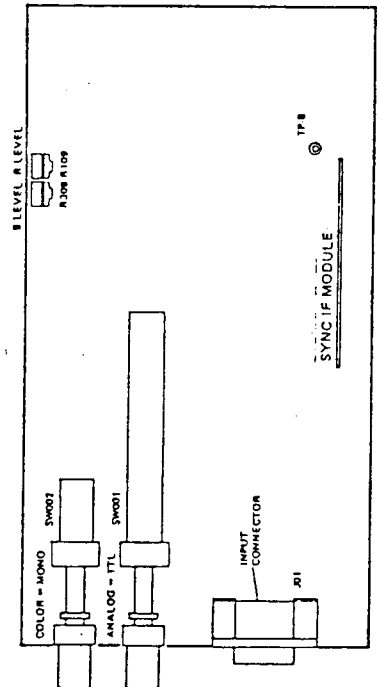

CONTROL P.B

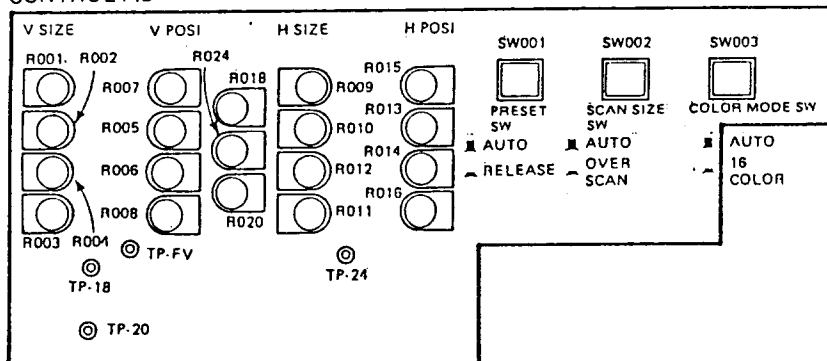

SERVICE ADJUSTMENTS

PREPARATION BEFORE MAKING ADJUSTMENT

1. Measuring instruments and jigs required for adjustment.
 - ° RGB signal generator (make use of TTL Level and Anarog)
 - ° Oscilloscope
 - ° Voltmeter (Digital Voltmeter, Tester, etc.)
 - ° Knob screw driver
 - ° Hexagon core wrench
 - ° Scale
2. Turn the power on the unit to be adjusted and the measuring instruments at least 30 minutes beforehand for warming-up.
- Before adjusting each section, confirm that the following rough adjustments have been completed.
 - (1) Confirm that the white balance has been adjusted. If it is out of order, adjust it by following the description in "White Balance Adjustment".
 - (2) Adjust the vertical synchronization by using the V HOLD VR, and confirm also that the horizontal synchronization is normal. If it is out of order, adjust it by following the descriptions in "H HOLD Adjustment".
 - (3) Display @ and confirm that the picture is in focus.

GENERAL ADJUSTMENT

1. Adjustment of B1 Voltage
 - (1) Confirm that the AC input voltage is 230 V.
 - (2) No video apply. (FH = 21.85 kHz)
 - (3) Adjust the voltage of TP-HB (located on the CRT socket PB) to 126 V \pm 1 V by using the B1 ADJ VR(R1920).
 - (4) Confirm that the B1 voltage is 126 V \pm 1 V even if the AC input voltage is changed to 108 V ~ 132 V.
2. Adjustment of H Hold
 - (1) Display cross-hatch or white field pattern. ($f_H = 21.85$ kHz, $f_V = 60$ Hz)
 - (2) Initiate free running status by connecting the TP-B and TP-E.

- (3) Adjust the H FREQ VR(R1521) until the pattern is almost stable.
- (4) Check to see if horizontal synchronization is fully established even if the cabling in (2) is disconnected and FH is changed to 15.75 kHz (CGA), 21.85 kHz (EGA) or 30.5 kHz (PGC).

* Note

If the monitor is not synchronized by 15.75 kHz or 30.5 kHz improper adjustment or trouble in the MA-A001A-W modules may be the cause.

3. Adjustment of High Voltage

- * Confirm that the H HEIGHT has been adjusted and that the H HOLD and V HOLD have not been turned on.
- (1) Be sure and connect the earth of high voltage meter with chassis frame.
 - (2) Connect the probe of high voltage meter with the anode of CRT.
 - (3) No video apply. FH = 21.85 kHz. (if raster is shown then adjust the BRIGHT VR or SCREEN VR until no raster)
 - (4) Adjust the HV ADJ VR(R1539) until the high voltage is 23 kV \pm 0.1 kV.
 - (5) Check to see the High Voltage is from 23.0 kV \pm 1 kV. When f_r is changed to 15.75 kHz (CGA) and 30.5 kHz (PGC).

4. Focusing Adjustment

- * Confirm that the HV and WHITE BALANCE have been adjusted.
- (1) Display the @ mark over the entire screen (against the background).
 - (2) The CONTRAST VR should be turned to the position where @ mark is just before saturated.
 - (3) Adjust the FOCUS VR until the center and peripheral areas are uniformly in focus.

5. How to Check the High Voltage Protective Circuit

- (1) High voltage protective circuit. After repair of the high voltage protective circuit shown in Fig. 5-1, this circuit shall be checked to operate correctly.
- (2) Checking method of the high voltage protective circuit.
 - 1) Connect the resistor (10 k Ω) and potentiometer (100 k Ω) at TP-A & Earth. (TP-E)

- 2) Rotate the potentiometer so the resistance decrease.
- 3) Confirm the picture goes out before high voltage reaches 26.5 kV.

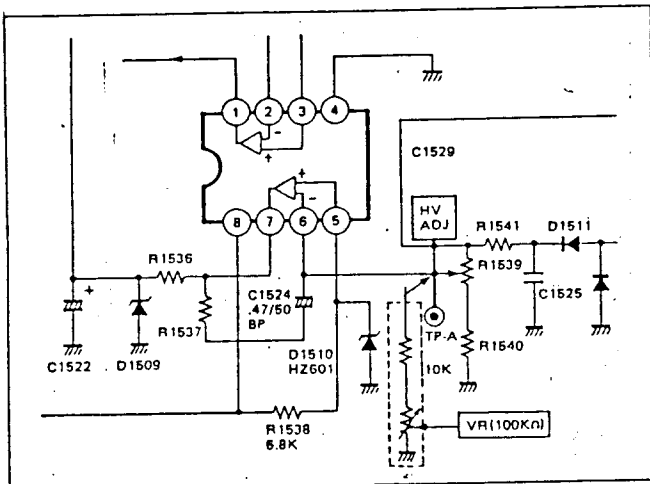
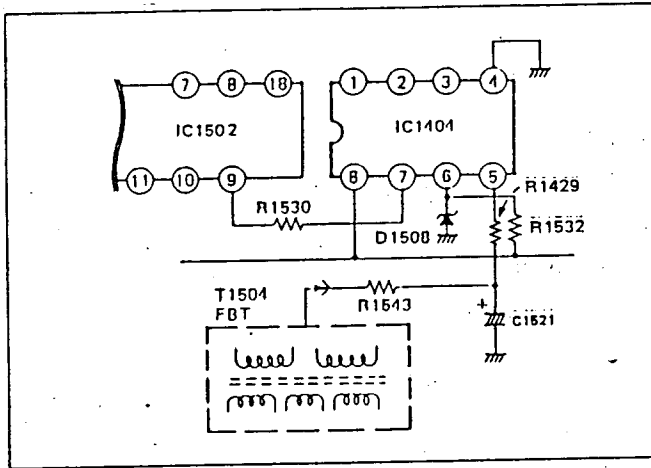

■ Adjustment of SIZE/POSI VR Select

- (1) Set the rear control VR (R1407, R1409, R1506 and R1511) to central (click) position.
- (2) Turn the R4018, R4020 and R4024 fully clockwise.
- (3) Set the both of preset cancel SW and over scan SW to the OFF (AUTO) position.
- (4) After inputting the signal of $f_H = 23.5$ kHz, read the value on the digital voltmeter, and adjust the R4018 so that the voltage of TP-18 becomes the same value of the TP- f_V .
- (5) After inputting the signal of $f_H = 28.5$ kHz, read the value on the digital voltmeter, and adjust the R4024 so that the voltage of TP-24 becomes the same value of the TP- f_V .
- (6) Then, after inputting the signal of $f_H = 17.125$ kHz, read the value on the digital voltmeter, and adjust the R4020 so that the voltage of TP-20 becomes the same value of the TP- f_V .

- (7) By inputting the signals of CGA (15.75 kHz), EGA (21.85 kHz), TAXAN 555 (25.85 kHz) and PGC (30.5 kHz); confirm that each VR can be varied, respectively.

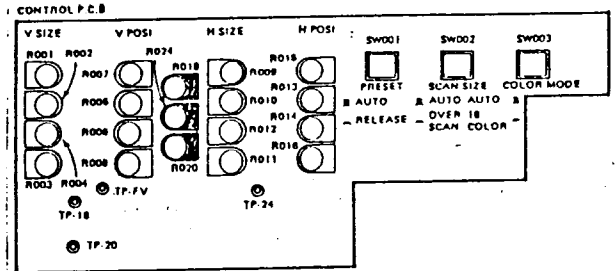

■ Confirmation of the Actions of PRESET SW and SCAN SIZE SW.

- (1) Confirmation of PRESET SW
 - 1) Confirm that when PRESET SW is positioned at RELEASE (A: ON condition) is any of CGA (15.75 kHz), TAXAN 555 (25.85 kHz), EGA (21.85 kHz) or PGC (30.5 kHz) is input, the variable motion of H SIZE, H POSI, V SIZE and V POSI cannot be operated by PRESET VR of "A".
 - 2) Return the PRESET SW to AUTO (OFF condition) and input PGC (30.5 kHz) and readjust the size of H and V by PRESET VR of "A".
- (2) Confirmation of SCAN SIZE SW

Confirm that when TAXAN 555 (25.85 kHz), EGA and PGC are inputted, if SW is positioned at OVER SCAN (ON condition), the picture is in the condition of over scan.

* Don't rotate the R4018, R4020 and R4024. The R4001, R4018, R4020 and R4024 can be operated even if at RELEASE (A: ON condition) position.

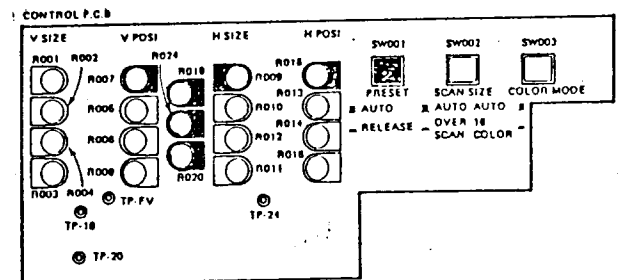

■ Adjustment of Vertical Height

- * Confirm that the H FREQ and HB ADJ have been adjusted.
- (1) Display cross-hatch pattern: ($f_H = 15.75$ kHz, $f_V = 60$ Hz, over scan mode)

- (2) Set the V SIZE VR(C R1407 and R4004) to the maximum position.
- (3) If SIZE/POSI VR not adjusted, Set the SCAN SIZE SW to OVER SCAN MODE.
- (4) By rotating the V HEIGHT VR(R1428), adjust the voltage so that it becomes $5.2 \text{ V} \pm 0.2 \text{ V}$.
- (5) After the above adjustment, ensure that the height can be varied by rotating the V SIZE VR.

■ Adjustment of Vertical Linearity

- * Confirm that the H HOLD and HV have been adjusted.
- (1) Display cross-hatch pattern. ($f_v = 60 \text{ Hz}$, $f_H = 21.85 \text{ kHz}$)
 - (2) Set the height to its maximum by the V SIZE VR(R1407 & R4003).
 - (3) Adjust the upper and lower linearity to an optimum by the V LIN VR(R1430).
 - (4) After the above adjustment, ensure that the height can be varied by rotating the V SIZE VR(R1407).
 - (5) Change the input frequency f_v to 50Hz, 90Hz and check to see if the linearity at this frequency is the same as in $f_v = 60\text{Hz}$. Adjust the V LIN VR (R1430) again if the above is not true.
 - (6) Check to see if the V SIZE VR as in an input frequency f_v of 90 Hz when 50 Hz is selected.

■ Adjustment of H Center and V Center

- * Confirm that the V HEIGHT and V LIN have been adjusted.
- (1) No video apply. ($f_H = 21.85\text{kHz}$ $f_v = 60 \text{ Hz}$) & under scan SW set to ON.
 - (2) Adjust the BRIGHT VR until the raster on the screen is just barely visible.
 - * If the raster overflowed the screen, reduce the screen size by rotating the H SIZE VR (A) and V SIZE VR (A) of the PRESET.
 - (3) Adjust the V CENTER VR(R1471) until the raster is vertically centered in the screen.
 - (4) Adjust the H CENTER SW(S1501, S1502) until the raster is horizontally centered in the screen. In case of can't H Center adjustment, change the position of H CENTER SW(S1503). Then readjust again.
 - * The S1501 and S1502 should be changed simultaneously.

■ Adjustment of H Width, H Posi, V Height and V Posi (at PGC) [I]

- * Confirm that the H HOLD, HV, V HEIGHT, V LIN, H CENT, V CENT, SIZE and the POSI VR SELECT have been adjusted.
- (1) Set the contrast VR to max & Bright VR to central (click) position.
 - (2) Display cross-hatch pattern. ($f_H = 30.5 \text{ kHz}$)
 - (3) Adjust the H SIZE VR(A: R4009) until the horizontal width becomes $252 \text{ mm} \pm 4 \text{ mm}$.
 - (4) Adjust the H POSI VR(A: R4015) until the pattern becomes horizontally centered in the screen.
 - (5) Adjust the V SIZE VR(A: R4001) until the vertical height becomes $185 \text{ mm} \pm 4 \text{ mm}$.
 - (6) Adjust the V POSI VR(A: R4007) until the pattern becomes vertically centered in the screen.

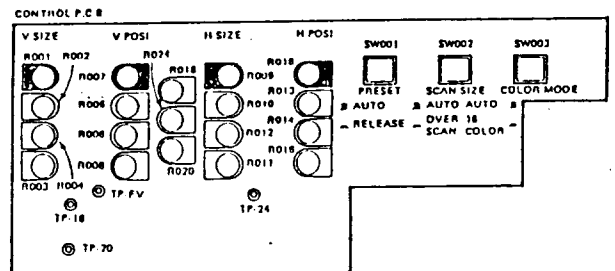

■ Adjustment of H Width, H Posi, V Height and V Posi (at TAXAN 555) [II]

- * Confirm that the H HOLD, HV, V HEIGHT, V LIN, H CENT, V CENT, SIZE and the POSI VR SELECT have been adjusted.
- (1) Set the CONTRAST VR to max, and BRIGHT VR to the center (click) position.
 - (2) Display cross-hatch pattern. ($f_H = 25.85 \text{ kHz}$)
 - (3) Adjust the H SIZE VR(B R4010) until the horizontal width becomes $252 \text{ mm} \pm 4 \text{ mm}$.
 - (4) Adjust the H POSI VR(B R4013) until the pattern becomes horizontally centered in the screen.
 - (5) Adjust the V SIZE VR(B R4002) until the vertical height becomes $185 \text{ mm} \pm 4 \text{ mm}$.
 - (6) Adjust the V POSI VR(B R4005) until the pattern becomes vertically centered in the screen.

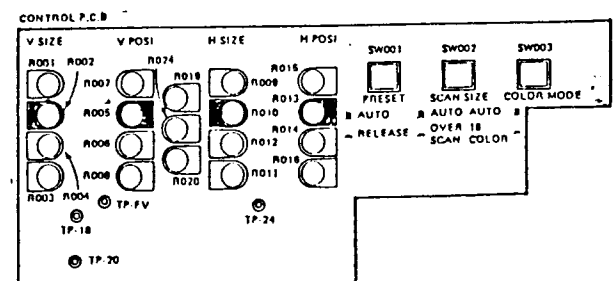

■ Adjustment of H Width, H Posi, V Height and V Posi (at CGA) (III)

* Confirm that the H HOLD, HV, V HEIGHT, V LIN, H CENT, V CENT, SIZE and the POSI VR SELECT have been adjusted.

- (1) Set the CONTRAST VR to max, and BRIGHT VR to the center (click) position.
- (2) Display cross-hatch pattern. ($f_H = 15.75$ kHz)
- (3) Adjust the H SIZE VR(C R4012) until the horizontal width becomes $252 \text{ mm} \pm 4 \text{ mm}$.
- (4) Adjust the H POSI VR(C R4014) until the pattern becomes horizontally centered in the screen.
- (5) Adjust the V SIZE VR(C R4004) until the vertical height becomes $185 \text{ mm} \pm 4 \text{ mm}$.
- (6) Adjust the V POSI VR(C R4006) until the pattern becomes vertically centered in the screen.

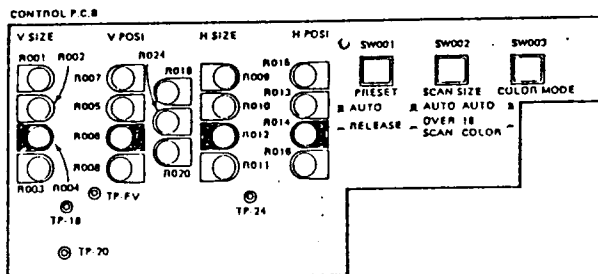

■ Adjustment of H Width, H Posi, V Height and V Posi (at EGA) (IV)

* Confirm that the H HOLD, HV, V HEIGHT, V LIN, H CENT, V CENT, SIZE and the POSI VR SELECT have been adjusted.

- (1) Set the CONTRAST VR to max and BRIGHT VR to the center (click) position.
- (2) Display cross-hatch pattern. ($f_H = 21.85$ kHz)
- (3) Adjust the H SIZE VR(D R4011) until the horizontal width becomes $252 \text{ mm} \pm 4 \text{ mm}$.
- (4) Adjust the H POSI VR(D R4016) until the pattern becomes horizontally centered in the screen.
- (5) Adjust the V SIZE VR(D R4003) until the vertical height becomes $185 \text{ mm} \pm 4 \text{ mm}$.
- (6) Adjust the V POSI VR(D R4008) until the pattern becomes vertically centered in the screen.

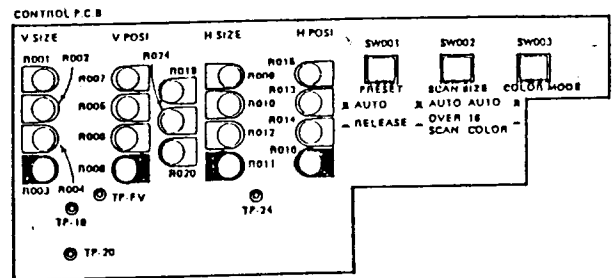

■ Adjustment of Side Pin Cushion

* Confirm that the V HEIGHT, V LIN, and the UNDER SCAN V HEIGHT have been adjusted.

- (1) Display cross-hatch pattern. ($f_H = 21.85$ kHz, $f_V = 60$ Hz)
- (2) Adjust the SPCC VR(R1446) until the side pin cushion to its optimum.
- (3) Confirm that the side pin cushion is proper by changing f_V to 50 Hz and 90 Hz. Perform the procedure describe in (3) above if the side pin cushion in malfunctioning at 50 Hz or 90 Hz.
- (4) Confirm that the side pin cushion at cross-hatch pattern of $f_V = 15.75$ kHz.

■ White Balance Adjustment

Cut-off VR Adjustment

- (1) No Video apply.
- (2) Turn the CUT OFF VRs(R3104, R3204, R3304) and the SCREEN VR fully counterclockwise.
- (3) Set the SERVICE SW(SW1401) to the "S" position.
- (4) Set the BRIGHTNESS VR to the center position (click).
- (5) Connect the oscilloscope to TP-47R, adjust the subbright VR(R1007) until no pulse is generated.
- (6) Connect the oscilloscope to TP-47R, TP-47G and TP-47B and adjust the CUT OFF VR so that each output becomes 110 V.
- (7) Turn the SCREEN VR clockwise to a position where a single line is faintly displayed.
- (8) Not using the CUT OFF VR which produced a color first, but using the other two CUT OFF VRs, adjust the colors so that the three colors emit a little light at the same level.
- (9) Set the SERVICE SW to the "N" position.

Drive VR Adjustment

- (10) Set the CONTRAST VR(R4081) to its maximum position.
- (11) Display cross-hatch pattern. (input the analog signal)

- (12) Connect the oscilloscope to TP-47R and adjust the RED DRIVE VR(R3102) so that the drive voltage from the black to white levels becomes $40 \text{ Vp-p} \pm 2 \text{ Vp-p}$.

* Use vertical cycle of oscilloscope.

- (13) Display white field pattern. (Signal with which the beam limiter is not applied)
- (14) Adjust the DRIVE VRs for G and B (excluding that for R) until the raster becomes white.

* In case of used color analyzer. (ex. MINOLTA TV-COLOR ANALYZER II TV-2140)

- (13) Set the color analyzer.
- (14) Adjust the DRIVE VRs for G and B (excluding that for R) until the $x = 0.281 \text{ Y} = 0.311$. (CIE 1931)
- (15) When the contrast is adjusted to its maximum, confirm that the brightness is more than 45 ft-L.
- (16) Input the TTL signal. (Confirm that the I-signal is input.)
- (17) TTL/ANALOG switch(SW6109) to TTL side.
- (18) Display white field pattern. (Signal with which the beam limiter is not applied)
- (19) Adjust the TTL R LEVEL VR(R6109) and TTL B LEVEL VR(R6309) until the raster becomes white.
- (20) Confirm that the white balance is the designated color temperature.

■ Confirmation of Action of Synchronizing Signals

- (1) Confirm of TTL input position
H SYNC is connected to pin ⑧ of the 9 pin connector and V SYNC is connected to pin ⑨ of the same connector. Confirm that irrespective

of the polarity of each synchronizing signal, positive or negative, the monitor is correctly synchronized with respect to (HS) 15.75 kHz, 21.85 kHz and (VS) 50 Hz, 60 Hz, 90 Hz.

- (2) Confirm of ANALOG input position
Input the composite synchronizing signal of HS and VS to pin ④ of the 9 pin connector and confirm that the monitor is correctly synchronized with respect to (HS) 30.5 kHz of negative polarity.

■ Confirm of Input of TTL Signals

- (1) Confirm of display of 16 colors
1) Confirm that COLOR MODE SW is at the AUTO position(OFF condition).
2) Input R, G, B, I and +VD and confirm that 16 colors can be displayed by a combination of these signals.
- (2) Confirm of display of 64 colors
1) Confirm that COLOR MODE SW is at the AUTO position(OFF condition).
2) Input R, G, B, R', G', B' and -VD and confirm that 64 colors can be displayed by a combination of these signals.
- (3) Confirm that when COLOR MODE SW is made to 16 COLORS(ON condition) with the same signals as in item (2) the display is changed from 64 color display to 16 color display.

Note: Confirmation of 8 color display is done concurrently with that of 16 color display. In the case of 8 color display, I signal is not included, so that the brightness is 60 to 70% of that of 16 color display.

ADJUSTMENT OF MODULE

1. Adjustment of MA-A001A Module

- (1) Input the signal of $f_H = 15.75 \text{ kHz}$.
- (2) Adjust the pulse width of the output wave form of pin ⑱ to $40 \pm 1 \mu\text{sec}$ by adjusting VR(R25) in the module.

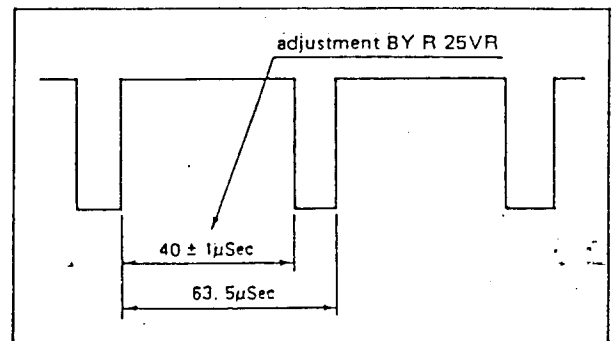

Output Wave Form of Pin ⑱

COLOR-ADJUSTING MODES FOR CRT DISPLAY

- Make an adjustment when replacing a cathode-ray tube or when color shading occurs. Basically, adjustment can be made in the same manner as for television, but, concerning display characteristics, it requires a greater degree of accuracy than television. Moreover, functions such as convergence take place in a quite delicate manner because a high-finesness CRT or medium-finesness CRT are used as the cathode-ray tube. Therefore, extreme care should be exercised when carrying out the adjustment.

■ CRT REPLACEMENT AND PREPARATIONS TO BE CONDUCTED BEFORE COMMENCING ADJUSTMENT

1. Wipe the entire CRT body lightly with a cloth.
2. Wind adhesive tape around two places on the neck part of the CRT. (Fig. 1)

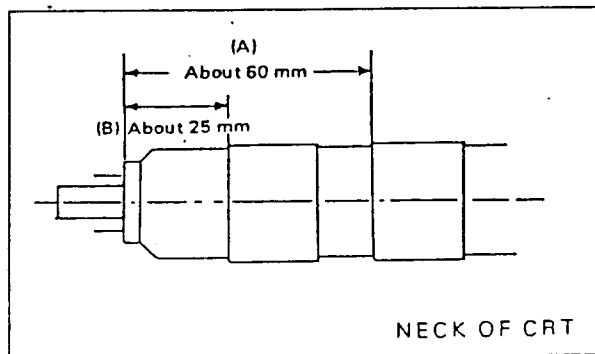

Fig. 1

3. Insert a deflecting yoke into the neck of the CRT without removing the tape.
4. Fasten a clamp screw so that the deflecting yoke is easily turned.
5. Attach a PC magnet and fasten a clamp screw.
6. As it is affected by the earth's magnetism, point the front of the CRT tube to the east or west (when a setting place is known beforehand, set it accordingly).
7. After attaching and wiring the deflecting yoke, CRT, socket, anode and earth, turn the switch "on" and confirm that a picture appears. Then make sure to demagnetize the entire CRT with a degaussing coil.

■ PURITY ADJUSTMENT

Before starting the adjustment

1. Demagnetize with a degaussing coil.
2. Remove the adhesive which is fixing the 6 magnet plates using a screwdriver, and loosen the magnet lock so that the magnet plates can be turned.

Adjusting Modes

1. Turn a green cutoff VR and a red/blue cutoff VR to the extreme right and left, respectively. Under this condition, the raster is easier to see when adjusting a screen VR.
2. Loosen the clamp screw fastening the deflecting yoke and draw the deflecting yoke to the extreme rear to produce round-shaped color shading (when phosphors of the RGB is coated in stripes, it appears as vertical stripes).
3. Overlap the long and short tabs of two purity magnets alternately and temporarily set them in a horizontal position.
4. Making and breaking the tabs of the two purity magnets, set a green circle (or a vertical stripe) in the center of the screen.
5. Push the deflecting yoke forward, and fix it so that the entire screen becomes green.
6. Produce a horizontal line and correct the inclination of it with the deflecting yoke (do not alter the forward and rear positions of the deflecting yoke).
7. Bring the single line back.
8. Fasten the deflecting yoke so that it does not move both forward and backward (do not change the inclination or forward and rear positions of it).
9. Fasten the magnet lock tightly.
10. Produce a white screen and degauss it, then check if there is any color shading.
 - * If color shading appears, the deflecting yoke is either leaning forward or backward, and should be corrected.

■ STATIC (CENTER) CONVERGENCE ADJUSTMENT

Before Adjustment

1. Display a cross-hatch pattern.
2. Moving the deflecting yoke up and down and to the right and left, adjust the convergence around the periphery. Also, temporarily place a wedge on the upper part of the deflecting yoke. (Fig. 2)

Adjusting Mode

1. Overlap red and blue lines in the center of the screen with a four-pole magnet and produce a magenta color.
2. Overlap the red/blue (magenta) line placed in the center of the screen and the green line with a six-pole magnet.
3. Repeating 1 and 2, perfectly match the longitudinal and vertical lines located in the center of the screen.

■ DYNAMIC (PERIPHERY) CONVERGENCE ADJUSTMENT

Adjusting Mode

1. Remove the wedge with which the deflecting yoke was temporarily fixed.
2. Oscillating the deflecting yoke up and down, set a convergence of points, L, R, T and B, on the screen and temporarily fix it with a wedge. (Fig. 4)
3. Maintaining that situation, oscillate the deflecting yoke right and left and set the convergence of points, L, R, T and B, on the screen. (Fig. 5)
4. Repeating 2 and 3, fix the position of the deflecting yoke with 3 wedges: so as to produce the best condition for the convergence of points L, R, T and B, on the screen. Removable paper of the double-sided adhesive tape on the wedges should be removed first, and as Fig. 6 shows, inserting the wedges in order of A and B using double-sided adhesive tape after they are firmly inserted into position.

5. After completion of static-dynamic convergence adjustment, fix the magnet lock. (At that time, center convergence might cause an aberration. If this happens, unlock it and repeat the convergence adjustment until it does not cause any aberration.)

Note 1. The double-side tape on the wedges loses adhesion once it is used. Use new tape as needed.

Note 2. When a wedge is inserted, the deflecting yoke moves slightly backward, so fix the deflecting yoke slightly forward, for the time being, prior to insertion.

Note 3. If the convergence of the points, TR, TL, BR and BL are not within the standard values, correct them with the ribbon (magnetic body). (Refer to corresponding paragraphs.)

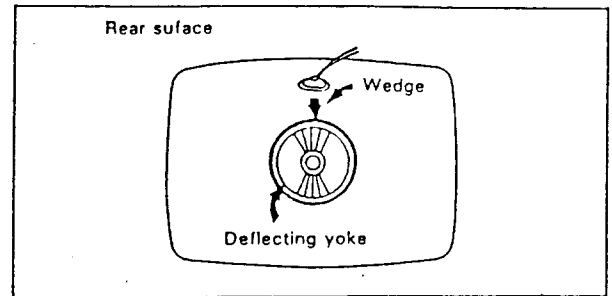

Fig. 2

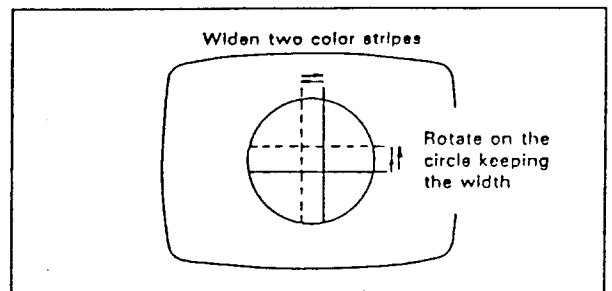

Fig. 3

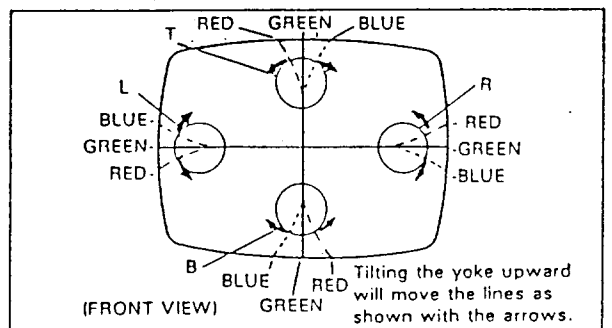

Fig. 4

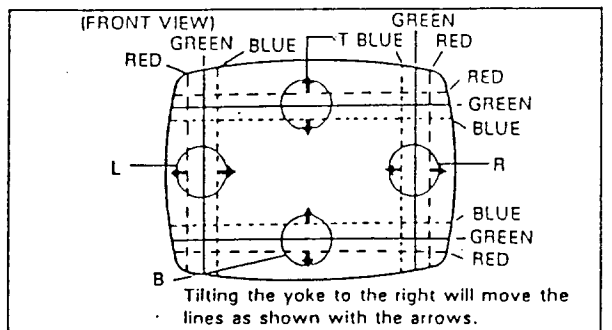

Fig. 5

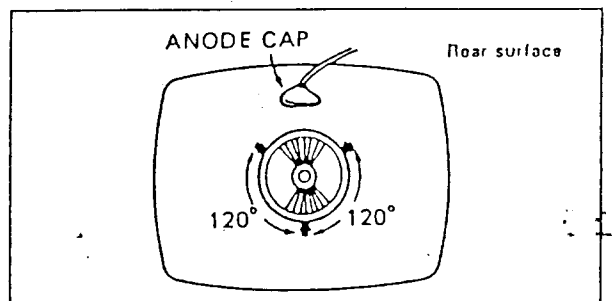

Fig. 6

■ CORRECTION MODES OF DYNAMIC (PERIPHERY) CONVERGENCE AND RIBBON (MAGNETIC MATERIAL)

- When the periphery (points TR, TL, BR, BL on the screen) convergence is nonstandardized, correct it by inserting a ribbon between the deflecting yoke and CRT funnel.
- For example, when correcting convergence of the point TR on the screen in Fig. 7, insert the ribbon in the upper-right position of the CRT facing the front.

When looking at the convergence aberration of the point TR on the screen (longitudinal and vertical line), set the position of the ribbon and correct the convergence in accordance with the following steps.

1. Moving the ribbon toward the periphery, find the position where minimum aberration of the point TR is obtained. (Fig. 8)
2. Maintaining that position, adjust the depth for inserting the ribbon and correcting the quantity of convergence in order. (Fig. 9)
3. When the position for attaching the ribbon is set, fix it with double-sided adhesive tape.

Note When the ribbon is fixed in an improper location it might cause more aberration, so ensure to fix it in the correct position.

* Part No. of the ribbon: CJ40070-00A

■ AFTER COMPLETION OF PURITY-CONVERGENCE ADJUSTMENT

1. Fasten the clamp screw of the deflecting yoke tightly.
2. Wind and fasten the magnet lock tightly.
3. Coat the PC magnet with lerchlock (Fig. 10)
 - * Lerchlock Type name No. 3-C NET 200g (Manufacturer-Raihiden Kagaku Kabushikigaisha)
4. Coat silicon on the three wedges. (Fig. 10)
 - * Silicon Type name KE4866 NET 100g (Shinetsu Kagaku)

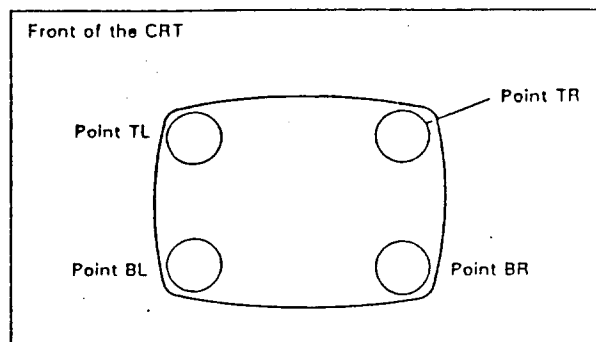

Fig. 7

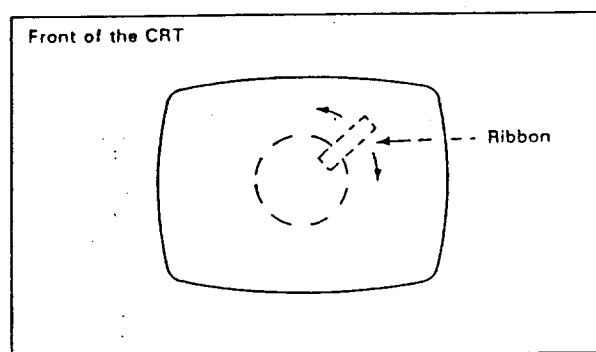

Fig. 8

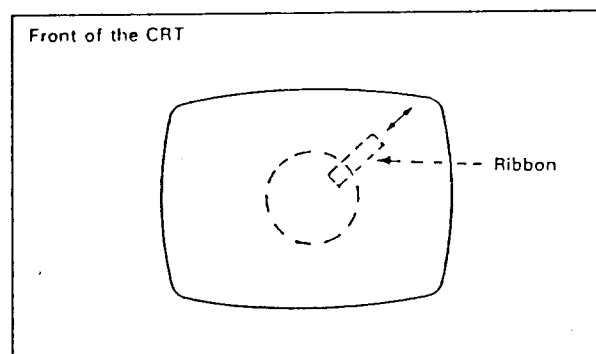

Fig. 9

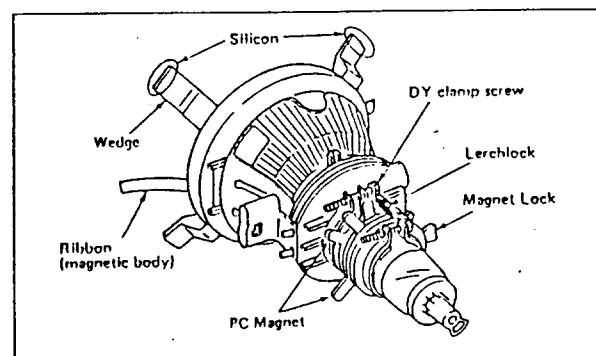

Fig. 10

REPLACEMENT PARTS LIST

PRODUCT SAFETY NOTE

Components identified by the Δ symbol in the PARTS LIST and the shaded areas on the Schematic have special characteristics important to safety. Before replacing any of these components read carefully the SAFETY PRECAUTION on Page A of this Service Manual. DO NOT degrade the safety of the set through improper servicing.

ABBREVIATED WORD OF RESISTORS AND CAPACITORS

RESISTOR

C R : Carbon Resistor
 Comp. R : Composition Resistor
 OM R : Oxide Metal Film Resistor
 V R : Variable Resistor
 MF R : Metal Film Resistor
 CMF R : Coating Metal Film Resistor
 UNF R : Unflammable Resistor

F R : Fusible Resistor
 CH MG R : Chip Metal Glaze Resistor

CAPACITOR

C Cap. : Ceramic Capacitor
 M Cap. : Mylar Capacitor
 E Cap. : Electrolytic Capacitor

BP E Cap. : Bi-Polar (or Non-Polar) Electrolytic Capacitor
 MM Cap. : Metalized Mylar Capacitor
 PP Cap. : Polypropylene Capacitor
 MPP Cap. : Metalized PP Capacitor
 PS Cap. : Polystyrol Capacitor
 Tan. Cap. : Tantal Capacitor
 CH C Cap. : Chip Ceramic Capacitor

DECODING OF TOLERANCE AND CONSTANT TERM

TOLERANCE

J: $\pm 5\%$ K: $\pm 10\%$ M: $\pm 20\%$ N: $\pm 30\%$ H: $\begin{matrix} +50\% \\ -10\% \end{matrix}$

Z: $\begin{matrix} +80\% \\ -20\% \end{matrix}$ P: $\begin{matrix} +100\% \\ -0 \end{matrix}$ R: $\begin{matrix} +30\% \\ -10\% \end{matrix}$ F: $\pm 1\%$

CONSTANT TERM

• Carbon Resistor ($\frac{1}{4}W$, $\pm 5\%$ Tolerance)

QRD141J - □ □ □

CONSTANT TERM.

- □ □ □ 2.7 Ω → QRD141J-2R7
 ↑ ↑ ↑
 1 R 0 → 1.0 Ω 47k Ω → 47 x 10³ → QRD141J-473
 ⋮ ⋮ ⋮
 9 R 7 → 9.7 Ω

1 0 □ → 10□ means 10 x 10⁰ (Ω)

⋮ ⋮ ⋮
 8 2 □ → 82□ means 82 x 10⁰ (Ω)

• Ceramic Capacitor (50 Volts, $\pm 5\%$ Tolerance)

QCS11HJ - □ □ □

CONSTANT TERM.

- □ □ □ 5pF → QCS11HJ-5R0
 ↑ ↑ ↑
 1 R 0 → 1.0pF 680pF → 68 x 10¹ → QCS11HJ-681
 ⋮ ⋮ ⋮
 8 R 0 → 8.0pF 3300pF → 33 x 10² → QCS11HJ-332

1 0 □ → 10□ means 10 x 10⁰ (pF)

⋮ ⋮ ⋮
 8 8 □ → 88□ means 88 x 10⁰ (pF)

■ CHASSIS & CABINET PARTS LIST

VIEW NO.	SYMBOL NO.	PART NO.	PART NAME	REMARKS
	1	CM1801	MA-A001A-W	SYNC IF ASSY
	2		CM32288-002	CONTROL KNOB (×2)
△	3	V01	M34JPS82X	PICTURE TUBE
△	4	T1504	CJ26891-00A	FLYBACK TRANSF.
	5		CJ30033-00A	WEDGE ASSY (×4)
	6		CE40112-00A	P/C MAGNET
△	7	DY01	CJ26903-00A	DEF YOKE
△	8	L01	CJ39691-00A	DEG. COIL
	9	J01	CH41187-009SL	D SUB 9S
△	10	NF1901	CE40811-00E	NOISE FILTER
	11		CM10765-A02-M0	BOTTOM BASE
	12	R4081	QVAA024-CB53A	V R (CONTRAST)
△	13	Q1511	2SD1959	SI. TRANSISTOR 5 KΩB
	14		CM32291-00B	FOOT (×2)
	15		CM42758-001	KNOB (×3)
△	16	SW1901	QSE4A21-C08	SEESAW SWITCH
	17		CM10764-B04-M0	REAR COVER
	18		SBSB4016N	TAP SCREW (×6)
	19	D4080	GL-5PG23	LED Power
△	20	F1901	QMF51N2-3R0S	FUSE 3.0A
	21		CM32533-001 (R)	ROLL R LABEL
	22		QVAA021-CB23A	VR (BRIGHT) 2 KΩB
	23		CH41987-00A	BRAIDED SUB ASSY (×2)
	24		CH30302-00G	BRAIDED ASSY
	100		CM11048-B0A-M0	FRONT PANEL ASSY Include No. 101-102
	101		CM44534-A01	BRAND MARK
	102		CM44437-001	LED LENS

[EXPLODED VIEW]

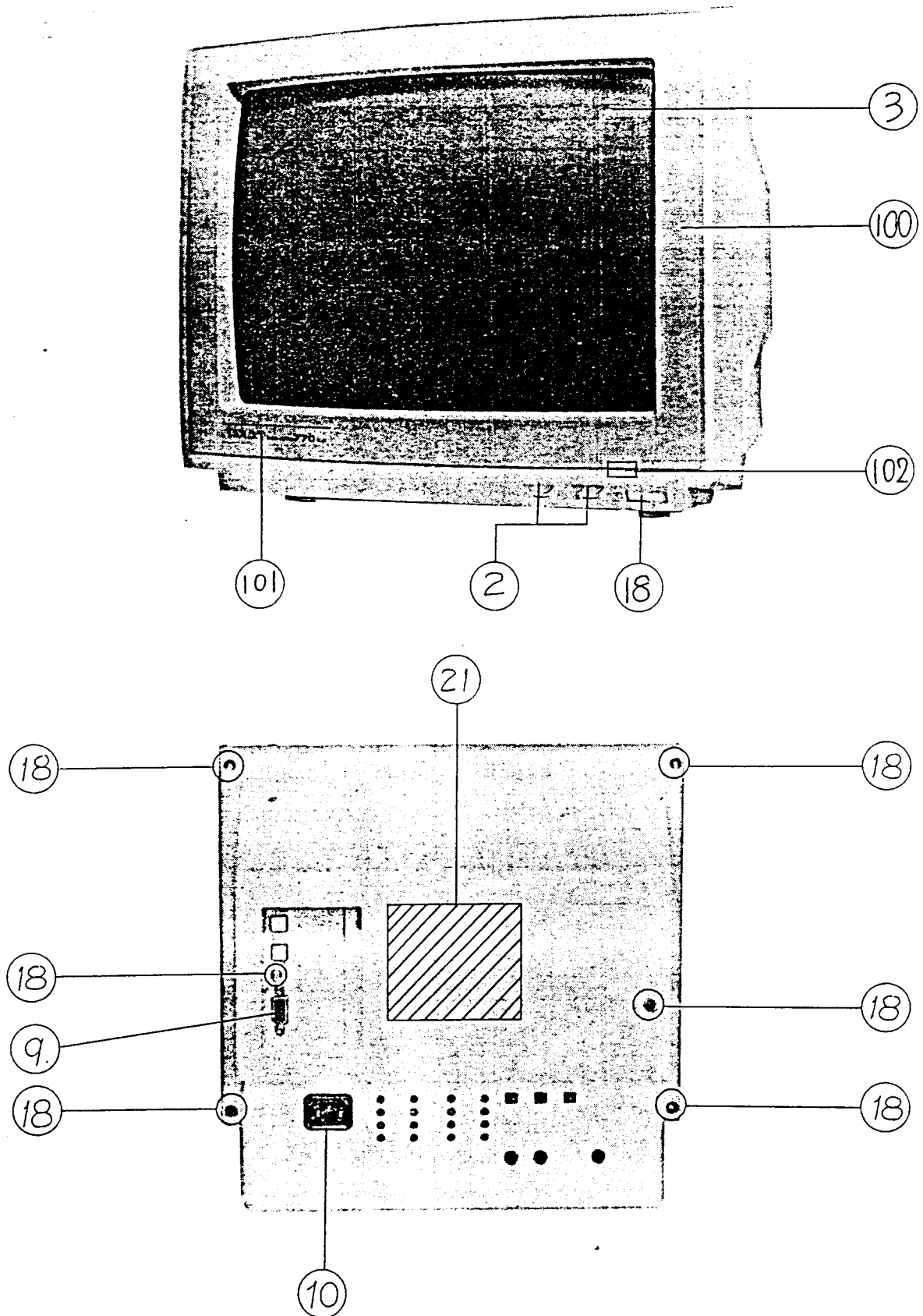

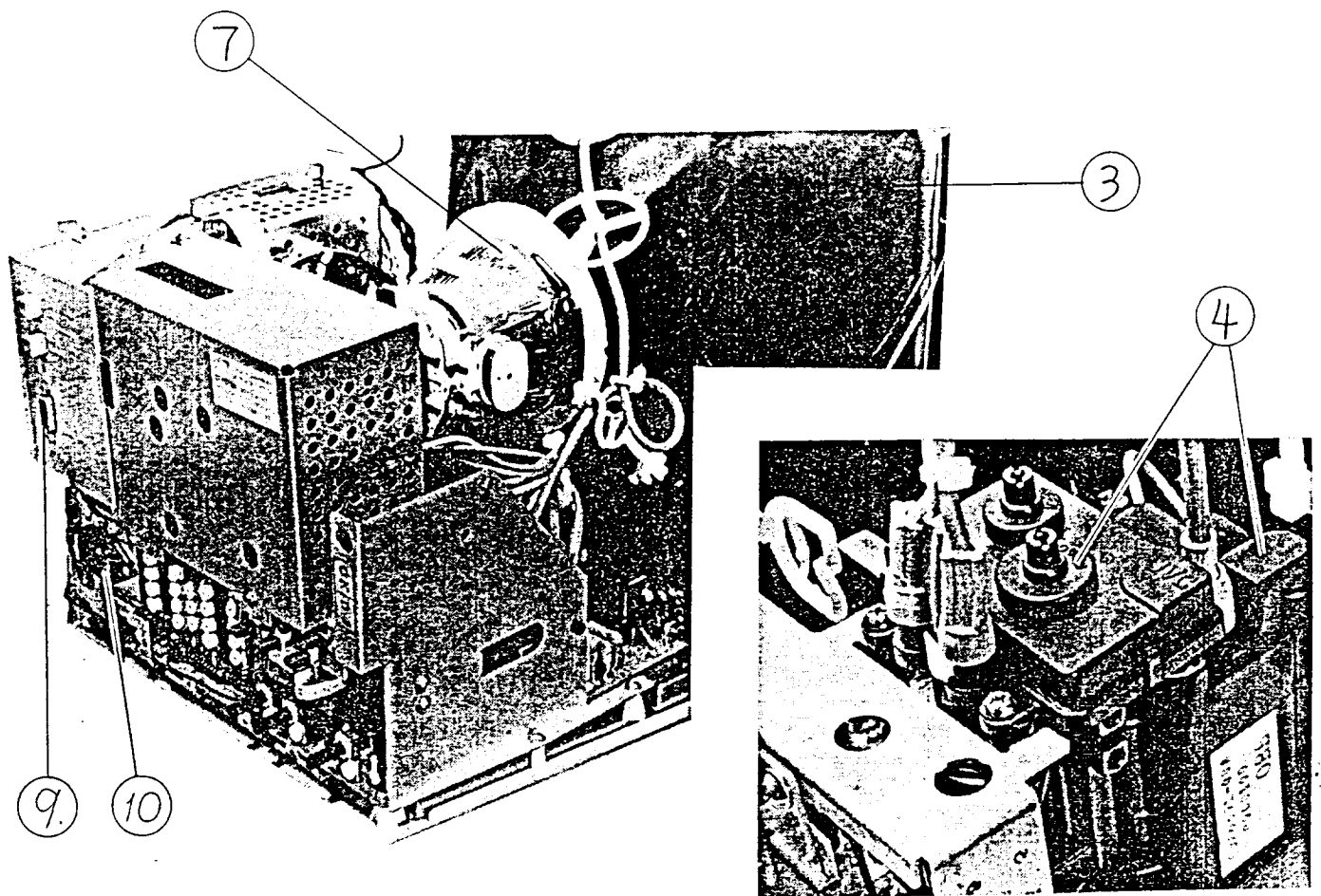
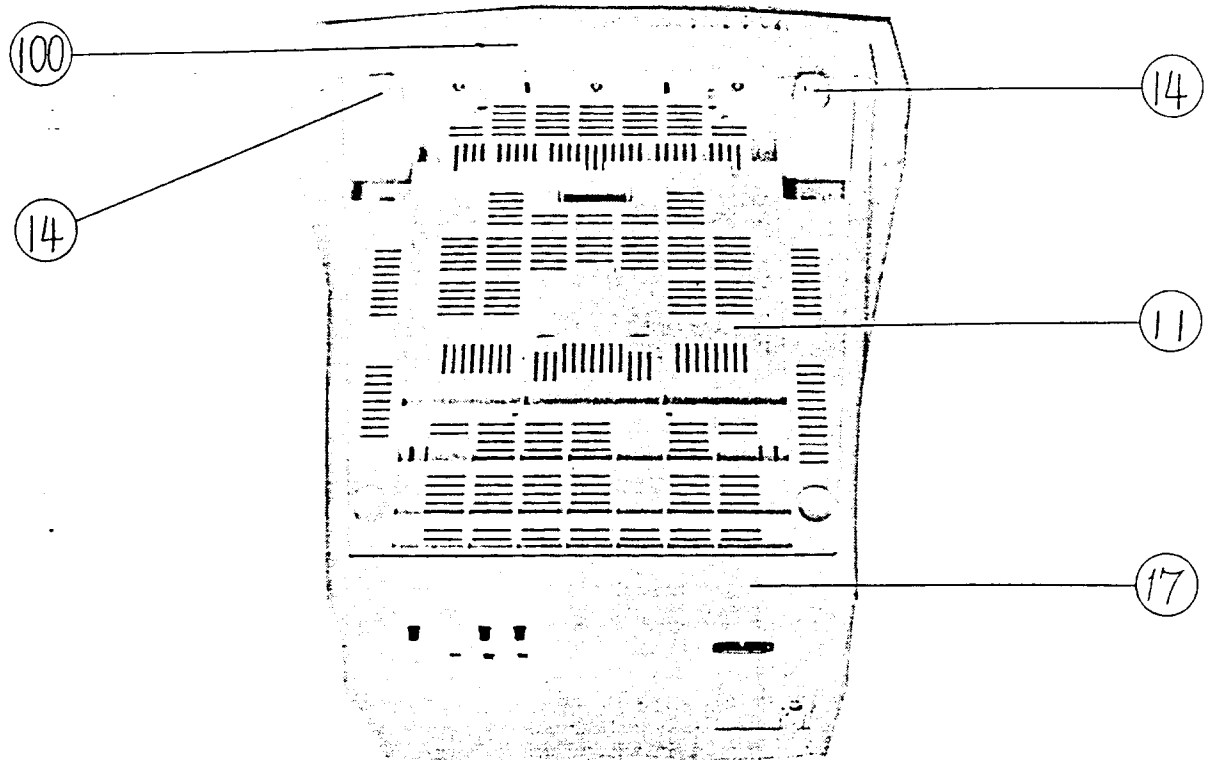

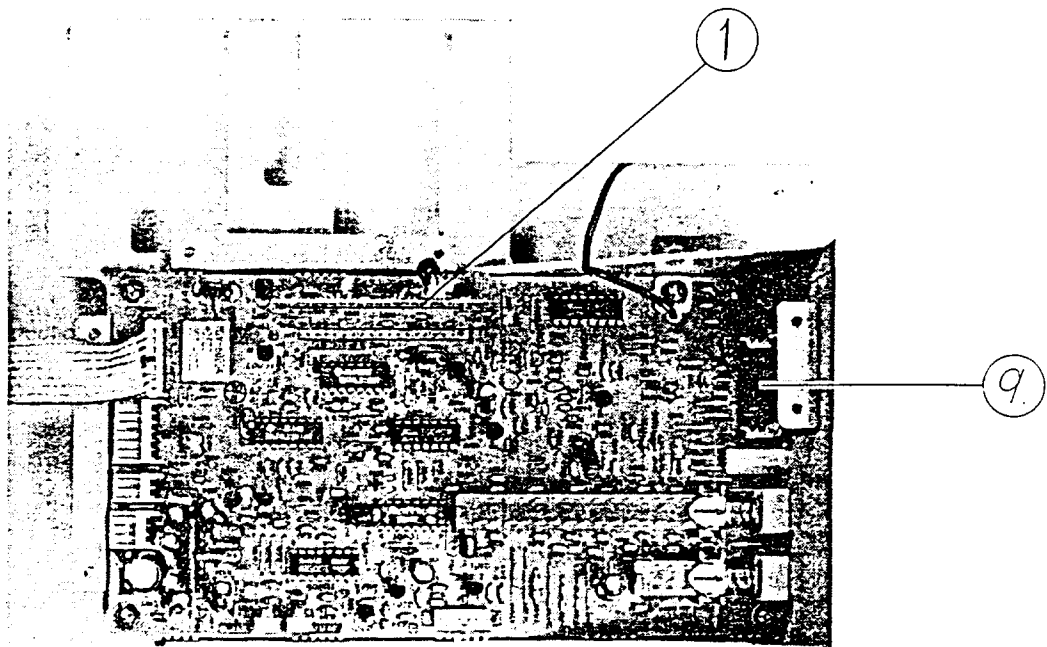
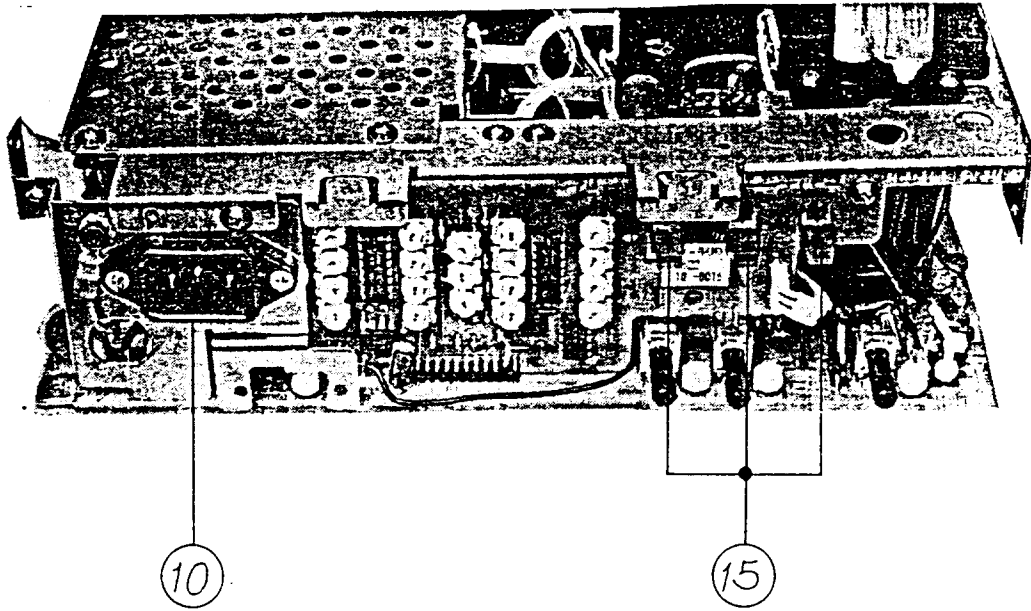

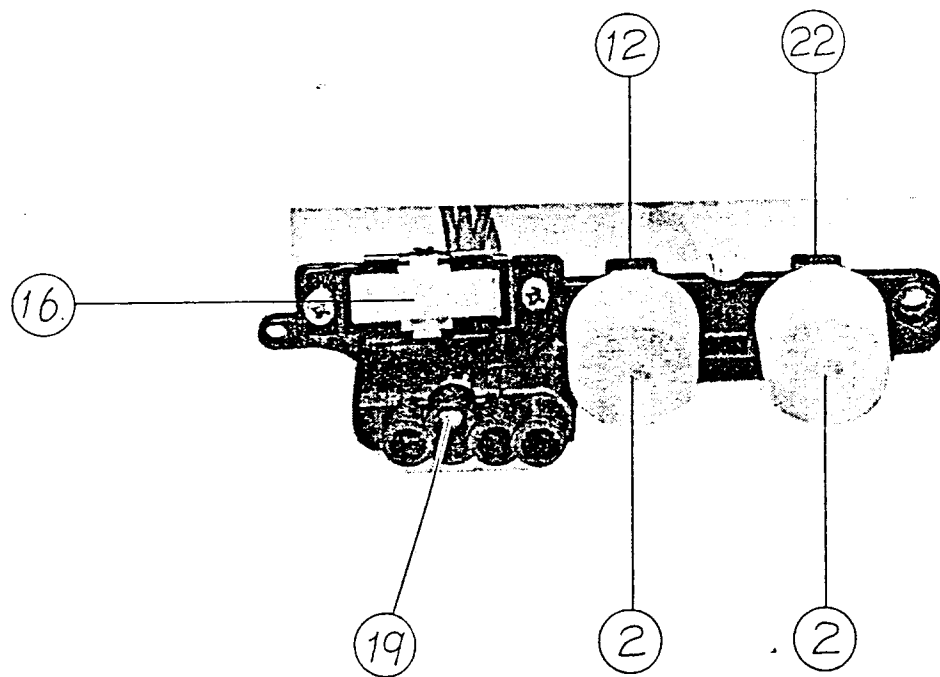
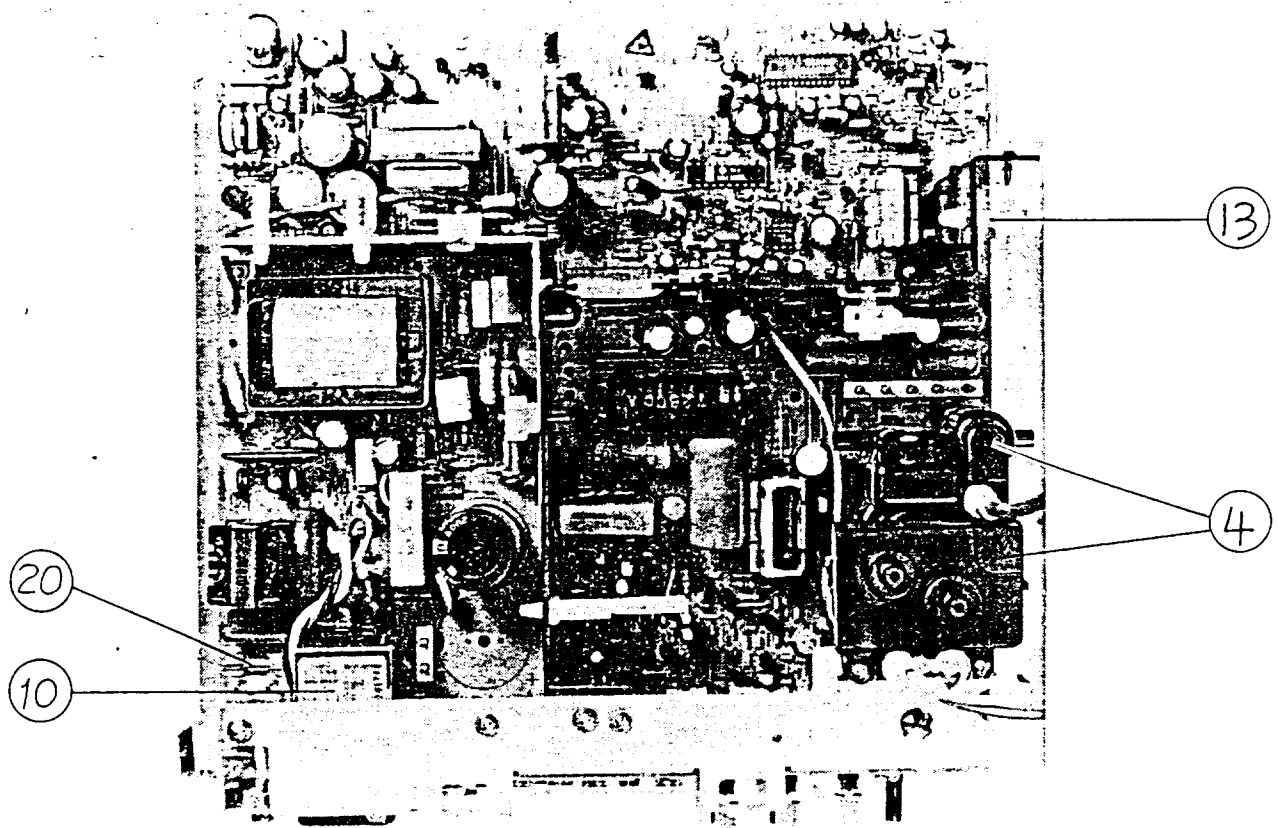

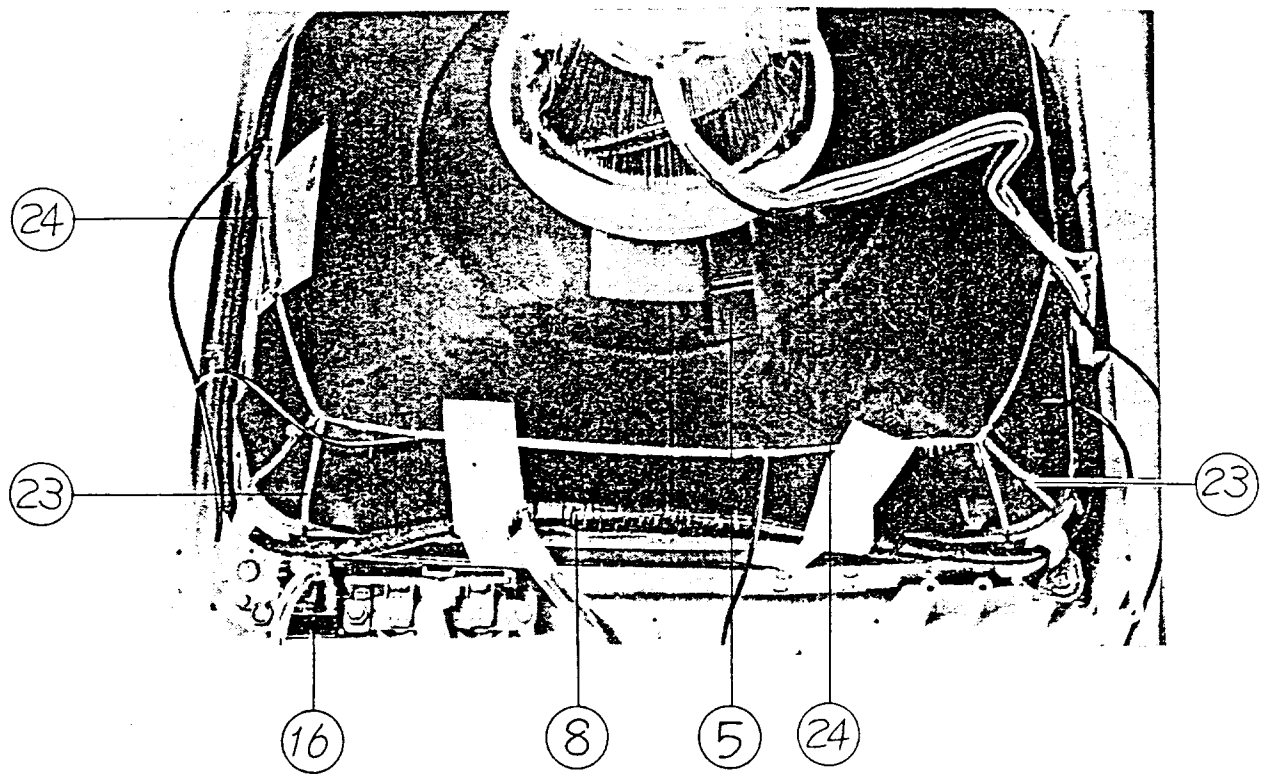
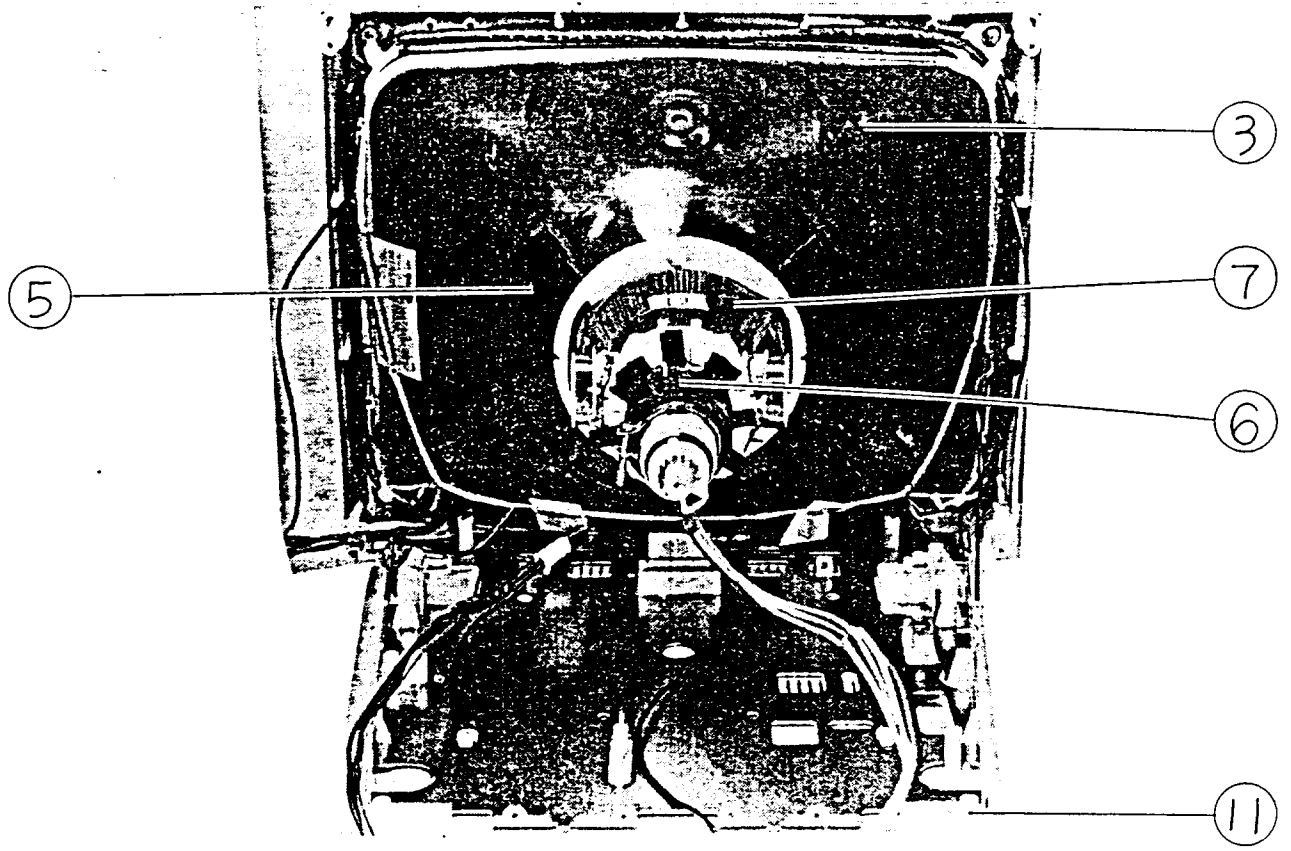

MSV-1206A (MAIN P.B. ASS'Y)

SYMBOL NO.	PART NO.	PART NAME	REMARKS
VARIABLE R			
R1007	QVPE605-102H	V R (SUB BRIGHT)	1k Ω B
R1407	QVAA002-CB24A	V R (V. SIZE)	20k Ω B
R1409	QVAA002-CB24A	V R (V. POSI)	20k Ω B
R1428	QVPE605-501H	V R (HEIGHT)	500 Ω B
R1430	QVPE605-501H	V R (V. LIN)	500 Ω B
R1446	QVPE605-502H	V R (SPCC)	5k Ω B
R1471	QVZ3211-052	V R (V. CENTER)	500 Ω B
R1511	QVAA002-CB24A	V R (H. POSI)	20k Ω B
R1521	QVPE605-503H	V R (H. FREQ)	50k Ω B
R1539	QVPE605-202H	V R (HV ADJ)	2k Ω B
R1920	QVPE605-203H	V R (B1 ADJUST)	20k Ω B
RESISTOR			
R1002	QRD161J-472Y	C R	4.7k Ω 1/6W J
R1003	QRD161J-105Y	C R	1M Ω 1/6W J
R1004	QRD161J-223Y	C R	22k Ω 1/6W J
R1008	QRD161J-222Y	C R	2.2k Ω 1/6W J
R1401	QRD161J-473Y	C R	47k Ω 1/6W J
R1402	QRD161J-562Y	C R	5.6k Ω 1/6W J
R1403	QRD161J-153Y	C R	15k Ω 1/6W J
R1404	QRD141J-823SY	C R	82k Ω 1/4W J
R1405	QRD161J-562Y	C R	5.6k Ω 1/6W J
R1406	QRD161J-104Y	C R	100k Ω 1/6W J
R1408	QRD161J-474Y	C R	470k Ω 1/6W J
R1410	QRD161J-563Y	C R	56k Ω 1/6W J
R1411	QRD161J-101Y	C R	100 Ω 1/6W J
R1412	QRD161J-104Y	C R	100k Ω 1/6W J
R1413	QRD161J-393	C R	39k Ω 1/6W J
R1414	QRD161J-103Y	C R	10k Ω 1/6W J
R1416	QRD161J-393Y	C R	39k Ω 1/6W J
R1417	QRD161J-224Y	C R	220k Ω 1/6W J
R1418	QRD161J-104Y	C R	100k Ω 1/6W J
R1419	QRD161J-104Y	C R	100k Ω 1/6W J
R1420	QRD161J-222Y	C R	2.2k Ω 1/6W J
R1421	QRD161J-473Y	C R	47k Ω 1/6W J
R1422	QRD161J-220Y	C R	22 Ω 1/6W J
R1423	QRD161J-392Y	C R	3.9k Ω 1/6W J
R1424	QRD161J-681Y	C R	680 Ω 1/6W J
R1425	QRD141J-822SY	C R	8.2k Ω 1/4W J
R1426	QRD161J-103Y	C R	10k Ω 1/6W J
R1427	QRD141J-562SY	C R	5.6k Ω 1/4W J
R1429	QRD141J-102SY	C R	1k Ω 1/4W J
R1431	QRD161J-183Y	C R	18k Ω 1/6W J
R1432	QRD161J-473Y	C R	47k Ω 1/6W J
R1435	QRD161J-224Y	C R	220k Ω 1/6W J
R1436	QRD161J-474Y	C R	470k Ω 1/6W J
R1437	QRD161J-183Y	C R	18k Ω 1/6W J
R1438	QRD161J-103Y	C R	10k Ω 1/6W J
R1439	QRD161J-101Y	C R	100 Ω 1/6W J
R1440	QRD121J-2R2SY	C R	2.2 Ω 1/2W J
R1441	QRD121J-271SY	C R	270 Ω 1/2W J
R1442	QRD161J-332Y	C R	3.3k Ω 1/6W J
R1443	QRD161J-101Y	C R	100 Ω 1/6W J
R1444	QRD161J-393Y	C R	39k Ω 1/6W J
R1445	QRD161J-560Y	C R	56 Ω 1/6W J
R1447	QRD161J-271Y	C R	270 Ω 1/6W J
R1449	QRD161J-472Y	C R	4.7k Ω 1/6W J
R1450	QRD161J-393Y	C R	39k Ω 1/6W J
R1451	QRD161J-683Y	C R	68k Ω 1/6W J

MSV-1206A

SYMBOL NO.	PART NO.	PART NAME	REMARKS
RESISTOR			
R1452	QRD161J-104Y	C R	100kΩ 1/6W J
R1453	QRD161J-154Y	C R	150kΩ 1/6W J
R1454	QRD161J-105Y	C R	1MΩ 1/6W J
R1455	QRD161J-393Y	C R	39kΩ 1/6W J
R1456	QRD161J-103Y	C R	10kΩ 1/6W J
R1457	QRD161J-560Y	C R	56 Ω 1/6W J
R1458	QRD161J-103Y	C R	10kΩ 1/6W J
R1459	QRD161J-392Y	C R	3.9kΩ 1/6W J
R1460	QRD161J-222Y	C R	2.2kΩ 1/6W J
R1461	QRD161J-682Y	C R	6.8kΩ 1/6W J
R1462	QRD161J-471Y	C R	470 Ω 1/6W J
R1463	QRD161J-222Y	C R	2.2kΩ 1/6W J
R1464	QRD161J-221Y	C R	220 Ω 1/6W J
R1469	QRD143J-471SX	C R	470 Ω 1/4W J
R1470	QRD143J-471SX	C R	470 Ω 1/4W J
R1472	QRD161J-154Y	C R	150kΩ 1/6W J
R1473	QRD161J-333Y	C R	33kΩ 1/6W J
R1475	QRD161J-104Y	C R	100kΩ 1/6W J
R1476	QRD161J-152	C R	1.5kΩ 1/6W J
R1501	QRD141J-102SY	C R	1kΩ 1/4W J
R1502	QRD141J-103SY	C R	10kΩ 1/4W J
R1503	QRD161J-273Y	C R	27kΩ 1/6W J
R1504	QRD161J-562Y	C R	5.6kΩ 1/6W J
R1505	QRD143J-331S	C R	330 Ω 1/4W J
R1506	QRD161J-472	C R	4.7kΩ 1/6W J
R1507	QRD161J-223Y	C R	22kΩ 1/6W J
R1508	QRD161J-223Y	C R	22kΩ 1/6W J
R1509	QRD161J-474Y	C R	470kΩ 1/6W J
R1510	QRD161J-474Y	C R	470kΩ 1/6W J
R1512	QRD161J-103Y	C R	10kΩ 1/6W J
R1513	QRD121J-152SY	C R	1.5kΩ 1/2W J
R1514	QRD161J-153Y	C R	15kΩ 1/6W J
R1515	QRD161J-472Y	C R	4.7kΩ 1/6W J
R1516	QRD161J-103Y	C R	10kΩ 1/6W J
R1517	QRD161J-153Y	C R	15kΩ 1/6W J
R1518	QRD161J-223Y	C R	22kΩ 1/6W J
R1519	QRD161J-103Y	C R	10kΩ 1/6W J
R1520	QRD161J-103Y	C R	10kΩ 1/6W J
R1522	QRD161J-683Y	C R	68kΩ 1/6W J
R1523	QRD161J-222Y	C R	2.2kΩ 1/6W J
R1524	QRD161J-182Y	C R	1.8kΩ 1/6W J
R1525	QRD161J-682Y	C R	6.8kΩ 1/6W J
R1526	QRD161J-683Y	C R	68kΩ 1/6W J
R1527	QRD141J-470S	C R	47 Ω 1/4W J
R1528	QRD161J-472Y	C R	4.7kΩ 1/6W J
R1529	QRD141J-223SY	C R	22kΩ 1/4W J
R1530	QRD161J-822Y	C R	8.2kΩ 1/6W J
R1531	QRD161J-222Y	C R	2.2kΩ 1/6W J
R1532	QRD161J-332Y	C R	3.3kΩ 1/6W J
R1533	QRD161J-102Y	C R	1kΩ 1/6W J
R1534	QRD141J-224SY	C R	220kΩ 1/4W J
R1535	QRD161J-272Y	C R	2.7kΩ 1/6W J
R1536	QRD161J-272Y	C R	2.7kΩ 1/6W J
R1537	QRD162J-472	C R	4.7kΩ 1/6W J
R1538	QRD161J-682Y	C R	6.8kΩ 1/6W J
R1540	QRV141F-5901Y	MF R	5.9kΩ 1/4W F
R1541	QRV141F-6802Y	MF R	68kΩ 1/4W F
R1542	QRD141J-183SY	C R	18kΩ 1/4W J

MSV-1206A

SYMBOL NO.	PART NO.	PART NAME	REMARKS		
RESISTOR					
R1543	QRD161J-103Y	C R	10k Ω	1/6W	J
R1544	QRX019J-R68S	MF R	0.68 Ω	1W	J
R1545	QRG019J-470S	OM R	47 Ω	1W	J
R1546	QRD123J-270SX	C R	27 Ω	1/2W	J
R1547	QRD141J-221SY	C R	220 Ω	1/4W	J
R1548	QRD161J-223Y	C R	22k Ω	1/6W	J
R1549	QRD161J-332Y	C R	3.3k Ω	1/6W	J
R1550	QRD121J-561SY	C R	560 Ω	1/2W	J
R1551	QRD161J-223Y	C R	22k Ω	1/6W	J
R1552	QRD161J-152Y	C R	1.5k Ω	1/6W	J
R1553	QRD161J-102Y	C R	1k Ω	1/6W	J
R1554	QRD161J-151Y	C R	150 Ω	1/6W	J
R1555	QRD141J-561SY	C R	560 Ω	1/4W	J
R1556	QRG029J-471	OM R	470 Ω	2W	J
R1557	QRD122J-560S	C R	56 Ω	1/2W	J
R1558	QRD161J-123Y	C R	12k Ω	1/6W	J
R1559	QRD161J-392Y	C R	3.9k Ω	1/6W	J
R1560	QRD161J-272Y	C R	2.7k Ω	1/6W	J
R1561	QRD161J-102	C R	1k Ω	1/6W	J
R1562	QRD161J-272Y	C R	2.7k Ω	1/6W	J
R1563	QRD161J-224Y	C R	220k Ω	1/6W	J
R1564	QRD161J-682Y	C R	6.8k Ω	1/6W	J
R1565	QRD121J-820SY	C R	82 Ω	1/2W	J
R1566	QRD121J-680SY	C R	68 Ω	1/2W	J
R1567	QRD161J-224Y	C R	220k Ω	1/6W	J
R1568	QRD162J-682	C R	6.8k Ω	1/6W	J
R1569	QRD162J-152	C R	1.5k Ω	1/6W	J
R1570	QRD162J-271	C R	270 Ω	1/6W	J
R1571	QRD161J-271Y	C R	270 Ω	1/6W	J
R1572	QRG019J-391S	OM R	390 Ω	1W	J
R1573	QRD161J-470	C R	47 Ω	1/6W	J
R1574	QRG036J-152	OM R	1.5k Ω	3W	J
R1575	QRD161J-470Y	C R	47 Ω	1/6W	J
R1576	QRD162J-333	C R	33k Ω	1/6W	J
R1577	QRD161J-333Y	C R	33k Ω	1/6W	J
R1578	QRD121J-470SY	C R	47 Ω	1/2W	J
R1579	QRD121J-150SY	C R	15 Ω	1/2W	J
R1580	QRD161J-124Y	C R	120k Ω	1/6W	J
R1581	QRD141J-101SY	C R	100 Ω	1/4W	J
R1582	QRX019J-8R2	MF R	8.2 Ω	1W	J
R1583	QRD141J-101SY	C R	100 Ω	1/4W	J
R1584	QRD161J-222Y	C R	2.2k Ω	1/6W	J
R1585	QRD161J-123Y	C R	12k Ω	1/6W	J
R1902	QRG039J-473A	OM R	47k Ω	3W	J
R1904	QRZ0079-8R2	UNF R	8.2 Ω	7W	K
R1905	QRM055K-R22	MP R	0.22 Ω	5W	K
R1906	QRM055K-R47	MP R	0.47 Ω	5W	K
R1907	QRD121J-124SY	C R	120k Ω	1/2W	J
R1908	QRC122K-104	COMP. R	100k Ω	1/2W	K
R1909	QRD121J-104SY	C R	100k Ω	1/2W	J
R1910	QRD121J-104SY	C R	100k Ω	1/2W	J
R1911	QRZ0069-103	UNF R	10k Ω	5W	K
R1912	QRD161J-103Y	C R	10k Ω	1/6W	J
R1913	QRG029J-220A	OM R	22 Ω	2W	J
R1915	QRD161J-472Y	C R	4.7k Ω	1/6W	J
R1916	QRD161J-392Y	C R	3.9k Ω	1/6W	J
R1917	QRD161J-102Y	C R	1k Ω	1/6W	J
R1918	QRV141F-2702AY	MF R	27k Ω	1/4W	F

MSV-1206A

SYMBOL NO.	PART NO.	PART NAME	REMARKS		
RESISTOR					
R1921	QRD121J-124SY	C R	120k Ω	1/2W	J
R1922	QRC122K-104	COMP. R	100k Ω	1/2W	K
R1924	QRV141F-5601AY	MF R	5.6k Ω	1/4W	F
R1925	QRD161J-1R0Y	C R	1.0 Ω	1/6W	J
R1926	QRD161J-1R0Y	C R	1.0 Ω	1/6W	J
R1927	QRD161J-223Y	C R	22k Ω	1/6W	J
R1930	QRD123J-561SX	C R	560 Ω	1/2W	J
R1931	QRD121J-102SY	C R	1k Ω	1/2W	J
R1932	QRM055K-R47	MP R	0.47 Ω	5W	K
R1934	QRD121J-273SY	C R	27k Ω	1/2W	J
CAPACITOR					
C1001	QETC1HM-335Z	E CAP.	3.3 μ F	50V	M
C1002	QETC1CM-107Z	E CAP.	100 μ F	16V	M
C1401	QFZ0083-683MZ	M CAP.	0.068 μ F	50V	K
C1407	QFV81HJ-224M	TF CAP.	0.22 μ F	50V	J
C1408	QEH51HM-474M	E CAP.	0.47 μ F	50V	M
C1409	QCY31HK-472AZ	C CAP.	4700pF	50V	K
C1410	QCS31HJ-151AZ	C CAP.	150pF	50V	J
C1411	QEHCLVM-107MZ	E CAP.	100 μ F	35V	M
C1412	QEM61EK-226MZ	E CAP.	22 μ F	25V	K
C1413	QFM71HK-183MZ	M CAP.	0.018 μ F	50V	K
C1414	QEE61VK-105BZ	TAN. CAP.	1 μ F	35V	K
C1415	QFM71HK-273MZ	M CAP.	0.027 μ F	50V	K
C1416	QETB1CM-227	E CAP.	220 μ F	16V	M
C1417	QEB61HM-104MZ	E CAP.	0.1 μ F	50V	M
C1418	QFM71HK-223MZ	M CAP.	0.022 μ F	50V	K
C1419	QEH61HM-474MZ	E CAP.	0.47 μ F	50V	M
C1420	QEN61HM-474Z	BP E CAP.	0.47 μ F	50V	M
C1421	QEHB1EM-108M	E CAP.	1000 μ F	25V	M
C1422	QFV71HJ-563MZ	TF CAP.	0.056 μ F	50V	J
C1423	QFM71HK-103M	M CAP.	0.01 μ F	50V	K
C1424	QETC1CM-107Z	E CAP.	100 μ F	16V	M
C1425	QETC1EM-226Z	E CAP.	22 μ F	25V	M
C1426	QEN61HM-105Z	BP E CAP.	1 μ F	50V	M
C1427	QETC1HM-105Z	E CAP.	1 μ F	50V	M
C1428	QCS31HJ-331AZ	C CAP.	330pF	50V	J
C1429	QEH61CM-336MZ	E CAP.	33 μ F	16V	M
C1431	QEN61HM-474Z	BP E CAP.	0.47 μ F	50V	M
C1432	QETC1HM-105Z	E CAP.	1 μ F	50V	M
C1433	QCS31HJ-681A	C CAP.	680pF	50V	J
C1435	QCS31HJ-471MZ	C CAP.	470pF	50V	J
C1436	QEH61HM-225MZ	E CAP.	2.2 μ F	50V	M
C1437	QEHB1VM-108M	E CAP.	1000 μ F	35V	M
C1501	QEN61HM-105Z	BP E CAP.	1 μ F	50V	M
C1502	QETC1HM-105Z	E CAP.	1 μ F	50V	M
C1503	QFP31HJ-152S	PP CAP.	1500pF	50V	J
C1504	QEN61HM-335Z	BP E CAP.	3.3 μ F	50V	M
C1505	QFP31HJ-102S	PP CAP.	1000pF	50V	J
C1506	QETC1CM-106Z	E CAP.	10 μ F	16V	M
C1507	QETB2CM-476	E CAP.	47 μ F	160V	M
C1508	QETC1HM-335Z	E CAP.	3.3 μ F	50V	M
C1509	QEN61HM-335Z	BP E CAP.	3.3 μ F	50V	M
C1510	QEH51HM-105M	E CAP.	1 μ F	50V	M
C1511	QETC1CM-106Z	E CAP.	10 μ F	16V	M
C1512	QFP32AG-102M	PP CAP.	1000pF	100V	G
C1513	QCS31HJ-221AZ	C CAP.	220pF	50V	J
C1514	QETC1HM-105Z	E CAP.	1 μ F	50V	M
C1515	QFM71HK-222M	M CAP.	2200pF	50V	K

MSV-1206A

SYMBOL NO.	PART NO.	PART NAME	REMARKS		
CAPACITOR					
C1516	QFP32AG-222M	PP CAP.	2200 pF	100V	G
C1517	QFM71HK-393MZ	M CAP.	0.039 μF	50V	K
C1518	QFM71HK-822MZ	M CAP.	8200 pF	50V	K
C1519	QETB1CM-107	E CAP.	100 μF	16V	M
C1520	QETB1CM-108	E CAP.	1000 μF	16V	M
C1521	QEH1CM-106MZ	E CAP.	10 μF	16V	M
C1522	QFM71HK-103MZ	M CAP.	0.01 μF	50V	K
C1523	QETC1HM-105Z	E CAP.	1 μF	50V	M
C1524	QEN61HM-474Z	BP E CAP.	0.47 μF	50V	M
C1525	QFM72AK-563M	M CAP.	0.056 μF	100V	K
C1526	QFM72AK-223M	M CAP.	0.022 μF	100V	K
C1527	QFM72AK-223M	M CAP.	0.022 μF	100V	K
C1528	QCS32HJ-151U	C CAP.	150 pF	500V	J
C1529	QETB1EM-336	E CAP.	33 μF	25V	M
C1530	QFZ0091-825S	MPP CAP.	8.2 μF	160V	K
C1531	QETC1HM-105Z	E CAP.	1 μF	50V	M
C1532	QCY32HK-471AZ	C CAP.	470 pF	500V	K
C1533	QETB2CM-107	E CAP.	100 μF	160V	M
C1534	QETA1CM-477	E CAP.	470 μF	16V	M
C1536	QETC1VM-107Z	E CAP.	100 μF	35V	M
C1537	QFM71HK-152MZ	M CAP.	1500 pF	50V	K
C1538	QFV71HJ-104MZ	TF CAP.	0.1 μF	50V	J
C1539	QCY31HK-103AZ	C CAP.	0.01 μF	50V	K
C1540	QFM72DJ-102M	M CAP.	1000 pF	200V	J
C1541	QFP42JJ-332M	PP CAP.	3300 pF	630V	J
△ C1542	QFZ0081-3101S	PP CAP.	3100 pF	1600V ±3%	
△ C1543	QFM72DK-562M	M CAP.	5600 pF	200V	K
△ C1544	QFZ0081-3801S	MPP CAP.	3800 pF	1600V ±3%	
△ C1545	QFZ0081-3701S	MPP CAP.	3700 pF	1600V ±3%	
△ C1546	QFZ0081-3501S	PP CAP.	3500 pF	1600V ±3%	
C1547	QFK52AK-224M	MM CAP.	0.22 μF	100V	K
C1548	QETC1CM-336Z	E CAP.	33 μF	16V	M
C1549	QEHB1CM-108M	E CAP.	1000 μF	16V	M
C1550	QETC1CM-227Z	E CAP.	220 μF	16V	M
C1551	QETC1HM-105Z	E CAP.	1 μF	50V	M
C1552	QETB1CM-108	E CAP.	1000 μF	16V	M
C1555	QFM11HK-103M	M CAP.	0.01 μF	50V	K
C1556	QFM11HK-103M	M CAP.	0.01 μF	50V	K
△ C1902	QFZ9022-224M	MF CAP.	0.22 μF	AC250V	M
C1903	QCZ9033-103A	C CAP.	0.01 μF	AC400V	P
△ C1904	QF79022-104M	MF CAP.	0.1 μF	AC250V	M
△ C1905	QFZ9022-224M	MF CAP.	0.22 μF	AC250V	M
△ C1906	QCZ9033-103A	C CAP.	0.01 μF	AC400V	P
△ C1907	QCZ9033-103A	C CAP.	0.01 μF	AC400V	P
C1910	QEZ0084-227R	E CAP.	220 μF	400V	M
C1911	QEZ0084-227R	E CAP.	220 μF	400V	M
C1912	QCY32HK-103A	C CAP.	0.01 μF	500V	K
C1913	QEH1AM-477MZ	E CAP.	470 μF	10V	M
C1914	QEH52CM-107M	E CAP.	100 μF	160V	M
C1915	QEHB1EM-477M	E CAP.	470 μF	25V	M
C1916	QFM71HK-332M	M CAP.	3300 pF	50V	K
C1917	QFP31HG-822S	PP CAP.	8200 pF	50V	G
C1918	QEH52CM-107M	E CAP.	100 μF	160V	M
C1919	QEH52CM-107M	E CAP.	100 μF	160V	M
C1920	QEH61HM-105MZ	E CAP.	1 μF	50V	M
C1922	QEHB1CM-108M	E CAP.	1000 μF	16V	M
C1923	QETB1VM-337	E CAP.	330 μF	35V	M
C1924	QEM61EK-226MZ	E CAP.	22 μF	25V	K

MSV-1206A

SYMBOL NO.	PART NO.	PART NAME	REMARKS
CAPACITOR			
C1925	QETB1VM-107	E CAP.	100 μ F 35V M
C1927	QEH51HM-107M	E CAP.	100 μ F 50V M
C1928	QCZ9016-102A	C CAP.	0.001 μ F AC400V K
C1929	QCZ9016-472A	C CAP.	4700pF AC400V M
C1930	QETC1AM-107Z	E CAP.	100 μ F 10V M
C1931	QEIB1EM-477M	E CAP.	470 μ F 25V M
C1932	QETB2CM-106	E CAP.	10 μ F 160V M
C1933	QCZ9016-472A	C CAP.	4700pF AC400V M
C1934	QCZ0122-331A	C CAP.	330pF 2000V K
C1935	QCZ9016-102A	C CAP.	0.001 μ F AC400V K
C1936	QCY32HK-102M	C CAP.	1000pF 500V K
C1937	QCS32HJ-221U	C CAP.	220pF 500V J
C1939	QETA1HM-105	E CAP.	1 μ F 50V M
C1940	QCZ9016-472A	C CAP.	4700pF AC400V M
TRANSFORMER			
T1501	CJ39722-00A	H DRIVE TRANSF	
T1502	CJ39721-00A	H DRIVE TRANSF	
T1503	CJ39720-00A	CHOKE TRANSF	
T1505	CE41043-00E	SIDE PIN TRANSF.	
T1506	CE41052-00A	SIDE PIN TRANS	
T1901	CE40967-00F	SW TRANSF	
COIL			
L1501	CJ39726-A0A	H LIN COIL	
L1502	CELC006-152	CHOKE COIL	
L1503	CELC002-430	CHOKE COIL	
L1901	A76186-2.2	PEAKING COIL	2.2 μ H
L1903	CELC003-3R3	CHOKE COIL	
L1905	CELC002-470	CHOKE COIL	
DIODE			
D1401	1SS133-Y	SI. DIODE	
D1402	1SS133-Y	SI. DIODE	
D1403	1SS133-Y	SI. DIODE	
D1404	1SR124-400A-Y	SI. DIODE	
D1405	1SS133-Y	SI. DIODE	
D1406	1SS133-Y	SI. DIODE	
D1407	1SS133-Y	SI. DIODE	
D1409	1SS133-Y	SI. DIODE	
D1410	05AZ75	ZENER DIODE	
D1412	1SS133-Y	SI. DIODE	
D1413	1SS133	SI. DIODE	
D1501	KU-3AM	SI. DIODE	
D1503	1SS133-Y	SI. DIODE	
D1504	HZ3LL (C)	Z DIODE	
D1505	1SS133-Y	SI. DIODE	
D1506	EG1Z	SI. DIODE	
D1507	1SS131-Y	SI. DIODE	
D1508	HZ6C1	SI DIODE	
D1509	MA4075 (M) -Y	ZENER DIODE	
D1510	HZ6C1	SI DIODE	
D1511	1SS81-Y	SI. DIODE	
D1512	1SS81-Y	SI. DIODE	
D1513	RD13E (B1)	ZENER DIODE	
D1514	1SS133-Y	SI. DIODE	
D1515	1SS133-Y	SI. DIODE	
D1516	1SS81	SI. DIODE	
D1517	RG2A	SI DIODE	
D1518	RU4DS-LFK2	SI DIODE	

MSV-1206A

SYMBOL NO.	PART NO.	PART NAME	REMARKS
DIODE			
D1519	RG2A	SI DIODE	
D1520	RU4DS-LFK2	SI DIODE	
D1521	1SS81-Y	SI DIODE	
D1522	1SS81-Y	SI DIODE	
D1523	EG1Z	SI DIODE	
D1524	1SS133	SI DIODE	
Δ D1901	TVR4N	SI DIODE	
Δ D1902	TVR4N	SI DIODE	
Δ D1903	TVR4N	SI DIODE	
Δ D1904	TVR4N	SI DIODE	
D1905	RG2A	SI DIODE	
D1906	EG1Z	SI DIODE	
D1907	MA4120 (H) -Y	ZENER DIODE	
D1908	EG1Z	SI DIODE	
D1909	EG1Z	SI DIODE	
D1910	EG1Z	SI DIODE	
D1911	RG2A	SI DIODE	
D1912	RG4C-LFK2	SI DIODE	
D1913	RL4Z-LFK2	SI DIODE	
D1914	SF5J42	THYRISTOR	
D1915	MA4068 (L)	ZENER DIODE	
D1916	RL4Z-LFK2	SI DIODE	
D1917	EG1Z	SI DIODE	
D1918	RD16E (B2)	ZENER DIODE	
D1919	EG1Z	SI DIODE	
TRANSISTOR			
Q1001	2SA1015 (O. Y) -Y	SI TRANSISTOR	
Q1003	2SC1959 (Y) -Y	SI TRANSISTOR	
Q1401	2SC1959 (Y) -Y	SI TRANSISTOR	
Q1402	2SC1959 (Y) -Y	SI TRANSISTOR	
Q1403	2SC1162 (C)	SI TRANSISTOR	
Q1404	2SC1959 (Y) -Y	SI TRANSISTOR	
Q1501	2SC1959 (Y) -Y	SI TRANSISTOR	
Q1502	2SC3336	SI TRANSISTOR	
Q1503	2SC2235 (O. Y)	SI TRANSISTOR	
Q1504	2SC1959 (Y) -Y	SI TRANSISTOR	
Q1505	2SC1627A	SI TRANSISTOR	
Q1506	2SA1015 (O. Y) -Y	SI TRANSISTOR	
Q1507	2SC1959 (Y) -Y	SI TRANSISTOR	
Q1508	2SC1627A	SI TRANSISTOR	
Q1509	2SC1959 (O) -L	SI TRANSISTOR	
Q1510	2SD1409	SI TRANSISTOR	
Δ Q1511	2SD1959	SI TRANSISTOR	H. OUT
Q1512	2SD1409	SI TRANSISTOR	
Q1513	2SC1685	SI TRANSISTOR	
Q1514	2SC1959 (Y) -Y	SI TRANSISTOR	
Q1515	2SC1959 (Y) -Y	SI TRANSISTOR	
Q1516	2SC1959 (Y)	SI TRANSISTOR	
Q1517	2SA1015 (O. Y) -Y	SI TRANSISTOR	
Q1901	2SC3461 (M)	SI TRANSISTOR	or 2SC3680
Q1902	2SD1409	SI TRANSISTOR	
Q1903	2SC1815 (O. Y) -Y	SI TRANSISTOR	
Q1904	2SC3461 (M)	SI TRANSISTOR	or 2SC3680
Q1905	2SD1409	SI TRANSISTOR	
Q1906	2SD866	SI TRANSISTOR	
IC			
IC1402	AN5515	I. C.	
IC1403	UPC4558C	I. C.	

MSV-1206A

SYMBOL NO.	PART NO.	PART NAME	REMARKS
IC			
IC1404	UPC358C	I. C.	
IC1501	M51491SP	I C	
IC1502	HA11235	I. C.	
IC1503	AN6558	I. C.	
IC1504	TA78L012AP	I. C.	
IC1505	TA78L012AP	I. C.	
Δ IC1901	SI-8100D	I. C.	
OTHERS			
CP1901	ICP-N75	IC PROTECTOR	
CP1902	ICP-N75	IC PROTECTOR	
CP1903	ICP-N75	IC PROTECTOR	
Δ F1901	QMF51N2-3R0S	FUSE	3. 0A
K1901	CE41169-002	PEAKING COIL	
K1902	CE41169-002	PEAKING COIL	
K1903	CE41169-002	PEAKING COIL	
K1904	CE41169-002	PEAKING COIL	
K1905	CE41169-003	PEAKING COIL	
Δ K1906	CE41169-002	BEADS CODE	
Δ K1907	CE41169-002	PEAKING COIL	
K1908	CE41169-003	BEADS CORE	
Δ LF1901	CE41232-00B	LINE FILTER	
RY1501	CESK003-001	RELAY	
SW1401	QSL4A13-C02	LEVER SWITCH	Service
S1501	QSL4A13-C02	LEVER SWITCH	H Center
S1502	QSL4A13-C02	LEVER SWITCH	H Center
S1503	QSL4A13-C02	LEVER SWITCH	H Center
Δ TH1901	A76038	W POSISTOR	or A76038-T

MSV-3000A (CRT SOCKET P.B. ASS'Y)

SYMBOL NO.	PART NO.	PART NAME	REMARKS
VARIABLE R			
R3102	QVPE605-103H	V R (R DRIVE)	10k Ω B
R3104	QVPE605-103H	V R (R CUT OFF)	10k Ω B
R3202	QVPE605-103H	V R (G DRIVE)	10k Ω B
R3204	QVPE605-103H	V R (G CUT OFF)	10k Ω B
R3302	QVPE605-103H	V R (B DRIVE)	10k Ω B
R3304	QVPE605-103H	V R (B CUT OFF)	10k Ω B
RESISTOR			
R3001	QRD161J-182Y	C R	1.8k Ω 1/6W J
R3002	QRD161J-102Y	C R	1k Ω 1/6W J
R3003	QRD161J-472Y	C R	4.7k Ω 1/6W J
R3004	QRD161J-102Y	C R	1k Ω 1/6W J
R3005	QRD122J-820S	C R	82 Ω 1/2W J
R3103	QRD161J-183Y	C R	18k Ω 1/6W J
R3105	QRD161J-101Y	C R	100 Ω 1/6W J
R3106	QRD161J-561Y	C R	560 Ω 1/6W J
R3107	QRD143J-101SX	C R	100 Ω 1/4W J
R3108	QRD161J-151Y	C R	150 Ω 1/6W J
R3109	QRD123J-121SX	C R	120 Ω 1/2W J
R3110	QRD161J-820Y	C R	82 Ω 1/6W J
R3111	QRD161J-122Y	C R	1.2k Ω 1/6W J
R3112	QRC029J-561A	OM R	560 Ω 2W J
R3113	QRZ0069-122	UNF. R	1.2k Ω 5W K
R3114	QRD161J-471Y	C R	470 Ω 1/6W J
R3115	QRD161J-562Y	C R	5.6k Ω 1/6W J
R3116	QRD161J-153Y	C R	15k Ω 1/6W J
R3117	QRD161J-272Y	C R	2.7k Ω 1/6W J
R3118	QRD161J-470	C R	47 Ω 1/6W J
R3181	QRC122K-271	COMP. R	270 Ω 1/2W K
R3203	QRD161J-183Y	C R	18k Ω 1/6W J
R3205	QRD161J-101Y	C R	100 Ω 1/6W J
R3206	QRD161J-561Y	C R	560 Ω 1/6W J
R3207	QRD143J-101SX	C R	100 Ω 1/4W J
R3208	QRD161J-151Y	C R	150 Ω 1/6W J
R3209	QRD123J-121SX	C R	120 Ω 1/2W J
R3210	QRD161J-470Y	C R	47 Ω 1/6W J
R3211	QRD161J-122Y	C R	1.2k Ω 1/6W J
R3212	QRC029J-561A	OM R	560 Ω 2W J
R3213	QRZ0069-122	UNF. R	1.2k Ω 5W K
R3214	QRD161J-471Y	C R	470 Ω 1/6W J
R3215	QRD161J-562Y	C R	5.6k Ω 1/6W J
R3216	QRD161J-153Y	C R	15k Ω 1/6W J
R3217	QRD161J-272Y	C R	2.7k Ω 1/6W J
R3218	QRD161J-820	C R	82 Ω 1/6W J
R3281	QRC122K-271	COMP. R	270 Ω 1/2W K
R3303	QRD161J-183Y	C R	18k Ω 1/6W J
R3305	QRD161J-101Y	C R	100 Ω 1/6W J
R3306	QRD161J-561Y	C R	560 Ω 1/6W J
R3307	QRD143J-101SX	C R	100 Ω 1/4W J
R3308	QRD161J-151Y	C R	150 Ω 1/6W J
R3309	QRD123J-121SX	C R	120 Ω 1/2W J
R3310	QRD161J-470Y	C R	47 Ω 1/6W J
R3311	QRD161J-122Y	C R	1.2k Ω 1/6W J
R3312	QRC029J-561A	OM R	560 Ω 2W J
R3313	QRZ0069-122	UNF. R	1.2k Ω 5W K
R3314	QRD162J-471	C R	470 Ω 1/6W J
R3315	QRD161J-562Y	C R	5.6k Ω 1/6W J
R3316	QRD161J-153Y	C R	15k Ω 1/6W J
R3317	QRD161J-272Y	C R	2.7k Ω 1/6W J

MSV-3000A

SYMBOL NO.	PART NO.	PART NAME	REMARKS
RESISTOR			
R3318	QRD161J-820	C R	82 Ω 1/6W J
R3381	QRC122K-271	COMP. R	270 Ω 1/2W K
R3501	QRC019J-822S	OM R	8.2kΩ 1W J
R3502	QRD161J-104Y	C R	100kΩ 1/6W J
R3503	QRD161J-102Y	C R	1kΩ 1/6W J
R3581	QRC122K-471	COMP. R	470 Ω 1/2W K
CAPACITOR			
C3001	QEHC1EM-107MZ	E CAP.	100μF 25V M
C3002	QCY31HK-103AZ	C CAP.	0.01μF 50V K
C3003	QCY31HK-222MZ	C CAP.	2200pF 50V K
C3004	QEHC1EM-107MZ	E CAP.	100μF 25V M
C3081	QEHC1EM-107MZ	E CAP.	100μF 25V M
C3101	QEN61HM-105Z	BP E CAP.	1μF 50V M
C3102	QFV41HJ-104M	TF CAP.	0.1μF 50V J
C3103	QCY31HK-102AZ	C CAP.	1000pF 50V K
C3105	QFM71HK-223MZ	M CAP.	0.022μF 50V K
C3106	QFM71HK-473MZ	M CAP.	0.047μF 50V K
C3107	QCS11HJ-181A	C CAP.	180pF 50V J
C3108	QCS31HJ-680AZ	C CAP.	68pF 50V J
C3109	QCY31HK-222MZ	C CAP.	2200pF 50V K
C3201	QEN41HM-105	BP E CAP.	1μF 50V M
C3202	QFV41HJ-104M	TF CAP.	0.1μF 50V J
C3203	QCY31HK-102AZ	C CAP.	1000pF 50V K
C3205	QFM71HK-223MZ	M CAP.	0.022μF 50V K
C3206	QFM71HK-473M	M CAP.	0.047μF 50V K
C3207	QCS11HJ-680A	C CAP.	68pF 50V J
C3208	QCS31HJ-181AZ	C CAP.	180pF 50V J
C3209	QCY31HK-222MZ	C CAP.	2200pF 50V K
C3301	QEN61HM-105Z	BP E CAP.	1μF 50V M
C3302	QFV41HJ-104M	TF CAP.	0.1μF 50V J
C3303	QCY31HK-102AZ	C CAP.	1000pF 50V K
C3305	QFM71HK-223M	M CAP.	0.022μF 50V K
C3306	QFM71HK-473MZ	M CAP.	0.047μF 50V K
C3307	QCS11HJ-680A	C CAP.	68pF 50V J
C3308	QCS31HJ-181AZ	C CAP.	180pF 50V J
C3309	QCY31HK-222MZ	C CAP.	2200pF 50V K
C3501	QFM72DK-563M	M CAP.	0.056μF 200V K
C3504	QEH52CM-336M	E CAP.	33μF 160V M
C3505	QEH52CM-105M	E CAP.	1μF 160V M
C3581	QCZ9016-103A	C CAP.	0.01μF AC400V P
COIL			
L3001	A04725-150Z	PEAKING COIL	150μH
L3101	A76186-2.7Z	PEAKING COIL	2.7μH
L3102	A76186-5.6Z	PEAKING COIL	5.6μH
L3201	A76186-2.7Z	PEAKING COIL	2.7μH
L3202	A76186-5.6Z	PEAKING COIL	5.6μH
L3301	A76186-2.7Z	PEAKING COIL	2.7μH
L3302	A76186-5.6Z	PEAKING COIL	5.6μH
L3501	A76186-1000Z	PEAKING COIL	1MH
DIODE			
D3101	RD20EB	ZENER DIODE	
D3201	RD20EB	ZENER DIODE	
D3301	RD20EB	ZENER DIODE	
D3501	1SR124-400-K	SI. DIODE	
D3502	1SR124-400-K	SI. DIODE	
D3503	1SS81	SI. DIODE	

MSV-3000A

SYMBOL NO.	PART NO.	PART NAME	REMARKS
TRANSISTOR			
Q3101	2SC1906	SI. TRANSISTOR	
Q3102	2SC3946	SI. TRANSISTOR	
Q3103	2SC1360	SI. TRANSISTOR	
Q3201	2SC1906	SI. TRANSISTOR	
Q3202	2SC3946	SI. TRANSISTOR	
Q3203	2SC1360	SI. TRANSISTOR	
Q3301	2SC1906	SI. TRANSISTOR	
Q3302	2SC3946	SI. TRANSISTOR	
Q3303	2SC1360	SI. TRANSISTOR	
Q3501	2SC1890A (E. F)	SI. TRANSISTOR	
IC			
IC3001	M51493P	I C	
IC3002	TA78L012AP	I. C.	
OTHERS			
Δ SG3101	A75522-C	CRT SOCKET	
SG3201	CE41220-301	ARRESTOR	
SG3301	CE41220-301	ARRESTOR	
SG3501	CE41220-301	ARRESTOR	

MSV-4102A (FRONT CONTROL P B ASS'Y)

SYMBOL NO.	PART NO.	PART NAME	REMARKS
VARIABLE R			
R4081	QVAA024-CB53A	V R (CONTRAST)	5k Ω B
R4086	QVAA021-CB23A	V R (BRIGHT)	2k Ω B
RESISTOR			
R4082	QRD162J-472	C R	4.7k Ω 1/6W J
R4083	QRD162J-122	C R	1.2k Ω 1/6W J
R4085	QRD161J-122	C R	1.2k Ω 1/6W J
DIODE			
D4080	GL-5PG23	L E D	Power

MSV-4001A (REAR CONTROL P B ASS'Y)

SYMBOL NO.	PART NO.	PART NAME	REMARKS
VARIABLE R			
R4001	QVPE604-203H	V R (VS)	20k Ω B
R4002	QVPE604-203H	V R (VS)	20k Ω B
R4003	QVPE604-203H	V R (VS)	20k Ω B
R4004	QVPE604-203H	V R (VS)	20k Ω B
R4005	QVPE604-203H	V R (VP)	20k Ω B
R4006	QVPE604-203H	V R (VP)	20k Ω B
R4007	QVPE604-203H	V R (VP)	20k Ω B
R4008	QVPE604-203H	V R (VP)	20k Ω B
R4009	QVPE604-203H	V R (HS)	20k Ω B
R4010	QVPE604-203H	V R (HS)	20k Ω B
R4011	QVPE604-203H	V R (HS)	20k Ω B
R4012	QVPE604-203H	V R (HS)	20k Ω B
R4013	QVPE604-203H	V R (HP)	20k Ω B
R4014	QVPE604-203H	V R (HP)	20k Ω B
R4015	QVPE604-203H	V R (HP)	20k Ω B
R4016	QVPE604-203H	V R (HP)	20k Ω B
R4018	QVPE604-203H	V R (PRESET)	20k Ω B
R4020	QVPE604-203H	V R (PRESET)	20k Ω B
R4024	QVPE604-203H	V R (PRESET)	20k Ω B
RESISTOR			
R4017	QRD161J-563Y	C R	56k Ω 1/6W J
R4019	QRD161J-103Y	C R	10k Ω 1/6W J
R4021	QRD161J-563Y	C R	56k Ω 1/6W J
R4022	QRD161J-103Y	C R	10k Ω 1/6W J
R4023	QRD161J-563Y	C R	56k Ω 1/6W J
R4025	QRD161J-223Y	C R	22k Ω 1/6W J
R4026	QRD161J-123Y	C R	12k Ω 1/6W J
R4027	QRD161J-124Y	C R	120k Ω 1/6W J
R4028	QRD161J-333Y	C R	33k Ω 1/6W J
R4029	QRD161J-151Y	C R	150 Ω 1/6W J
R4030	QRD161J-104Y	C R	100k Ω 1/6W J
R4031	QRD161J-102Y	C R	1k Ω 1/6W J
R4032	QRD161J-102Y	C R	1k Ω 1/6W J
R4033	QRD161J-102Y	C R	1k Ω 1/6W J
R4034	QRD161J-124Y	C R	120k Ω 1/6W J
R4035	QRD161J-102Y	C R	1k Ω 1/6W J
R4036	QRD161J-104Y	C R	100k Ω 1/6W J
R4037	QRD161J-103Y	C R	10k Ω 1/6W J
R4038	QRD161J-223Y	C R	22k Ω 1/6W J
R4039	QRD161J-333Y	C R	33k Ω 1/6W J
R4040	QRD161J-103Y	C R	10k Ω 1/6W J
R4041	QRD161J-183Y	C R	18k Ω 1/6W J
R4042	QRD161J-103Y	C R	10k Ω 1/6W J
R4043	QRD161J-333	C R	33k Ω 1/6W J
R4044	QRD161J-103Y	C R	10k Ω 1/6W J
DIODE			
D4001	1SS133-Y	SI. DIODE	
D4002	RD5. 6E (B2)	ZENER DIODE	
D4003	1SS133-Y	SI. DIODE	
D4004	1SS133-Y	SI. DIODE	
D4005	1SS133-Y	SI. DIODE	
D4006	RD4. 3ES (B2)	ZENER DIODE	
TRANSISTOR			
Q4001	2SD637 (R. S)	SI. TRANSISTOR	
IC			
IC4001	TC4052BP	I. C.	
IC4002	TC4052BP	I. C.	
IC4003	UPC4558	I. C.	
IC4004	UPC4558	I. C.	
OTHERS			
SW4001	QSP2C22-C01	PUSH SWITCH	Preset Cancel
SW4002	QSP2C22-C01	PUSH SWITCH	Over Scan
SW4003	QSP2C22-C01	PUSH SWITCH	Colors

MSV-6000A (INPUT P.B. ASS'Y)

SYMBOL NO.	PART NO.	PART NAME	REMARKS
VARIABLE R			
R6109	QVPE605-102H	V R (TTL RED LEVE L)	1k Ω B
R6309	QVPE605-102H	V R (TTL BLUE LEV EL)	1k Ω B
RESISTOR			
R6001	QRD161J-561Y	C R	560 Ω 1/6W J
R6002	QRD161J-333Y	C R	33k Ω 1/6W J
R6003	QRD161J-123Y	C R	12k Ω 1/6W J
R6005	QRD161J-331Y	C R	330 Ω 1/6W J
R6006	QRD161J-331Y	C R	330 Ω 1/6W J
R6007	QRD161J-331Y	C R	330 Ω 1/6W J
R6008	QRD161J-681Y	C R	680 Ω 1/6W J
R6009	QRD161J-681Y	C R	680 Ω 1/6W J
R6010	QRD161J-681Y	C R	680 Ω 1/6W J
R6021	QRD161J-562Y	C R	5.6k Ω 1/6W J
R6022	QRD161J-562Y	C R	5.6k Ω 1/6W J
R6023	QRD161J-103Y	C R	10k Ω 1/6W J
R6024	QRD161J-562Y	C R	5.6k Ω 1/6W J
R6027	QRD161J-823Y	C R	82k Ω 1/6W J
R6028	QRD161J-221Y	C R	220 Ω 1/6W J
R6029	QRD161J-332Y	C R	3.3k Ω 1/6W J
R6030	QRD161J-682Y	C R	6.8k Ω 1/6W J
R6031	QRD161J-103Y	C R	10k Ω 1/6W J
R6032	QRD161J-102	C R	1k Ω 1/6W J
R6101	QRD161J-123	C R	12k Ω 1/6W J
R6102	QRV141F-75R0AY	MF R	75 Ω 1/4W F
R6103	QRD161J-331Y	C R	330 Ω 1/6W J
R6104	QRD161J-221Y	C R	220 Ω 1/6W J
R6105	QRD161J-331Y	C R	330 Ω 1/6W J
R6106	QRD161J-221Y	C R	220 Ω 1/6W J
R6107	QRD161J-182Y	C R	1.8k Ω 1/6W J
R6108	QRD161J-332Y	C R	3.3k Ω 1/6W J
R6110	QRD161J-681Y	C R	680 Ω 1/6W J
R6111	QRD161J-394Y	C R	390k Ω 1/6W J
R6112	QRD161J-333Y	C R	33k Ω 1/6W J
R6113	QRD161J-331	C R	330 Ω 1/6W J
R6114	QRD161J-104Y	C R	100k Ω 1/6W J
R6115	QRD161J-332Y	C R	3.3k Ω 1/6W J
R6116	QRD161J-472Y	C R	4.7k Ω 1/6W J
R6118	QRD161J-680Y	C R	68 Ω 1/6W J
R6201	QRD161J-123	C R	12k Ω 1/6W J
R6202	QRV141F-75R0AY	MF R	75 Ω 1/4W F
R6203	QRD161J-331Y	C R	330 Ω 1/6W J
R6204	QRD161J-221Y	C R	220 Ω 1/6W J
R6205	QRD161J-331Y	C R	330 Ω 1/6W J
R6206	QRD161J-221Y	C R	220 Ω 1/6W J
R6207	QRD161J-102Y	C R	1k Ω 1/6W J
R6208	QRD161J-271Y	C R	270 Ω 1/6W J
R6209	QRD141J-821SY	C R	820 Ω 1/4W J
R6210	QRD161J-332Y	C R	3.3k Ω 1/6W J
R6211	QRD161J-331Y	C R	330 Ω 1/6W J
R6212	QRD161J-394Y	C R	390k Ω 1/6W J
R6213	QRD161J-333Y	C R	33k Ω 1/6W J
R6215	QRD161J-104Y	C R	100k Ω 1/6W J
R6216	QRD161J-332Y	C R	3.3k Ω 1/6W J
R6218	QRD161J-680Y	C R	68 Ω 1/6W J
R6301	QRD161J-123	C R	12k Ω 1/6W J
R6302	QRV141F-75R0AY	MF R	75 Ω 1/4W F
R6303	QRD161J-331Y	C R	330 Ω 1/6W J
R6304	QRD161J-221Y	C R	220 Ω 1/6W J

MSV-6000A



SYMBOL NO.	PART NO.	PART NAME	REMARKS		
RESISTOR					
R6305	QRD161J-331Y	C R	330 Ω	1/6W	J
R6306	QRD141J-221SY	C R	220 Ω	1/4W	J
R6307	QRD161J-182Y	C R	1.8k Ω	1/6W	J
R6308	QRD161J-332Y	C R	3.3k Ω	1/6W	J
R6310	QRD161J-681Y	C R	680 Ω	1/6W	J
R6311	QRD161J-394Y	C R	390k Ω	1/6W	J
R6312	QRD161J-333Y	C R	33k Ω	1/6W	J
R6313	QRD161J-331	C R	330 Ω	1/6W	J
R6314	QRD161J-104Y	C R	100k Ω	1/6W	J
R6315	QRD161J-332Y	C R	3.3k Ω	1/6W	J
R6316	QRD161J-472Y	C R	4.7k Ω	1/6W	J
R6318	QRD161J-680Y	C R	68 Ω	1/6W	J
R6410	QRD161J-223Y	C R	22k Ω	1/6W	J
R6411	QRD161J-223Y	C R	22k Ω	1/6W	J
R6412	QRD161J-474Y	C R	470k Ω	1/6W	J
R6413	QRD161J-223Y	C R	22k Ω	1/6W	J
R6466	QRD161J-103Y	C R	10k Ω	1/6W	J
R6474	QRD161J-334Y	C R	330k Ω	1/6W	J
R6476	QRD161J-102Y	C R	1k Ω	1/6W	J
CAPACITOR					
C6001	QETC1CM-106Z	E CAP.	10 μ F	16V	M
C6003	QET61ER-475Z	E CAP.	4.7 μ F	25V	R
C6005	QETC1CM-227Z	E CAP.	220 μ F	16V	M
C6006	QETC1AM-476Z	E CAP.	47 μ F	10V	M
C6007	QFV81HJ-104M	TF CAP.	0.1 μ F	50V	J
C6008	QFV81HJ-104M	TF CAP.	0.1 μ F	50V	J
C6009	QFV81HJ-104M	TF CAP.	0.1 μ F	50V	J
C6010	QETA1EM-336	E CAP.	33 μ F	25V	M
C6101	QEN61HM-475Z	BP E CAP.	4.7 μ F	50V	M
C6201	QEN61HM-475Z	BP E CAP.	4.7 μ F	50V	M
C6301	QEN61HM-475Z	BP E CAP.	4.7 μ F	50V	M
C6401	QEN61HM-105Z	BP E CAP.	1 μ F	50V	M
C6402	QETC1HM-105Z	E CAP.	1 μ F	50V	M
C6403	QFV71HJ-474MZ	TF CAP.	0.47 μ F	50V	J
C6404	QEN61HM-335Z	BP E CAP.	3.3 μ F	50V	M
C6405	QFV71HJ-224MZ	TF CAP.	0.22 μ F	50V	J
C6406	QETC1CM-106Z	E CAP.	10 μ F	16V	M
C6407	QETC1CM-106Z	E CAP.	10 μ F	16V	M
C6430	QFM71HJ-152MZ	M CAP.	1500pF	50V	J
C6434	QETC1HM-105Z	E CAP.	1 μ F	50V	M
C6438	QETA1CM-477	E CAP.	470 μ F	16V	M
COIL					
L6401	A76186-1000Z	PEAKING COIL	1MH		
DIODE					
D6001	RD9.1JS (B3) -Y	ZENER DIODE			
D6002	RD9.1JS (B3) -Y	ZENER DIODE			
D6003	RD9.1JS (B3) -Y	ZENER DIODE			
D6004	RD9.1JS (B3) -Y	ZENER DIODE			
D6005	RD9.1JS (B3) -Y	ZENER DIODE			
D6006	RD9.1JS (B3) -Y	ZENER DIODE			
D6007	RD9.1JS (B3) -Y	ZENER DIODE			
D6008	RD9.1JS (B3) -Y	ZENER DIODE			
D6009	RD9.1JS (B3) -Y	ZENER DIODE			
D6011	1SS133-Y	SI. DIODE			
D6201	1SS133-Y	SI. DIODE			
D6401	MA4062 (M) -Y	ZENER DIODE			

MSV-6000A

SYMBOL NO.	PART NO.	PART NAME	REMARKS
TRANSISTOR			
Q6001	2SC1959 (Y) -Y	SI. TRANSISTOR	
Q6005	2SC1959 (Y) -Y	SI. TRANSISTOR	
Q6006	2SC1959 (Y) -Y	SI. TRANSISTOR	
Q6007	2SC1959 (Y) -Y	SI. TRANSISTOR	
Q6008	2SC1959 (Y) -Y	SI. TRANSISTOR	
Q6101	2SA1015 (O. Y) -Y	SI. TRANSISTOR	
Q6201	2SA1015 (O. Y) -Y	SI. TRANSISTOR	
Q6301	2SA1015 (O. Y) -Y	SI. TRANSISTOR	
IC			
IC6001	SN74LS367AN	I. C. (M)	
IC6002	TC4066BP	I. C.	
IC6003	SN74LS138N	I. C. (M)	
IC6004	SN74LS367AN	I. C. (M)	
IC6005	TC4053BP	I. C.	
IC6006	TC4053BP	I. C.	
IC6007	TA78L012AP	I. C.	
IC6401	M51492L	I C	
OTHERS			
J01	CH41187-009SL	D SUB 9S	
SW6001	QST1101-C04	PUSH SWITCH	TTL/Analog Input
SW6002	QST1101-C03	PUSH SWITCH	Color/Mono

SCHEMATIC DIAGRAM MODEL SV-775 E

■ SAFETY PRECAUTIONS

- The FR () is a fusible resistor, thus possessing the function of a fuse. When replacing their fusible resistor or the safety-indicated parts () shown in the circuit diagrams, be sure to use correctly designated parts for safety.
Also, to ensure safety and maintenance of designated performance, also use the specified items on other components.

■ INDICATED VOLTAGE AND WAVEFORMS

- Voltage/waveforms on respective components are indicated by actually measuring them with a tester or an oscilloscope through display color bar signals of sufficient sensitivity. The volume positions are set as a result of measurement under the condition of factory shipment. Since the signal systems present slightly fluctuating values depending on adjustment and other conditions, the indicated values should be used as reference values. All indicated values represent DC voltage.

Tester used for measuring

Internal resistance DC 20 k Ω /V

Oscilloscope sweeping time

H \rightarrow 20 μ S/div

V \rightarrow 5 mS/div

Others \rightarrow Sweeping time is indicated

■ CIRCUIT DIAGRAM DISPLAY SYMBOLS

1. Resistor

- Resistance value
 - When no unit is provided: (Ω)
 - K: [k Ω]
 - M: [M Ω]
- Rated permissible power capacity
 - When no display is made: 1/6 [W]
 - Others: Display are provided
- Resistor type
 - No type display: Carbon resistor
 - OMR : Oxidized metal film resistor
 - UNF : Cement resistor
 - MFR : Metal film resistor
 - FR : Fusible resistor

* Composition resistor 1/2 [W] is displayed as "1/2S" or "comp."

2. Capacitor

- Capacity
 - Over 1 [pF] Below 1 [μ F]
- Withstand voltage
 - No display : DC 50 [V]
 - Others : DC withstand voltage [V]
 - AC display : AC withstand voltage [V]
- Display of electrolytic capacitor is as follows.
(Example)
47/50 \rightarrow Capacity [μ F]/withstand voltage [V]
- Capacitor type
 - No type display: Ceramic capacitor
 - MY : Mylar capacitor
 - MM : Metallized Mylar capacitor
 - PP : Polypropylene capacitor
 - MPP : Metallized polypropylene capacitor
 - NP : Nonpolar electrolytic capacitor
 - BP : Bipolar electrolytic capacitor
 - TANTAL : Tantalum capacitor

3. Coil

When no unit is displayed: [μ F]

4. Power supply

 : B1 Voltage

 : B2 Voltage

* Respective voltage values are indicated.

5. Test point & GND symbol

 : Test point of mini-GP pin

 : Only test point display

 : LIVE side ground

 : NEUTRAL side ground

 : EARTH ground

6. Connecting method

 : Connector

 : Wrapping or soldering

 : Receptacle

* Since the reference circuits are provided, the circuits configuration and/or constants are subject to change without prior notice to achieve further improvements.

■ BASINGS OF TRANSISTORS & ICs



2SA844(C)
2SA1015(O,Y)
2SC1815(Y,GR)
2SC1809A(E,F)
2SC1906
2SC1959(Y)
2SC1685
2SC3811(R)
2SA838



2SC1973
2SC1627A
2SC2230
2SC2235
2SC1360



2SC1162(C)
2SC2456
2SD1409



2SD1264A
2SC1409
2SD1263A



2SD637(O,R)



2SC1505
2SD982
2SC2612
2SD866
2SC1905



2SC3336
2SC3310
2SD1433
2SC3449
2SC3461



TA78L012AP



μ PC358C
 μ PC4558C
AN6558

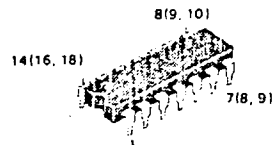

AN5355
TC4528BP
TC4052BP

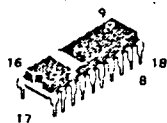

HA11235

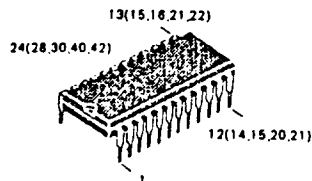

M51491SP
M51493P

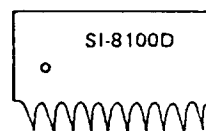

SI-8100D

SI-8100D

■ PARTS LIST (△ Parts in the schematic diagram)

Symbol No.	Parts No.	Parts Name	Symbol No.	Parts No.	Parts Name
MAIN PCB ASS'Y			CRT SOCKET PB ASS'Y		
C1542	QFZ0081-3101S	PP Cap		A75522-C	CRT Socket
C1544	QFZ0081-3801S	MPP Cap			
C1545	QFZ0081-3701S	"			
C1546	QFZ0081-3501S	"			
L1501	CJ39726-A0A	H LIN Coil	OUTSIDE OF PC BOARD ASS'Y		
T1505	CE41043-00E	Side Pin Transf	V01	M34JPS82X	Picture Tube
T1506	CE41052-00A	"	DY01	CJ26903-00A	Def Yoke
D1508	HZ6C1	Zener Diode	T1504	CJ26891-00A	FB Transf
R1918	QRV141F-2702AY	MF R	NF01	CE40811-00E	Noise Filter Unit
R1924	QRV141F-5601AY	"	SW01	QSE4A21-C08	Power SW
R1925	QRD161J-1R0Y	C R	L01	CJ39691-00A	Deg Coil
C1902	QFZ9022-224M	MF Cap	Q1511	2SD1959	Si Transistor
C1904	QCZ9022-104M	"		CEMP004-183K	Power Cord
C1905	QCZ9022-224M	"			
C1906	QCZ9033-103A	C Cap			
C1907	QCZ9033-103A	"			
C1929	QCZ9016-472A	"			
D1901	TVR4N	Si Diode			
D1902	TVR4N	Diode			
D1903	TVR4N	"			
D1904	TVR4N	"			
IC1901	SI-8100D	IC			
T1901	CE40967-00F	SW Transf			
C1935	QCZ9016-102A	C Cap			
F1901	QMF51N2-3ROS	Fuse			
TH1901	A76038	W Posistor			
LF1901	CE41232-00B	Line Filter			
K1907	CE41169-002	Beads Core			
K1906	CE41169-002	"			

MSV-4001A (CONTROL PB ASSY)
 CK30701-B01

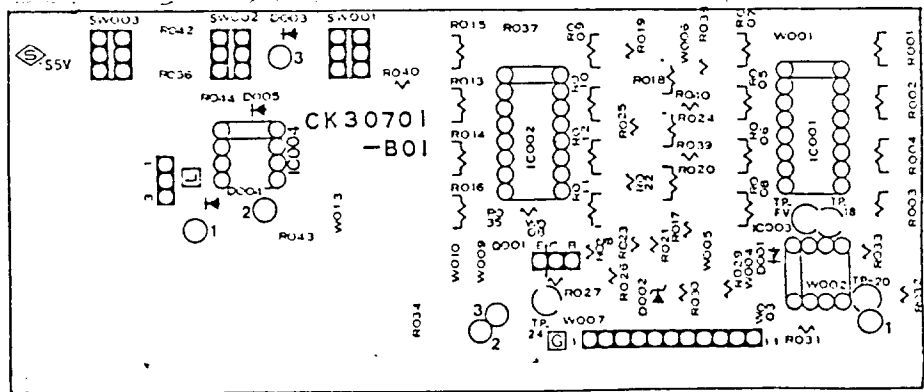
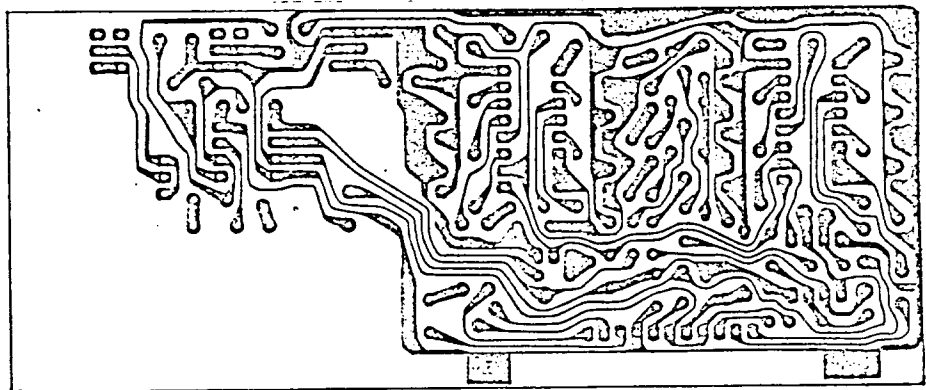
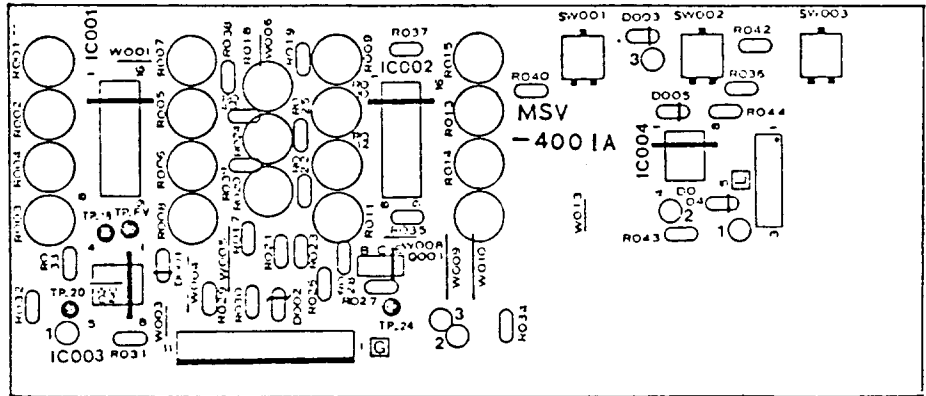

MSV-4102A (FRONT)
CK40295-C01

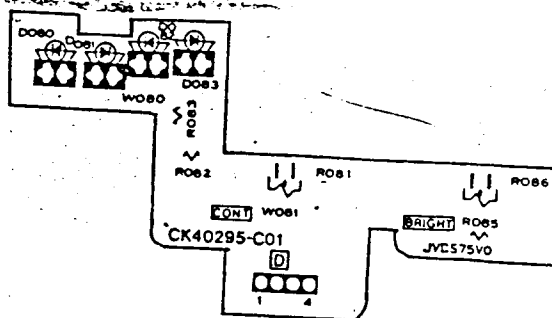
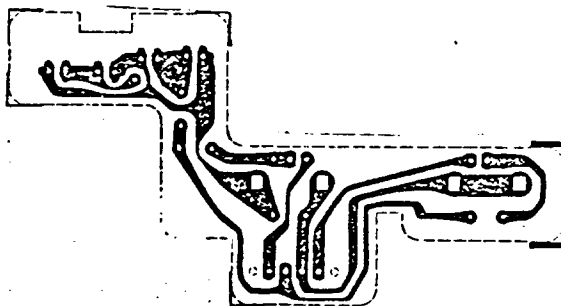
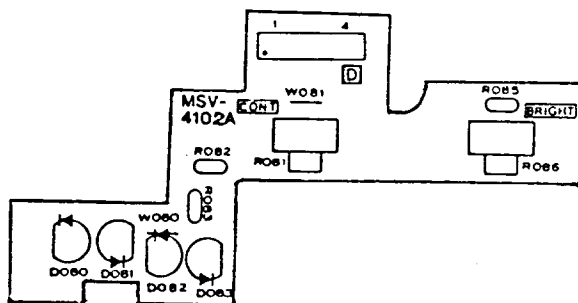

SERVICE INFORMATION

SV-775LR

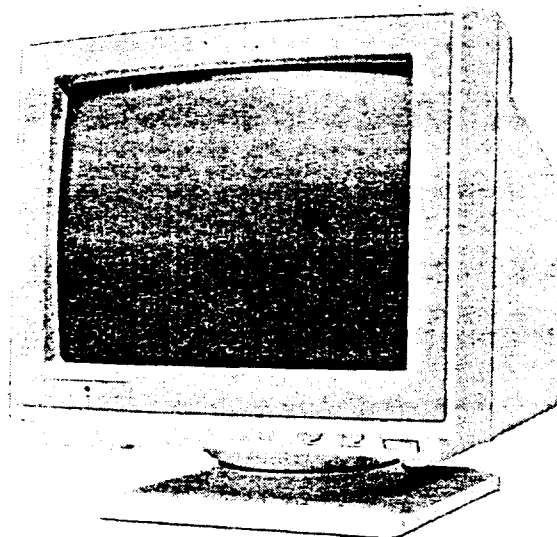

CONTENTS

SAFETY PRECAUTION	2	SERVICE ADJUSTMENT	11 ~ 19
SPECIFICATION	3 ~ 4	ALIGNMENT LOCATIONS	16
FUNCTIONS	5 ~ 7	COLOUR-ADJUSTING MODES	17 ~ 19
BLOCK DIAGRAM	8	REPLACEMENT PARTS LIST	20 ~ 42
HOW TO REMOVE FOR SERVICE	9 ~ 10	EXPLODED VIEW	22 ~ 26
		PACKING DIAGRAM	43
		■ WITH SCHEMATIC DIAGRAM	

SAFETY PRECAUTION

1. The design of this product contains special hardware, many circuits and components specially for safety purposes. For continued protection, no changes should be made to the original design unless authorized in writing by the manufacturer. Replacement parts must be identical to those used in the original circuits. Service should be performed by qualified personnel only.
2. Alterations of the design or circuitry of the products should not be made. Any design alterations or additions will void the manufacturer's warranty and will further relieve the manufacturer of responsibility for personal injury or property damage resulting therefrom.
3. Many electrical and mechanical parts in the products have special safety-related characteristics. These characteristics are often not evident from visual inspection nor can the protection afforded by them necessarily be obtained by using replacement components rated for higher voltage, wattage, etc. Replacement parts which have these special safety characteristics are identified in the parts list of Service manual. Electrical components having such features are identified by shading on the schematics and by (Δ) on the parts list in Service manual. The use of a substitute replacement which does not have the same safety characteristics as the recommended replacement part shown in the parts list of Service manual may create shock, fire, or other hazards.
4. Don't short between the LIVE side ground and NEUTRAL side grounding or EARTH side ground when repairing. Some model's power circuit is partly different in the GND. The difference of the GND is shown by the LIVE (\perp) side GND, the NEUTRAL (∇) side GND and EARTH (\oplus) side GND. Don't short between the LIVE side GND and NEUTRAL side GND or EARTH side GND and never measure with a measuring apparatus (oscilloscope etc.) the LIVE side GND and NEUTRAL side GND or EARTH side GND at the same time.
If above note will not be kept, a fuse or any parts will be broken.
5. If any repair has been made to the chassis, it is recommended that the B₁ setting should be checked or adjusted (See ADJUSTMENT OF B₁ POWER SUPPLY).
6. The high voltage applied to the picture tube must conform with that specified in Service manual. Excessive high voltage can cause an increase in X-Ray emission, arcing and possible component damage, therefore operation under excessive high voltage conditions should be kept to a minimum, or should be prevented. If severe arcing occurs, remove the AC power immediately and determine the cause by visual inspection (incorrect installation, cracked or melted high voltage harness, poor soldering, etc.). To maintain the proper minimum level of soft X-Ray emission, components in the high voltage circuitry including the picture tube must be the exact replacements or alternatives approved by the manufacturer of the complete product.
7. Do not check high voltage by drawing an arc. Use a high voltage meter or a high voltage probe with a VTVM. Discharge the picture tube before attempting meter connection, by connecting a clip lead to the ground frame and connecting the other end of the lead through a 10k Ω 2W resistor to the anode button.
8. When service is required, observe the original lead dress. Extra precaution should be given to assure correct lead dress in the high voltage circuit area. Where a short circuit has occurred, those components that indicate evidence of overheating should be replaced. Always use the manufacturer's replacement components.
9. **Isolation Check**
(Safety for Electrical Shock Hazard)
After re-assembling the product, always perform an isolation check on the exposed metal parts of the cabinet (antenna terminals, video/audio input and output terminals, Control knobs, metal cabinet, screwheads, earphone jack, control shafts, etc.) to be sure the product is safe to operate without danger of electrical shock.

(1) Dielectric Strength Test

The isolation between the AC primary circuit and all metal parts exposed to the user, particularly any exposed metal part having a return path to the chassis should withstand a voltage of 3,000V AC (r.m.s.) for a period of one second. Withstand a voltage of 1,100V AC (r.m.s.) to an appliance rated up to 120V, and 3,000V AC (r.m.s.) to an appliance rated 200V or more, for a period of one second.

This method of test requires a test equipment not generally found in the service trade.

(2) Leakage Current Check

Plug the AC line cord directly into the AC outlet (do not use a line isolation transformer during this check.). Using a "Leakage Current Tester", measure the leakage current from each exposed metal part of the cabinet, particularly any exposed metal part having a return path to the chassis, to a known good earth ground (water pipe, etc.). Any leakage current must not exceed 0.5mA AC (r.m.s.).

• Alternate Check Method

Plug the AC line cord directly into the AC outlet (do not use a line isolation transformer during this check.). Use an AC voltmeter having 1,000 ohms per volt or more sensitivity in the following manner. Connect a 1,500 Ω 10W resistor paralleled by a 0.15 μ F AC-type capacitor between an exposed metal part and a known good earth ground (water pipe, etc.).

Measure the AC voltage across the resistor with the AC voltmeter.

Move the resistor connection to each exposed metal part, particularly any exposed metal part having a return path to the chassis, and measure the AC voltage across the resistor. Now, reverse the plug in the AC outlet and repeat each measurement. Any voltage measured must not exceed 0.35V AC (r.m.s.). This corresponds to 0.5mA AC (r.m.s.).

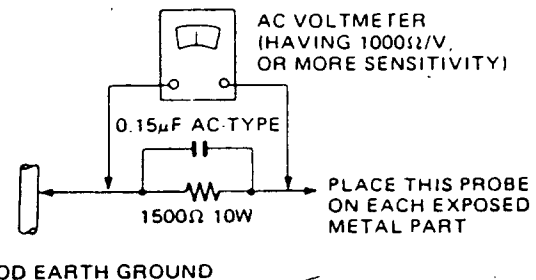

Fig. A

10. High voltage hold down circuit check.

After repair of the high voltage hold down circuit, this circuit shall be checked to operate correctly. See item "How to check the high voltage hold down circuit".

SPECIFICATIONS

Type	: 14-inch colour CRT display
Picture tube	: 13"V, 90° deflection, In-line electron guns. Dot trio phosphor (0.31mm pitch) Short persistence Non-Glare/Tinted
Recommendable display area	: 252(H) x 185(V)mm (CGA, EGA, PGC and TAXAN 555)
Screen size	: 280 x 210mm
Power supply	: AC100 ~ 240V, 50/60Hz
Power consumption	: 1.6 A
Input signal	: TTL/Analog
Input level	: TTL Level(TTL)/0.7Vp-p (Analog)
Connector pin arrangement (9 pin D sub)	:

Signal	TTL				ANALOG	
	f_{H} (kHz)	CGA 15.75	MDA 18.4	EGA 15.75/21.85	TAXAN 555 25.8	PGA 30.48
Pin No.						
1	GND	GND	GND	GND	GND	RED
2	GND	GND	GND/R'	GND	GND	GREEN
3	RED	NC	RED	RED	RED	BLUE
4	GREEN	NC	GREEN	GREEN	GREEN	-H/-V SYNC
5	BLUE	NC	BLUE	BLUE	BLUE	MODE SELECT
6	I	I	I/G'	I	I	R GND
7	NC	VIDEO	NC/B'	NC	NC	G GND
8	+HD	+HD	+HD	-HD	-HD	B GND
9	+VD	-VD	+VD/-VD	-VD	-VD	GND

Input impedance	: 330 Ω (RGB TTL)/75 Ω (RGB Analog)
Input connector	: 9 pin, D-sub connector (TTL/Analog)
Video band width	: 30MHz (-3dB)
Scanning frequency	: (H) 15kHz ~ 34kHz : (V) 50Hz ~ 90Hz
Retrace time	: (H) 6 μ s (max) : (V) 700 μ s (max)
Anode voltage	: 23.0kV \pm 1kV
Dimension	: 356(W) x 349(H) x 398(D)mm
Weight	: 14.7kg

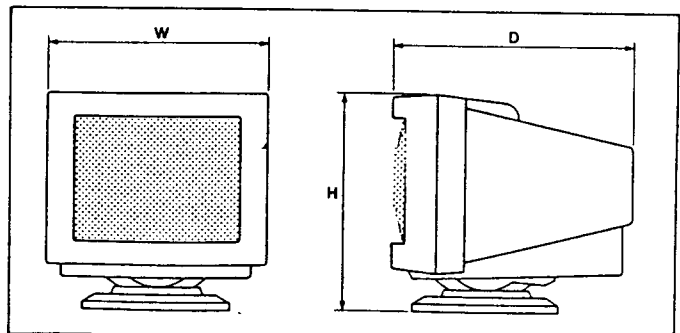

VIDEO TIMING

1) CGA

Format 640 x 200
Pixel Clock (MHz) 14.2

Horizontal

Scan Rate (kHz) 15.75
Blanking (μsec) 11.1
Left Border (μsec) 2.8
Active Display (μsec) 44.8
Right Border (μsec) 5.0
Front Porch (μsec) 1.6
Sync Width (μsec) 3.75
Back Porch (μsec) 5.55
Total (μsec) 63.5

Vertical

Scan Rate (Hz) 59.524
Blanking (msec) 1.02
Top Border (msec) 1.4
Active Display (msec) 12.86
Bottom Border (msec) 1.52
Front Porch (msec) 0.06
Sync Width (msec) 0.19
Back Porch (msec) 0.77
Total (msec) 16.8

2) TAXAN 555

Format 800 x 400
Pixel Clock (MHz) 27.43546

Horizontal

Scan Rate (kHz) 25.85812
Blanking (μsec) 9.513
Left Border (μsec) none
Active Display (μsec) 29.159
Right Border (μsec) none
Front Porch (μsec) 2.515
Sync Width (μsec) 1.822
Back Porch (μsec) 5.176
Total (μsec) 38.67

Vertical

Scan Rate (Hz) 56.7064
Blanking (msec) 1.02 2.166
Top Border (msec) none
Active Display (msec) 15.468
Bottom Border (msec) none
Front Porch (msec) 0.06 0.619
Sync Width (msec) 0.19 0.619
Back Porch (msec) 0.77 0.928
Total (msec) 17.634

3) EGA

Format 640 x 350
Pixel Clock (MHz) 16.2

Horizontal

Scan Rate (kHz) 21.85
Blanking (μsec) 6.4
Left Border (μsec) none
Active Display (μsec) 39.4
Right Border (μsec) none
Front Porch (μsec) 0
Sync Width (μsec) 4.8
Back Porch (μsec) 1.6
Total (μsec) 45.8

Vertical

Scan Rate (Hz) 59.88
Blanking (msec) 0.83
Top Border (msec) none
Active Display (msec) 15.87
Bottom Border (msec) none
Front Porch (msec) 0.14
Sync Width (msec) 0.6
Back Porch (msec) 0.09
Total (msec) 16.7

4) PGA

Format 640 x 400 640 x 480
Pixel Clock (MHz) 25 25

Horizontal

Scan Rate (kHz) 30.5 30.5
Blanking (μsec) 7.15 7.15
Left Border (μsec) none none
Active Display (μsec) 25.6 25.6
Right Border (μsec) none none
Front Porch (μsec) 0 0
Sync Width (μsec) 4.5 4.5
Back Porch (μsec) 2.65 2.65
Total (μsec) 32.75 32.75

Vertical

Scan Rate (Hz) 59.52
Blanking (μsec) 7.15 3.6 1
Top Border (msec) none none
Active Display (msec) 13.2 15.8
Bottom Border (msec) none none
Front Porch (msec) 1.5 0.2
Sync Width (msec) 0.066 0.066
Back Porch (msec) 2.034 0.734
Total (msec) 16.8 16.8

FUNCTIONS

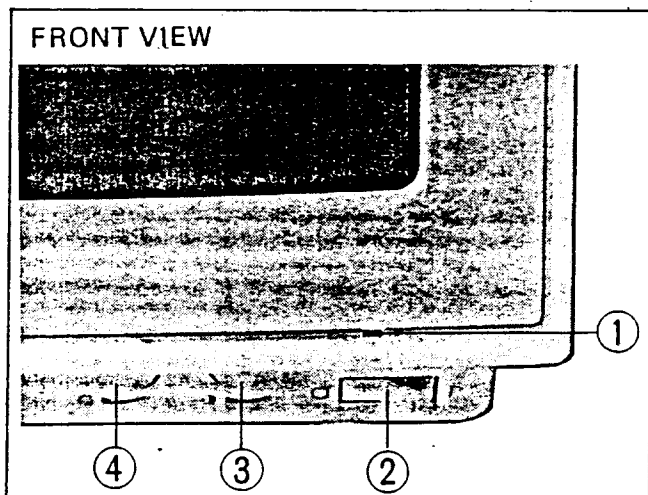

- ① POWER indicator
Lights when the power is turned on.
- ② POWER switch
Press "I" side to turn the power on. The POWER indicator lights. Press the "O" side to turn the power off.
- ③ CONTRAST control
Turn to adjust the contrast of the picture to your preference.
- ④ BRIGHT control
Turn to adjust the picture brightness to your preference.

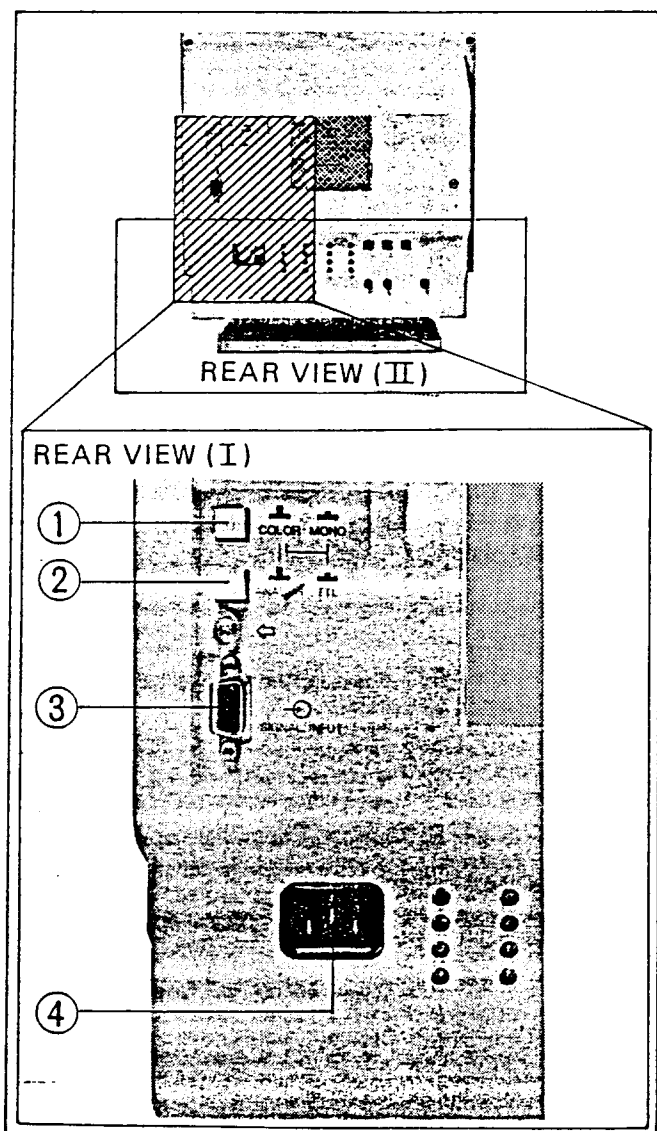

- ① COLOUR/MONO switch
Use only when TTL signals are input. Press to switch the picture mode depending on the signals input.
COLOUR: Set to this position when TTL colour signals are input.
(When connected to the TAXAN 555, CGA or EGA, etc.)
MONO: Set to this position when TTL monochrome signals are input.
(When connected to the MDA, etc.)
- ② ANALOG/TTL switch
ANALOG: Set to this position when connected to equipment which outputs RGB analog signals (such as the PGA).
TTL: Set to this position when connected to equipment which outputs RGB TTL signals (such as the TAXAN 555, MDA, CGA or EGA).
- ③ SIGNAL INPUT connector
Connect to the RGB output (either TTL or Analog) of the computer. Use the signal cable provided for connection.
- ④ POWER INPUT connector
Connect the provided power cord between this and an AC outlet.

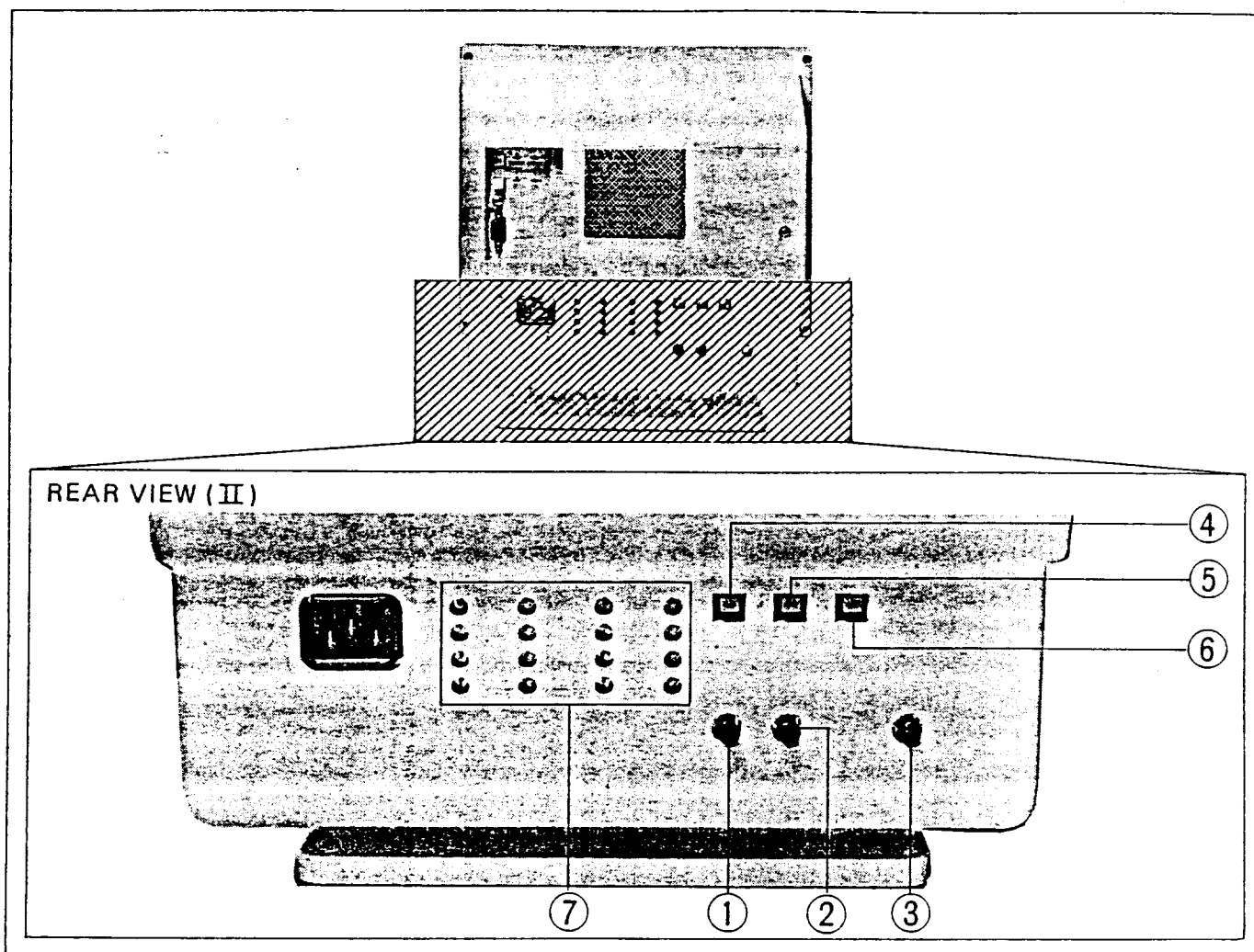

- ① **V SIZE control**
Turn to adjust the vertical size of the picture. Center click is the standard setting.
- ② **V POSI control**
Turn to adjust the vertical position of the picture. Center click is the standard setting.
- ③ **H POSI control**
Turn to adjust the horizontal position of the picture. Center click is the standard setting.
- ④ **PRESET switch**
AUTO: Set to this position when connected to an IBM, IBM-compatible computer or TAXAN 555. The monitor automatically selects the setting of the appropriate PRESET CONTROL screw group (A, B, C or D) depending on the computer connected.
RELEASE: Set to this position when connected to a computer other than the above.
- ⑤ **SCAN SIZE switch**
Press to switch the size of the picture on the screen.
AUTO: Set to this position when connected to an IBM, IBM-compatible computer or TAXAN 555. The picture size is determined automatically.
OVER SCAN: Set to this position when connected to a computer other than the above and the picture is too small.
- ⑥ **COLOUR MODE switch**
Use only when the TTL signals are input and when the COLOUR/MONO switch is set to "COLOUR". Press to switch the colour mode according to the computer connected.
AUTO: Set to this position when connected to an IBM or IBM-compatible computer.
16 COLOURS: Set to this position when connected to a computer other than above and 16 colours cannot be correctly displayed if it is in the 16-colour display mode (TAXAN 555).

- ⑦ PRESET CONTROL screws
These function as sub controls to vary the adjustment range of the center clicks of picture controls ①, ② and ③.

Ⓛ : VERTICAL SIZE control

Ⓞ : VERTICAL POSITION control

Ⓜ : HORIZONTAL SIZE control*

Ⓞ : HORIZONTAL POSITION control
(* Horizontal size control screw functions as the main control.)

Turn the appropriate group of screws (A, B, C or D) depending on the setting of the PRESET switch (depending on the computer connected), with controls ①, ② and ③ restored to their center click positions. Use a screwdriver to turn them.

- 1) When the PRESET switch is set to "AUTO" (when connected to an IBM, IBM-compatible computer or TAXAN 555. Turn A, B, C or D screws according to the chart below.

Screw groups	Adapter (board) used
A	PGA* ($f_{H}^{**}=30.48\text{kHz}$)
B	TAXAN 555 ($f_{H}=25.85\text{kHz}$)
C	CGA* or EGA* ($f_{H}=15.75\text{kHz}$)
D	EGA* ($f_{H}=21.85\text{kHz}$)

*PGA=Professional Graphics Adapter
EGA=Enhanced Graphics Adapter
CGA=Colour Graphics Adapter
** f_{H} =Horizontal scanning frequency

- Note: When using the MDA, adjust group A's PRESET CONTROL screws. In this case, the EGA presetting will be cancelled.
- 2) When the PRESET switch is set to "RELEASE" (when connected to a computer other than the above). Turn only "A" screws. (Other groups of screws have no effect.)

HOW TO REMOVE FOR SERVICE

REMOVING THE REAR COVER

1. Unplug the power supply cord.
2. Unscrew the six screws marked (A) shown in Fig. 1.
4. Withdraw the REAR COVER backward.

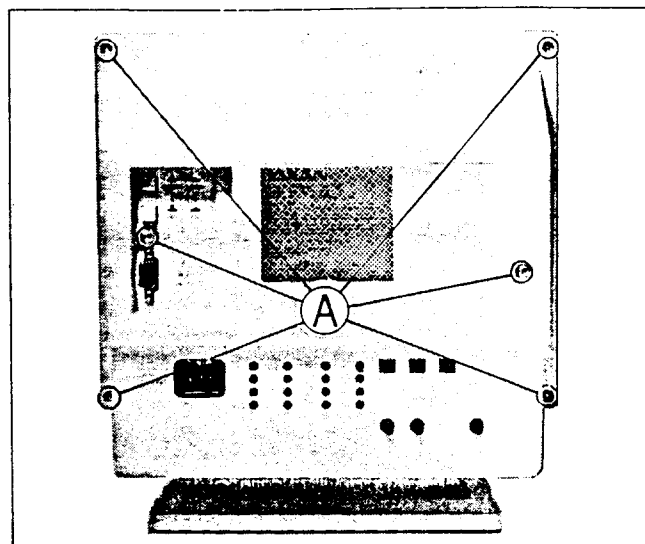

Fig. 1

REMOVING THE PEDESTAL ASS'Y

1. Pull the Lock Knob of PEDESTAL ASS'Y marked (B) shown in Fig. 2, and remove the PEDESTAL ASS'Y.
- * When the PEDESTAL ASS'Y has been removed, the metal fittings marked (C) can be removed.

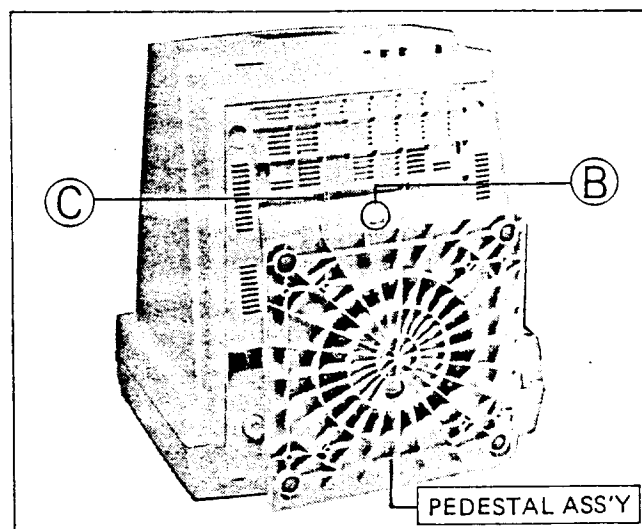

Fig. 2

REMOVING THE CHASSIS

- * After removing the rear cover and the pedestal ass'y.
1. Unscrew the thirteen screws marked (D) shown in Fig. 3 and 4, and remove the rear shield.
 2. Remove the eight screws marked (E) shown in Fig. 3.
 3. Remove the two screws marked (F) shown in Fig. 4, and remove the left shield.

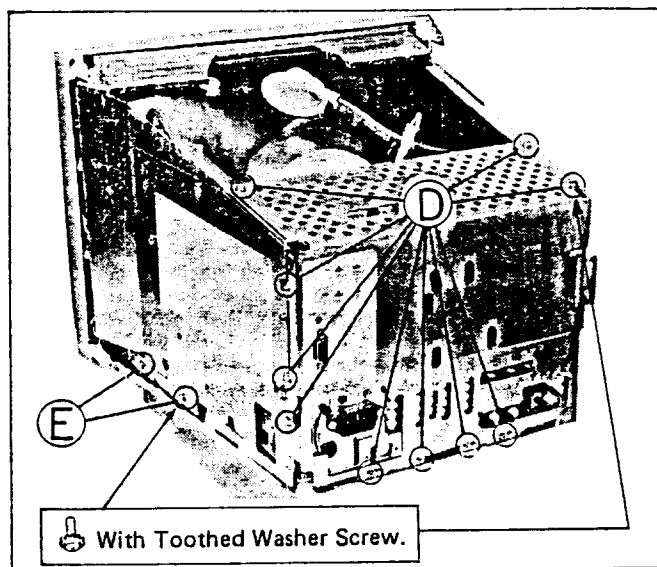

Fig. 3

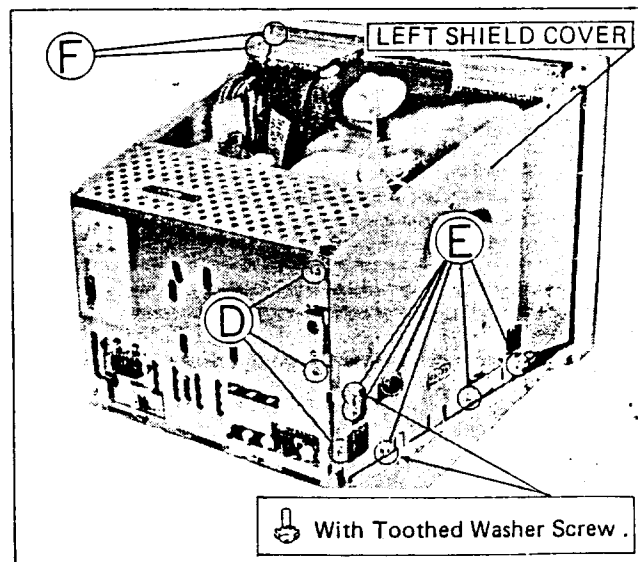

Fig. 4

4. Unscrew the screw marked (G) shown in Fig. 5, and loosen the screw marked (H).
 5. Remove the CRT socket PB after loosening the screw marked (I) shown in Fig. 6. Then remove the connectors, and wire clamps (if necessary).
 6. Then pull out the chassis from the installed position.
- * When conducting a check with power supplied, be sure to confirm that the CRT earth wire is connected to the CRT socket board and the PC Board chassis.

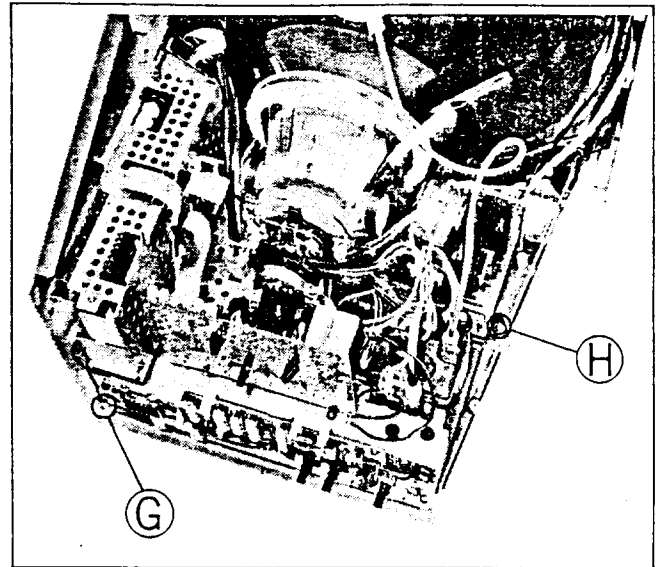

Fig. 5

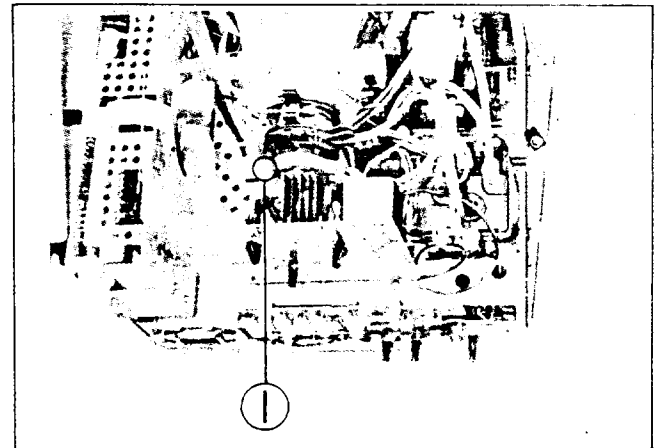

Fig. 6

■ WIRE CLAMPING AND TYING BAND

1. Be sure to clamp the wire.
2. Never remove the tying band used for clamping. Should it be inadvertently removed, be sure to clamp the wire again, using insulating material.

SERVICE ADJUSTMENTS

* For items of which the locations of the adjustment parts are not described, refer to the "ALIGNMENT LOCATIONS".

PREPARATION BEFORE MAKING ADJUSTMENT

INSTRUMENTS

Measuring instruments and jigs required for adjustment.

- ° RGB signal generator (make use of TTL Level and Analog)
- ° Oscilloscope
- ° Voltmeter (Digital Voltmeter, Tester, etc.)
- ° Knob screwdriver
- ° Hexagon core wrench
- ° Scale

WARMING-UP

Turn the power on the unit to be adjusted and the measuring instruments at least 30 minutes beforehand for warming-up.

CONFIRM

Before adjusting each section, confirm that the following rough adjustments have been completed.

- (1) Confirm that the white balance has been adjusted. If it is out of order, adjust it by following the description in "White Balance Adjustment".
- (2) Confirm the horizontal synchronization is normal. If it is out of order, adjust it by following the descriptions in "H HOLD Adjustment".
- (3) Display @ and confirm that the picture is in focus.

GENERAL ADJUSTMENT

ADJUSTMENT OF B₁ VOLTAGE

- (1) Confirm that the AC input voltage is 230V.
- (2) No video apply. ($f_H=21.85\text{kHz}$)
- (3) Adjust the voltage of TP-HB (located on the CRT socket PB) to $126V \pm 1V$ by using the B₁ ADJ VR (R1920).
- (4) Confirm that no change have been on Screen if power supply voltage changes $90V \sim 264V$.

ADJUSTMENT OF H HOLD

- (1) Display cross-hatch or white field pattern. ($f_H=21.85\text{kHz}$, $f_V=60\text{Hz}$)
- (2) Initiate free running status by connecting the TP-B and TP-E.
- (3) Adjust the H FREQ VR (R1521) until the pattern is almost stable.
- (4) Check to see if horizontal synchronization is fully established even if the cabling in (2) is disconnected and f_H is changed to 15.75kHz (CGA), 21.85kHz (EGA) or 30.5kHz (PGA).

* Note

If the monitor is not synchronized by 15.75kHz or 30.5kHz improper adjustment or trouble in the MA-A001A-W modules may be cause.

ADJUSTMENT OF HIGH VOLTAGE

* Confirm that the H HOLD (FREQ) has been adjusted and that the H HOLD and V HOLD have not been turned on.

- (1) Be sure and connect the earth of high voltage meter with chassis frame.
- (2) Connect the probe of high voltage meter with the anode of CRT.
- (3) No video apply. $f_H=21.85\text{kHz}$. (If raster is shown then adjust the BRIGHT VR or SCREEN VR until no raster.)
- (4) Adjust the HV ADJ VR (R1539) until the high voltage is between $23.0\text{kV} \pm 0.1\text{kV}$.
- (5) Check to see the High Voltage is from $23.0\text{kV} \pm 1\text{kV}$. When f_H is changed to 15.75kHz (CGA) and 30.5kHz (PGA).

FOCUSING ADJUSTMENT

* Confirm that the HV and WHITE BALANCE have been adjusted.

- (1) Display the @ mark over the entire screen (against the background).
- (2) The CONTRAST VR should be turned to the position where @ mark is just before saturated.
- (3) Adjust the FOCUS VR until the center and peripheral areas are uniformly in focus.

HOW TO CHECK THE HIGH VOLTAGE HOLD DOWN CIRCUIT

* Confirm that the High Voltage has been adjusted and that the H HOLD and V HOLD have not been turned on.

- (1) Be sure and connect the earth of high voltage meter with chassis frame.
- (2) Connect the probe of high voltage meter with the anode of CRT.
- (3) No video apply. (If raster is shown then adjust the BRIGHT VR(R4086) or SCREEN VR until no raster.)
- (4) Check to see the High Voltage is from 22.0kV to 24.0kV.
- (5) Connect the resistor (10k Ω) and potentiometer (100k Ω) at TP-A & Earth (TP-E).
- (6) Rotate the potentiometer so the resistance decrease.
- (7) Confirm the picture goes out before high voltage reaches 26.5kV. (As the picture goes out, high voltage will not be applied any more.)

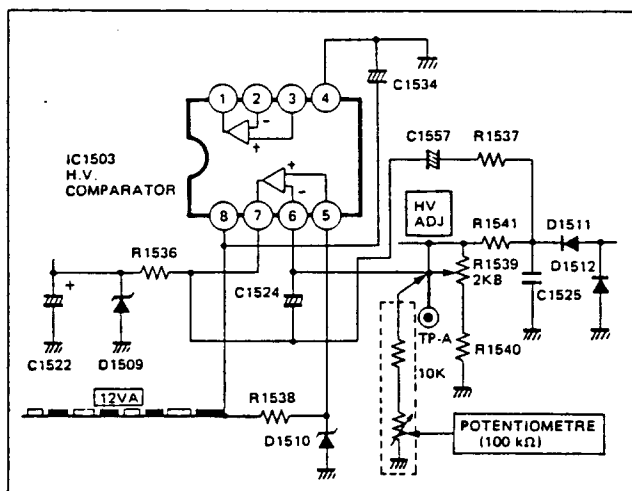

ADJUSTMENT OF SIZE/POSI VR SELECT

- (1) Set all the rear control knob of V SIZE(R1407), V POSI(R1409) and H POSI(R1511) to the click position.
- (2) Turn the R4018, R4020 and R4024 fully clockwise.
- (3) Set the both of PRESET CANCEL SW and OVER SCAN SW to the OFF(AUTO) position.
- (4) After inputting the signal of $f_{H}=23.5\text{kHz}$, read the value on the digital voltmeter, and adjust the R4018 so that the voltage of TP-18 becomes the same value of the TP-Fv.
- (5) After inputting the signal of $f_{H}=28.5\text{kHz}$, read the value on the digital voltmeter, and adjust the R4024 so that the voltage of TP-24 becomes the same value of the TP-Fv.

- (6) Then, after inputting the signal of $f_{H}=17.175\text{kHz}$, read the value on the digital voltmeter, and adjust the R4020 so that the voltage of TP-20 becomes the same value of the TP-Fv.
- (7) Confirm that each VR is changed by each signal CGA(15.75kHz), EGA(21.85 kHz), TAXAN 555(25.85kHz) or PGA(30.5 kHz).

REAR CONTROL P.C.B

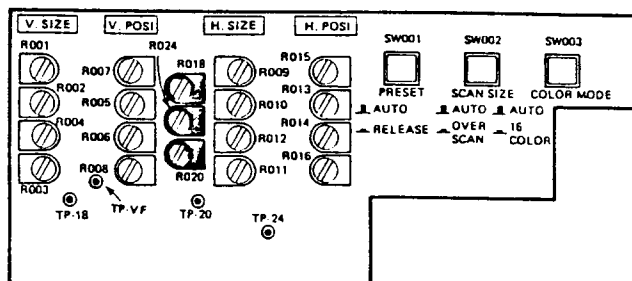

CONFIRMATION OF THE ACTIONS OF PRESET SW AND SCAN SIZE SW.

- (1) Confirmation of PRESET SW
Confirm that when PRESET SW is positioned at RELEASE(ON) is any of CGA (15.75kHz), TAXAN 555(25.85kHz), EGA (21.85kHz), or PGA(30.5kHz) is input. the variable motion of H POSI, H SIZE, V SIZE and V POSI can be operated by PRESET VR of "A".
* Don't rotate the R4018, R4020 and R4024.
- (2) Confirmation of SCAN SIZE SW
Confirm that when TAXAN 555(25.85 kHz), EGA and PGA are inputted, if SW is positioned at OVER SCAN(ON) the picture is in the condition of over scan.
* CGA's standrd position is at OVER SCAN.

The picture size remains unchanged if the SCAN SIZE SW is positioned at AUTO or OVER SCAN.

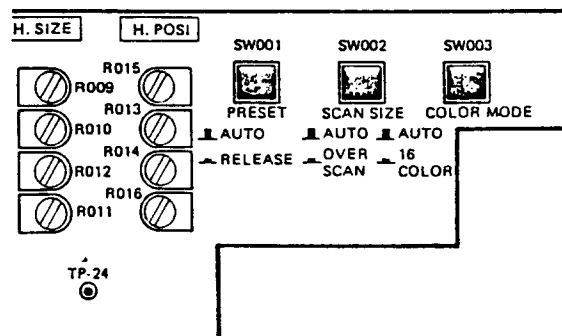

ADJUSTMENT OF VERTICAL HEIGHT

* Confirm that the H HOLD(FREQ) and HV have been adjusted.

- (1) Display cross-hatch pattern ($f_{II}=15.75\text{kHz}$, $f_V=60\text{Hz}$, over scan mode).
- (2) Set the V SIZE VR(R1407 and R4004) to the maximum position.
- (3) If SIZE, POSI VR SELECT have not been adjusted, turn the SCAN SIZE SW on OVER SCAN MODE.
- (4) By rotating the V HEIGHT VR(R1428), adjust the voltage so that the voltage of TP-V becomes $5.2V \pm 0.2V$.
- (5) After the above adjustment, ensure that the height can be varied by rotating the V SIZE VR.

ADJUSTMENT OF VERTICAL LINEARITY

* Confirm that the H HOLD and HV have been adjusted.

- (1) Display cross-hatch pattern. ($f_V=60\text{Hz}$, $f_{II}=21.85\text{kHz}$)
- (2) Set the height to its maximum by the V SIZE VR(R1407 & R4003).
- (3) Adjust the upper and lower linearity to an optimum by the V LIN VR(R1430).
- (4) After the above adjustment, ensure that the height can be varied by rotating the V SIZE VR(R1407).
- (5) Change the input frequency f_V to 50Hz, 90Hz and check to see if the linearity at this frequency is the same as in $f_V=60\text{Hz}$. Adjust the V LIN VR(R1430) again if the above is not true.
- (6) Check to see if the V SIZE VR as in an input frequency f_V of 90Hz when 50Hz is selected.

ADJUSTMENT OF H CENTER AND V CENTER

* Confirm that the V HEIGHT and V LIN have been adjusted.

- (1) No video apply. ($f_{II}=21.85\text{kHz}$, $f_V=60\text{Hz}$) SCAN SIZE SW set to AUTO(OFF).
- (2) Adjust the BRIGHT VR until the raster on the screen is just barely visible.
 - * If the raster runs out of the screen, adjust the H SIZE VR(A) and V SIZE VR(A) of the PRESET until the picture is placed proper position.
- (3) Adjust the V CENTER VR(R1471) until the raster is vertically centered in the screen.
- (4) Adjust the H CENTER SW(S1501,S1502) until the raster is horizontally centered in the screen. In case of can't H Center adjustment, change the position of H CENTER SW(S1503). Then readjust again.
 - * Be sure and turn on S1501 and S1502 at the same time.

ADJUSTMENT OF H SIZE, H POSI, V SIZE AND V POSI (at PGA) [I]

* Confirm that the H HOLD, HV, V HEIGHT, V LIN, H CENT, V CENT, SIZE and the POSI VR SELECT have been adjusted.

- (1) Set the CONTRAST VR to max. and BRIGHT VR to the central position.
- (2) Display cross-hatch negative pattern. ($f_{II}=30.5\text{kHz}$)
- (3) Adjust the H SIZE VR(A: R4009) until the horizontal width becomes $252 \pm 4\text{mm}$.
- (4) Adjust the H POSI VR(A: R4015) until the pattern becomes horizontally centered in the screen.
- (5) Adjust the V SIZE VR(A: R4001) until the vertical height becomes $185 \pm 4\text{mm}$.
- (6) Adjust the V POSI VR(A: R4007) until the pattern becomes vertically centered in the screen.

REAR CONTROL P.C.B

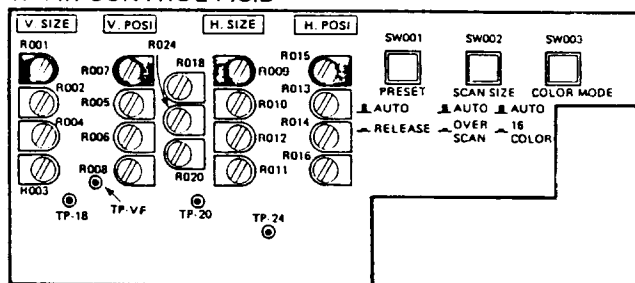

ADJUSTMENT OF H SIZE, H POSI, V SIZE AND V POSI (at TAXAN 555) [II]

* Confirm that the H HOLD, HV, V HEIGHT, V LIN, H CENT, V CENT, SIZE and the POSI VR SELECT have been adjusted.

- (1) Set the CONTRAST VR to max. and BRIGHT VR to the center position.
- (2) Display cross-hatch negative pattern. ($f_{II}=25.85\text{kHz}$)
- (3) Adjust the H SIZE VR(B: R4010) until the horizontal width becomes $252 \pm 4\text{mm}$.
- (4) Adjust the H POSI VR(B: R4013) until the pattern becomes horizontally centered in the screen.
- (5) Adjust the V SIZE VR(B: R4002) until the vertical height becomes $185 \pm 4\text{mm}$.
- (6) Adjust the V POSI VR(B: R4005) until the pattern becomes vertically centered in the screen.

REAR CONTROL P.C.B

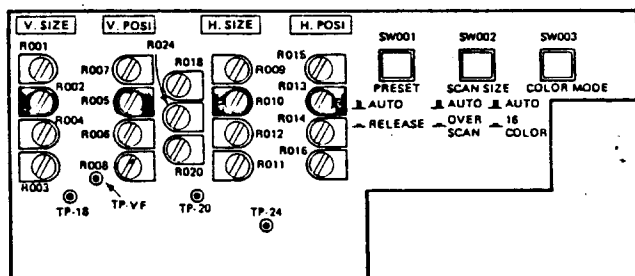

ADJUSTMENT OF H SIZE, H POSI, V SIZE AND V POSI (at CGA) [III]

* Confirm that the H HOLD, HV, V HEIGHT, V LIN, H CENT, V CENT, SIZE and the POSI VR SELECT have been adjusted.

- (1) Set the CONTRAST VR to max. and BRIGHT VR to the central position.
- (2) Display cross-hatch negative pattern. ($f_{H}=15.75\text{kHz}$)
- (3) Adjust the H SIZE VR(C: R4012) until the horizontal width becomes $252\pm 4\text{mm}$.
- (4) Adjust the H POSI VR(C: R4014) until the pattern becomes horizontally centered in the screen.
- (5) Adjust the V SIZE VR(C: R4004) until the vertical height becomes $185\pm 4\text{mm}$.
- (6) Adjust the V POSI VR(C: R4006) until the pattern becomes vertically centered in the screen.

REAR CONTROL P.C.B

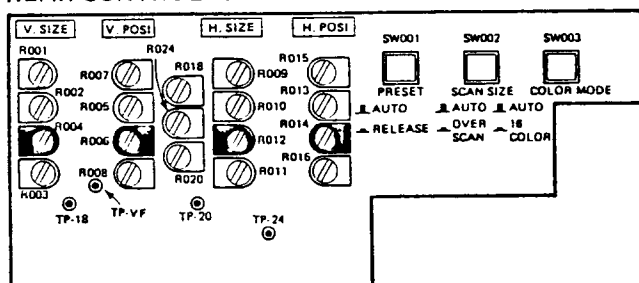

ADJUSTMENT OF H SIZE, H POSI, V SIZE AND V POSI (at EGA) [IV]

* Confirm that the H HOLD, HV, V HEIGHT, V LIN, H CENT, V CENT, SIZE and the POSI VR SELECT have been adjusted.

- (1) Set the CONTRAST VR to max. and BRIGHT VR to the central position.
- (2) Display cross-hatch negative pattern. ($f_{H}=21.85\text{kHz}$)
- (3) Adjust the H SIZE VR(D: R4011) until the horizontal width becomes $252\pm 4\text{mm}$.
- (4) Adjust the H POSI VR(D: R4016) until the pattern becomes horizontally centered in the screen.
- (5) Adjust the V SIZE VR(D: R4003) until the vertical height becomes $185\pm 4\text{mm}$.
- (6) Adjust the V POSI VR(D: R4008) until the pattern becomes vertically centered in the screen.

REAR CONTROL P.C.B

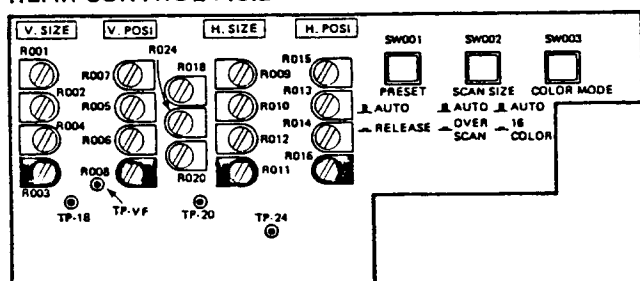

ADJUSTMENT OF SIDE PIN CUSHION

* Confirm that the V HEIGHT, V LIN, and the UNDER SCAN V HEIGHT have been adjusted.

- (1) Display cross-hatch pattern. ($f_{H}=21.85\text{kHz}$, $f_{V}=60\text{Hz}$)
- (2) Adjust the SPCC VR(R1446) until the side pin cushion to its optimum.
- (3) Confirm that the side pin cushion is proper by changing f_{V} to 50Hz and 90Hz. Perform the procedure describe in (3) above if the side pin cushion in malfunctioning at 50Hz or 90Hz.
- (4) Confirm that the side pin cushion at cross-hatch pattern of $f_{V}=15.75\text{kHz}$.

White Balance Adjustment

CUT-OFF VR Adjustment

- (1) No video apply.
- (2) Turn the CUT OFF VRs(R3104, R3204, R3304) and the SCREEN VR fully counterclockwise.
- (3) Set the SERVICE SW(SW1401) to the "S" position.
- (4) Set the BRIGHTNESS VR to the center position (click).
- (5) Connect the oscilloscope to TP-47R, adjust the subbright VR(R1007) until no pulse is generated.
- (6) Connect the oscilloscope to TP-47R, TP-47G and TP-47B and adjust the CUT OFF VR(R3104, R3204, R3304) so that each output becomes 110V.
- (7) Turn the SCREEN VR clockwise to a position where a single line is faintly displayed.
- (8) Not using the CUT OFF VR which produced a colour first, but using the other two CUT OFF VRs, adjust the colours so that the three colorus emit a little light at the same level.
- (9) Set the SERVICE SW to the "N" position.

DRIVE VR Adjustment

- (10) Set the CONTRAST VR(R4081) to its maximum position.
- (11) Display window pattern. (Input the analog signal with which the beam limiter is not applied.)
- (12) Connect the oscilloscope to TP-47R: and adjust the RED DRIVE VR(R3102) so that the drive voltage from the black to white levels becomes $40\text{Vp-p} \pm 2\text{Vp-p}$.

- (13) Adjust DRIVE VRs for G and B (excluding that for R) until the raster becomes white.
- * By using the DRIVE VRs for G and B, adjust the colours to obtain $8500^{\circ}\text{K}+30\text{MPCD}$ of the specified colour temperature.
(Satisfy the following values by means of the respective measuring instruments.)
TOPCON Luminance Meter:
 $X=0.283\pm 0.01$, $Y=0.320\pm 0.01$.
MINOLTA Colour Analyzer Type TV-2140:
 $X=0.302$, $Y=0.316$.)
- Note: Prior to adjustment, carefully confirm the input signal level (that R, G, B signals are at the same level).
- (14) Input the TTL signal. (Confirm that the I-signal is input.)
- (15) TTL/ANALOG switch(SW6001) to TTL side.
- (16) Display window pattern. (Signal with which the beam limiter is not applied.)
- (17) Adjust the TTL R LEVEL VR(R6109) and TTL B LEVEL VR(R6309) until the raster becomes white.
- (18) Confirm that the white balance is the designated colour temperature.

■ CONFIRMATION OF ACTION OF SYNCHRONIZING SIGNALS

- (1) Confirm of TTL input position
H SYNC is connected to pin ⑧ of the 9 pin connector and V SYNC is connected to pin ⑨ of the same connector. Confirm that irrespective of the polarity of each synchronizing signal, positive or negative, the monitor is correctly synchronized with respect to (HS) 15.75kHz, 21.85kHz and (VS) 50Hz, 60Hz, 90Hz.
- (2) Confirm of ANALOG input position.
Input the composite synchronizing signal of HS and VS to pin ④ of the 9 pin connector and confirm that the monitor is correctly synchronized with respect to (HS) 30.5kHz of negative polarity.

■ CONFIRM OF INPUT OF TTL SIGNALS

- (1) Confirm of display of 16 colours
1) Confirm that COLOUR MODE SW is at the AUTO(OFF) position.
2) Input R, G, B, I and +VD and confirm that 16 colours can be displayed by a combination of these signals.
- (2) Confirm of display of 64 colours
1) Confirm that COLOUR MODE SW is at the AUTO(OFF) position.
2) Input R, G, B, R', G', B' and -VD and confirm that 64 colours can be displayed by a combination of these signals.
- (3) Confirm that when COLOUR MODE SW is made to 16 COLOURS(ON) position with the same signals as in item (2) the display is changed from 64 colours display to 16 colours display.

Note: Confirmation of 8 colours display is done concurrently with that of 16 colours display. In the case of 8 colours display, I signal is not included, so that the brightness is 60 to 70% of that of 16 colours display.

ADJUSTMENT OF MODULE

■ ADJUSTMENT OF MA-A001A MODULE (CM1801)

- (1) Input the signal of $f_H=15.75\text{kHz}$.
- (2) Adjust the pulse width of the output waveform of pin ⑱ to $40\pm 1\mu\text{sec}$ by adjusting VR(R25) in the module.

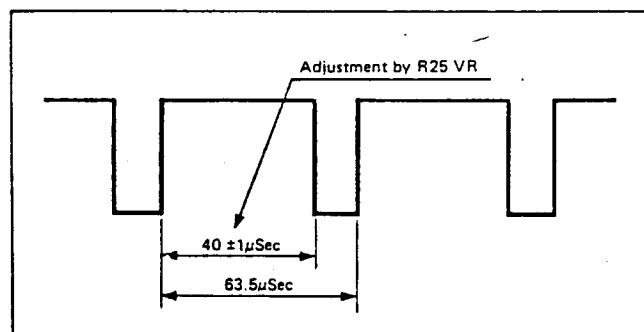

Output Wave Form of Pin ⑱

ALIGNMENT LOCATIONS

MAIN P.C.BOARD

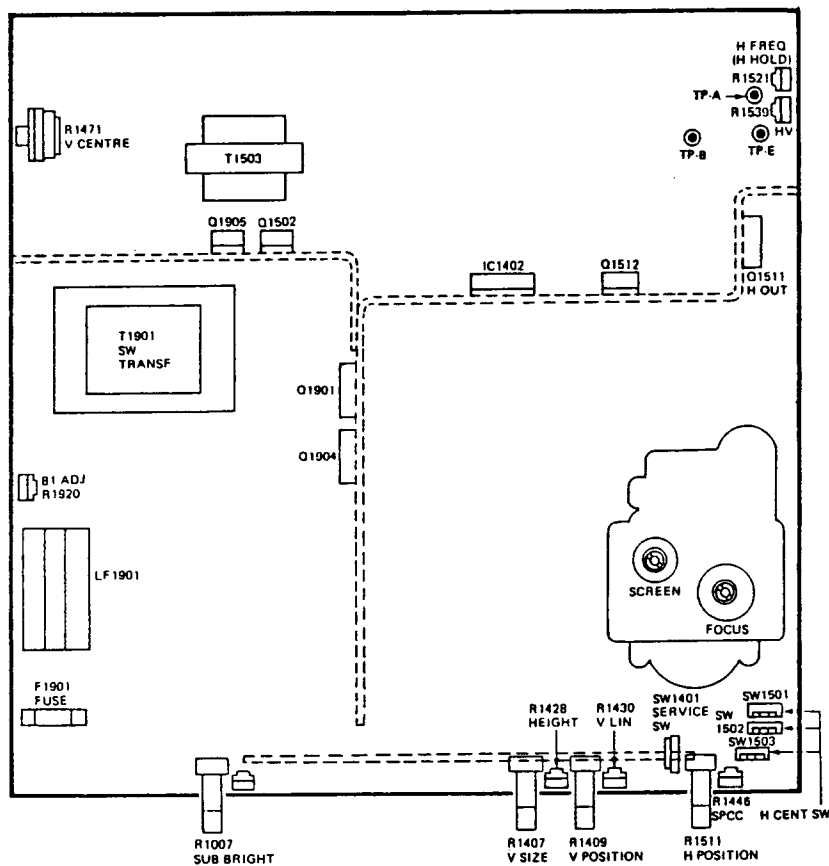

INPUT P.C.BOARD

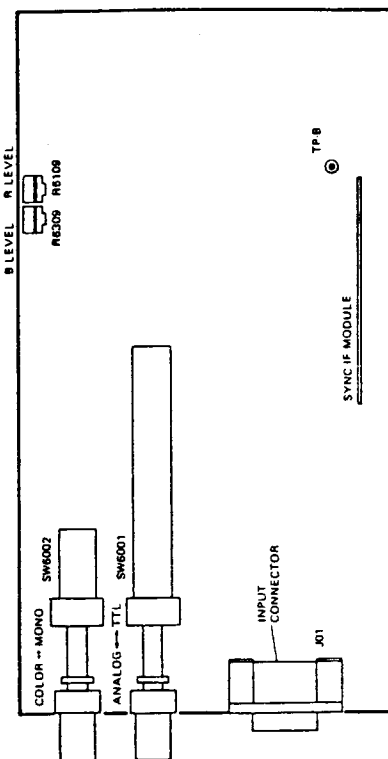

REAR CONTROL P.C.BOARD

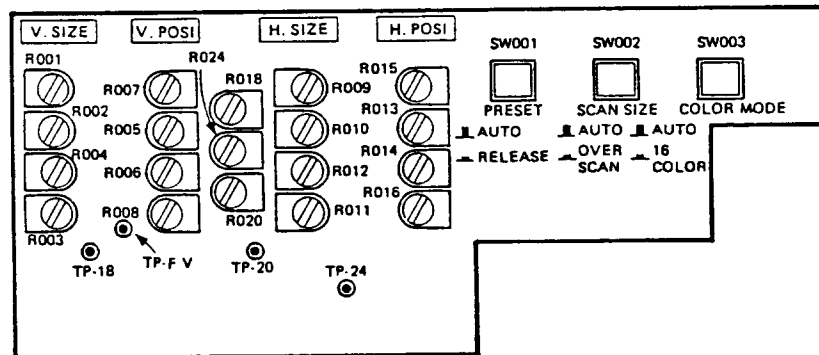

CRT SOCKET P.C.BOARD

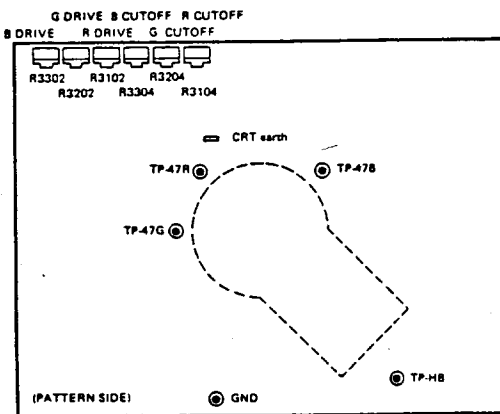

COLOUR ADJUSTING MODES

- Make an adjustment when replacing a cathode-ray tube or when colour shading occurs. Basically, adjustment can be made in the same manner as for television, but concerning display characteristics, it requires a greater degree of accuracy than television. Moreover, functions such as convergence take place in a quite delicate manner because a high-fineness CRT or medium-fineness CRT are used as the cathode-ray tube. Therefore, extreme care should be exercised when carrying out the adjustment.

■ CRT REPLACEMENT AND PREPARATIONS TO BE CONDUCTED BEFORE COMMENCING ADJUSTMENT

1. Wipe the entire CRT body lightly with a cloth.
2. Wind adhesive tape around two places on the neck part of the CRT. (Fig. 1)

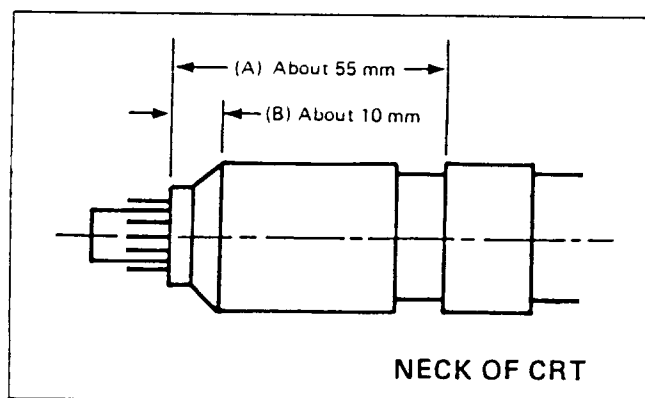

Fig. 1

3. Insert a deflecting yoke into the neck of the CRT without removing the tape.
4. Fasten a clamp screw so that the deflecting yoke is easily turned.
5. Attach a PC magnet and fasten a clamp screw.
6. As it is affected by the earth's magnetism, point the front of the CRT tube to the east or west (when a setting place is known beforehand, set it accordingly).
7. After attaching and wiring the deflecting yoke, CRT, socket, anode and earth, turn the switch "on" and confirm that a picture appears. Then make sure to demagnetize the entire CRT with a degaussing Coil.

■ PURITY ADJUSTMENT

Before starting the adjustment

1. Demagnetize with a degaussing coil.
2. Remove the adhesive which is fixing the 6 magnet plates using a screwdriver, and loosen the magnet lock so that the magnet plates can be turned.

Adjusting Modes

1. Turn a green cutoff VR and a red/blue cutoff VR to the extreme right and left, respectively. Under this condition, the raster is easier to see when adjusting a screen VR.
2. Loosen the clamp screw fastening the deflecting yoke and draw the deflecting yoke to the extreme rear to produce round-shaped colour shading (when phosphors of the RGB is coated in stripes, it appears as vertical stripes).
3. Overlap the long and short tabs of the two purity magnets alternately and temporarily set them in a horizontal position.
4. Making and breaking the tabs of the two purity magnets, set a green circle (or a vertical stripe) in the centre of the screen.
5. Push the deflecting yoke forward, and fix it so that the entire screen becomes green.
6. Produce a horizontal line and correct the inclination of it with the deflecting yoke (do not alter the forward and rear positions of the deflecting yoke).
7. Bring the single line back.
8. Fasten the deflecting yoke so that it does not move both forward and backward (do not change the inclination or forward and rear positions of it).
9. Fasten the magnet lock tightly.
10. Produce a white screen and degauss it, then check if there is any colour shading.
 - If colour shading appears, the deflecting yoke is either leaning forward or backward, and should be corrected.

■ STATIC (CENTRE) CONVERGENCE ADJUSTMENT

Before Adjustment

1. Display a cross-hatch pattern.
2. Moving the deflecting yoke up and down and to the right and left, adjust the convergence around the periphery. Also, temporarily place a wedge on the upper part of the deflecting yoke. (Fig. 2)

Adjusting Mode

1. Overlap red and blue lines in the centre of the screen with a four-pole magnet and produce a magenta colour (Fig. 3).
2. Overlap the red/blue (magenta) line placed in the centre of the screen and the green line with a six-pole magnet.
3. Repeating 1 and 2, perfectly match the longitudinal and vertical lines located in the centre of the screen.

■ DYNAMIC (PERIPHERY) CONVERGENCE ADJUSTMENT

Adjusting Mode

1. Remove the wedge with which the deflecting yoke was temporarily fixed.
2. Oscillating the deflecting yoke up and down, set a convergence of points, L, R, T and B, on the screen and temporarily fix it with a wedge. (Fig. 4)
3. Maintaining that situation, oscillate the deflecting yoke right and left and set the convergence of points, L, R, T and B, on the screen. (Fig. 5)
4. Repeating 2 and 3, fix the position of the deflecting yoke with 4 wedges so as to produce the best condition for the convergence of points L, R, T and B, on the screen. Removable paper of the double-sided adhesive tape on inserting the wedges in order of A and B using double-sided adhesive tape after they are firmly inserted into position. (Fig. 6).
5. After completion of static-dynamic convergence adjustment, fix the magnet lock. (At this time, centre convergence might cause an aberration. If this happens, unlock it and repeat the convergence adjustment until it does not cause any aberration.)

Note 1. The double-side tape on the wedges loses adhesion once it is used. Use new tape as needed.

Note 2. When a wedge is inserted, the deflecting yoke moves slightly backward, so fix the deflecting yoke slightly forward, for the time being, prior to insertion.

Note 3. If the convergence of the points, TR, TL, BR and BL are not within the standard values, correct them with the ribbon (magnetic body). (Refer to corresponding paragraphs.)

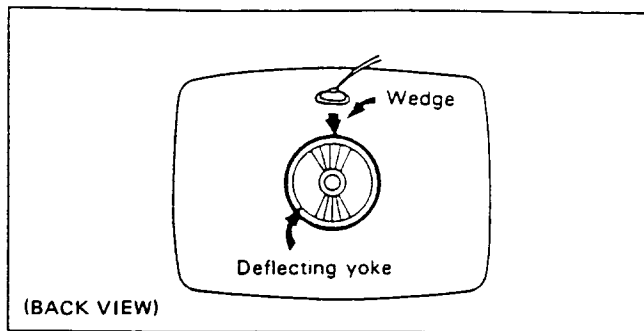

Fig. 2

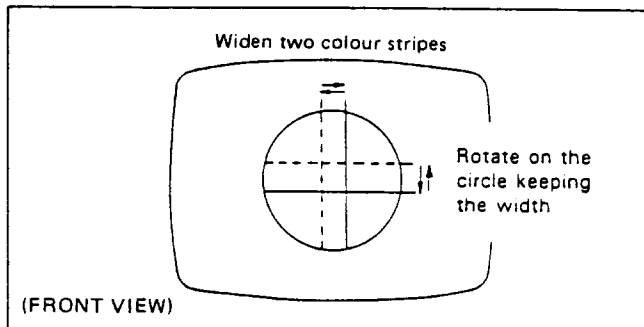

Fig. 3

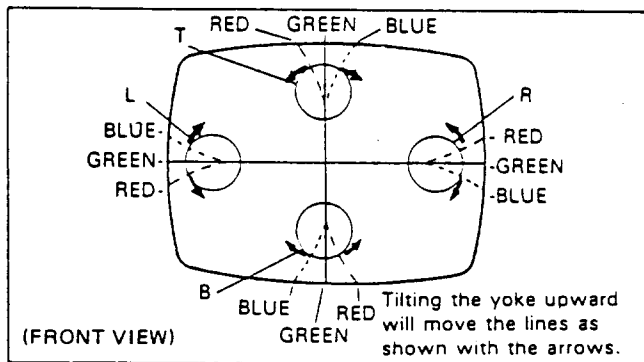

Fig. 4

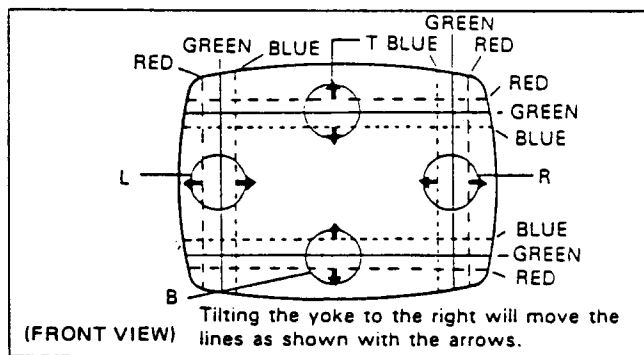

Fig. 5

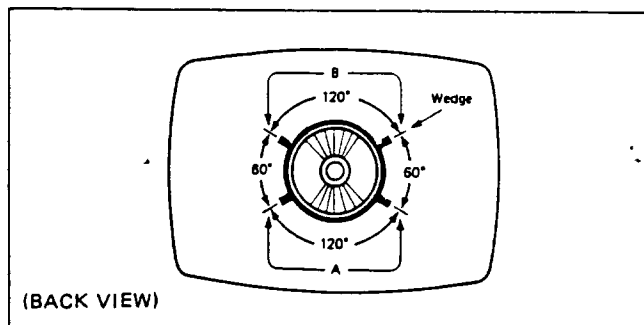

Fig. 6

■ CORRECTION MODES OF DYNAMIC (PERIPHERY) CONVERGENCE AND RIBBON (MAGNETIC MATERIAL)

- When the periphery (points TR, TL, BR, BL on the screen) convergence is nonstandardized, correct it by inserting a ribbon between the deflecting yoke and CRT funnel.
- For example, when correcting convergence of the point TR on the screen in Fig. 7, insert the ribbon in the upper-right position of the CRT facing the front. When looking at the convergence aberration of the point TR on the screen (longitudinal and vertical line), set the position of the ribbon and correct the convergence in accordance with the following steps.

1. Moving the ribbon toward the periphery, find the position where minimum aberration of the point TR is obtained. (Fig. 8)
2. Maintaining that position, adjust the depth for inserting the ribbon and correcting the quantity of convergence in order. (Fig. 9)
3. When the position for attaching the ribbon is set, fix it with double-sided adhesive tape.

Note When the ribbon is fixed in an improper location it might cause more aberration, so ensure to fix it in the correct position.

* Part No. of the ribbon: CJ40070-00A

■ AFTER COMPLETION OF PURITY-CONVERGENCE ADJUSTMENT

1. Fasten the clamp screw of the deflecting yoke tightly.
2. Wind and fasten the magnet lock tightly.
3. Coat the PC magnet with lerchlock (Fig. 10)
 - * Lerchlock Type name No. 3-C NET 200g (Manufacturer-Raihiden Kagaku Kabushikigaisha)
4. Coat silicon on the three wedges. (Fig. 10)
 - * Silicon Type name KE4866 NET 100g (Shinetsu Kagaku)

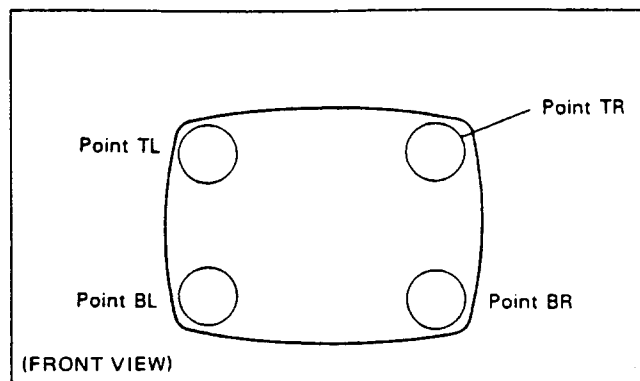

Fig. 7

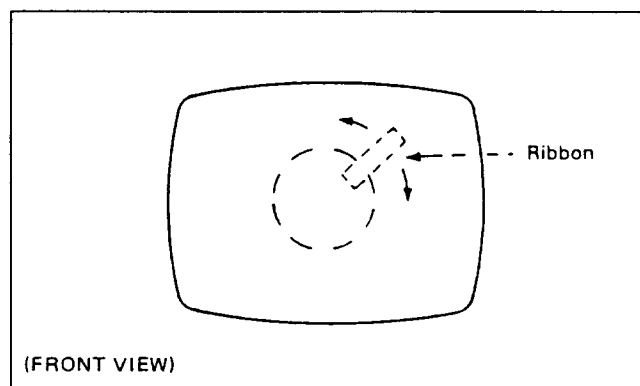

Fig. 8

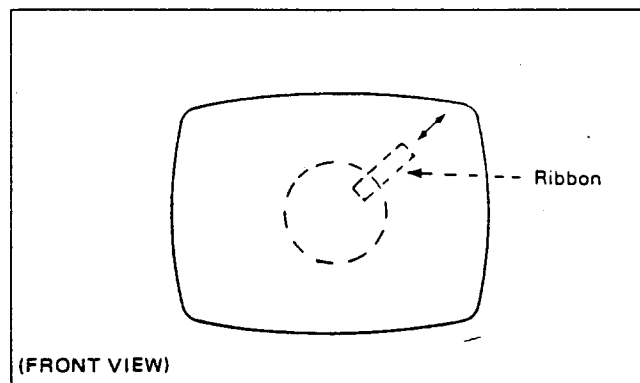

Fig. 9

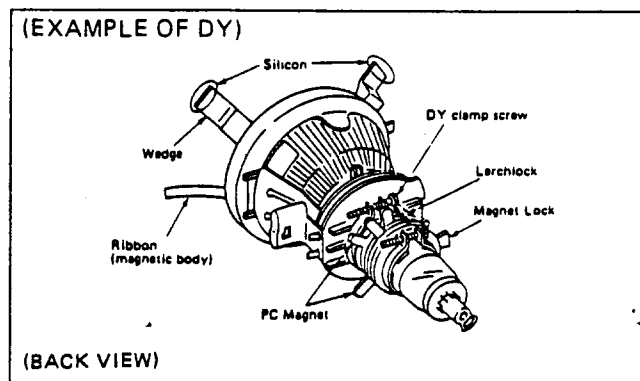

Fig. 10

REPLACEMENT PARTS LIST

REPLACEMENT PARTS LIST INFORMATION

PRODUCT SAFETY NOTE

Components identified by the Δ symbol in the PARTS LIST and the shaded areas on the Schematic have special characteristics important to safety. Before replacing any of these components read carefully the SAFETY PRECAUTION of this Service Information. DO NOT degrade the safety of the set through improper servicing.

ABBREVIATED WORD OF RESISTORS AND CAPACITORS

RESISTOR

C R : Carbon Resistor
 Comp. R : Composition Resistor
 OM R : Oxide Metal Film Resistor
 V R : Variable Resistor
 MF R : Metal Film Resistor
 CMF R : Coating Metal Film Resistor
 UNF R : Unflammable Resistor

F R : Fusible Resistor
 CH MG R : Chip Metal Glaze Resistor

CAPACITOR

C Cap. : Ceramic Capacitor
 M Cap. : Mylar Capacitor
 E Cap. : Electrolytic Capacitor

BP E Cap. : Bi-Polar (or Non-Polar) Electrolytic Capacitor
 MM Cap. : Metalized Mylar Capacitor
 PP Cap. : Polypropylene Capacitor
 MPP Cap. : Metalized PP Capacitor
 PS Cap. : Polystyrol Capacitor
 Tan. Cap. : Tantal Capacitor
 CH C Cap. : Chip Ceramic Capacitor

DECODING OF TOLERANCE AND CONSTANT TERM

TOLERANCE

J: $\pm 5\%$ K: $\pm 10\%$ M: $\pm 20\%$ N: $\pm 30\%$ H: $\begin{matrix} +50 \\ -10 \end{matrix} \%$ Z: $\begin{matrix} +80 \\ -20 \end{matrix} \%$ P: $\begin{matrix} +100 \\ -0 \end{matrix} \%$ R: $\begin{matrix} +30 \\ -10 \end{matrix} \%$ F: $\pm 1\%$

CONSTANT TERM

Carbon Resistor ($\frac{1}{4}W$, $\pm 5\%$ Tolerance)

QRD141J - $\square\square\square$

CONSTANT TERM.

- $\square\square\square$
 | | |
 1 R 0 \rightarrow 1.0 Ω $\boxed{2.7\Omega}$ \rightarrow QRD141J-2R7
 | | |
 | | |
 47k Ω \rightarrow 47×10^3 \rightarrow QRD141J-473
 | | |
 | | |
 9 R 7 \rightarrow 9.7 Ω

 1 0 \square \rightarrow 10 \square means 10×10^0 (Ω)
 | | |
 | | |
 8 2 \square \rightarrow 82 \square means 82×10^0 (Ω)

Ceramic Capacitor (50 Volts, $\pm 5\%$ Tolerance)

QCS11HJ - $\square\square\square$

CONSTANT TERM.

- $\square\square\square$
 | | |
 1 R 0 \rightarrow 1.0pF $\boxed{5pF}$ \rightarrow QCS11HJ-5R0
 | | |
 | | |
 680pF \rightarrow 68×10^1 \rightarrow QCS11HJ-681
 | | |
 | | |
 8 R 0 \rightarrow 8.0pF $\boxed{3300pF}$ \rightarrow 33×10^2 \rightarrow QCS11HJ-332

 1 0 \square \rightarrow 10 \square means 10×10^0 (pF)
 | | |
 | | |
 8 8 \square \rightarrow 88 \square means 88×10^0 (pF)

USING P.C. BOARD

MAIN P.C.B. (MSV-1219A)

CRT SOCKET P.C.B. (MSV-3000A)

CONTROL P.C.B. (MSV-4001A)

INPUT P.C.B. (MSV-4103A)

INPUT P.C.B. (MSV-6000A)

(MODULE P.C.B.)

SYNC. SIGNAL I.F. (MA-A001A-W)

■ CHASSIS & CABINET PARTS LIST

SYMBOL NO.	PART NO.	PART NAME	REMARKS
1	MA-A001A-W	SYNC. SIGNAL IF MODULE	CM1801
2	CM44490-A02	INPUT SHEET	
△ 3	AT1469SHB22EITC	ITC TUBE	Include Def York, PC Magnet, Wedge Ass'y
△ 4	CJ26891-00D	F B T	T1504
5	CJ30033-00A	WEDGE ASSY	(×4)
6	A75034-B	P&C MAGNET	
△ 7	CJ26903-00B	DEFLECTION YOKE	DY01
△ 8	CJ39691-00A	DEG. COIL	L01
9	CM32288-002	CONTROL KNOB	(×2)
△ 10	CE40811-00Q	NOISE FILTER	NF01
11	CM10765-D02-M0	BOTTOM BASE	
12	CH30302-00F	BRAIDED ASSY	
13	CH41987-00A	BRAIDED SUB ASSY	(×2)
14	CM32291-00B	FOOT	(×2)
15	CM42758-001	KNOB	(×3)
△ 16	QSE4A21-C08	SEESAW SWITCH	SW01 Power
17	CM10764-C04-M0	REAR COVER	
18	SBSB4016N	TAP SCREW	(×6)
19	CM44322-003	AC LABEL	
20	CM32485-002 (R)	ROLL R LABEL	
21	CM10641-A0U	PEDESTAL ASSY	
22	CM40498-005	KNOB CAP	(×2)
23	CM32289-F01	CONTROL BASE	
100	CM11048-A0F-M0	FRONT PANEL ASSY	Include No. 101-102
101	CM44437-001	LED LENS	
102	CM45971-001	NAME PLATE	

[EXPLODED VIEW]

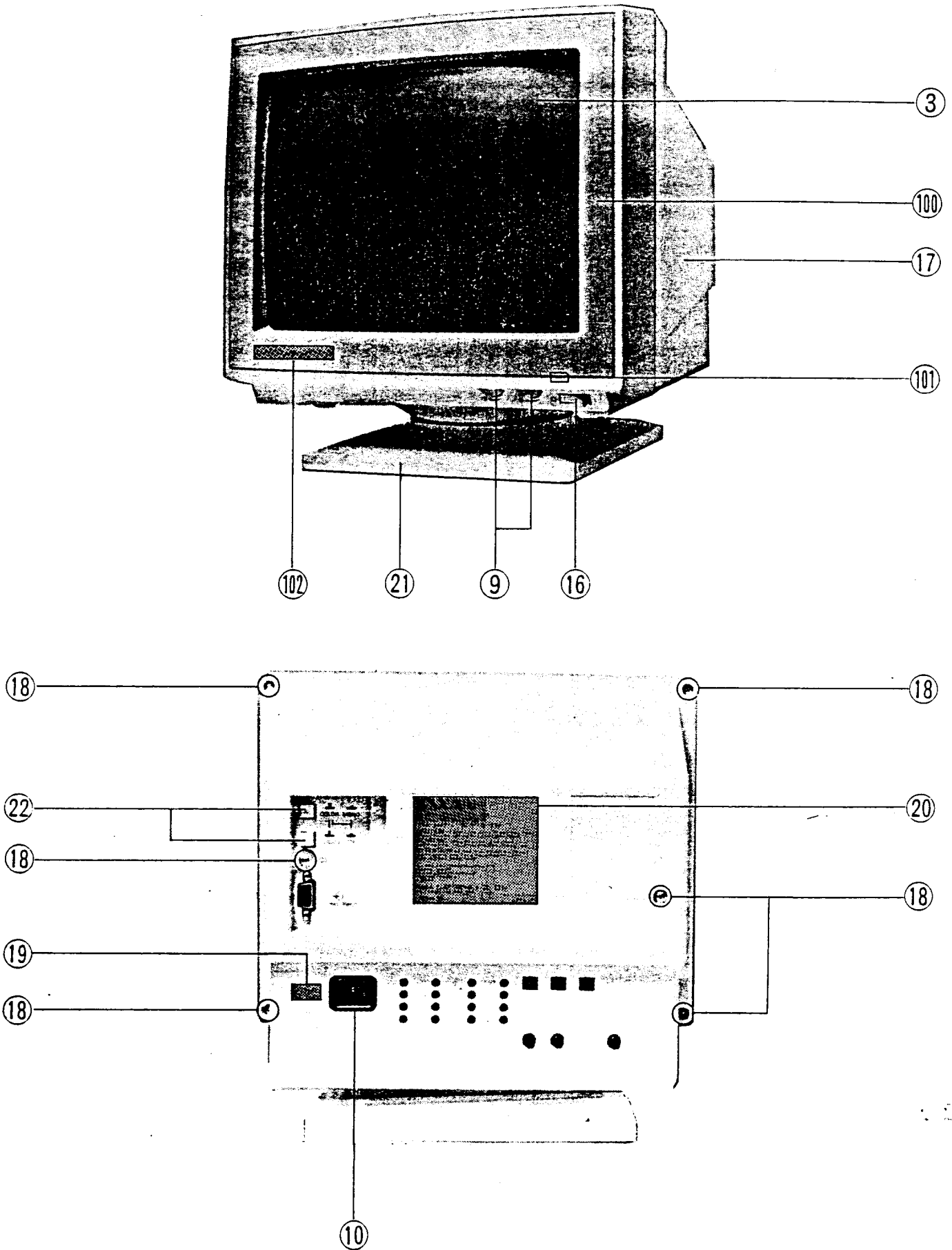

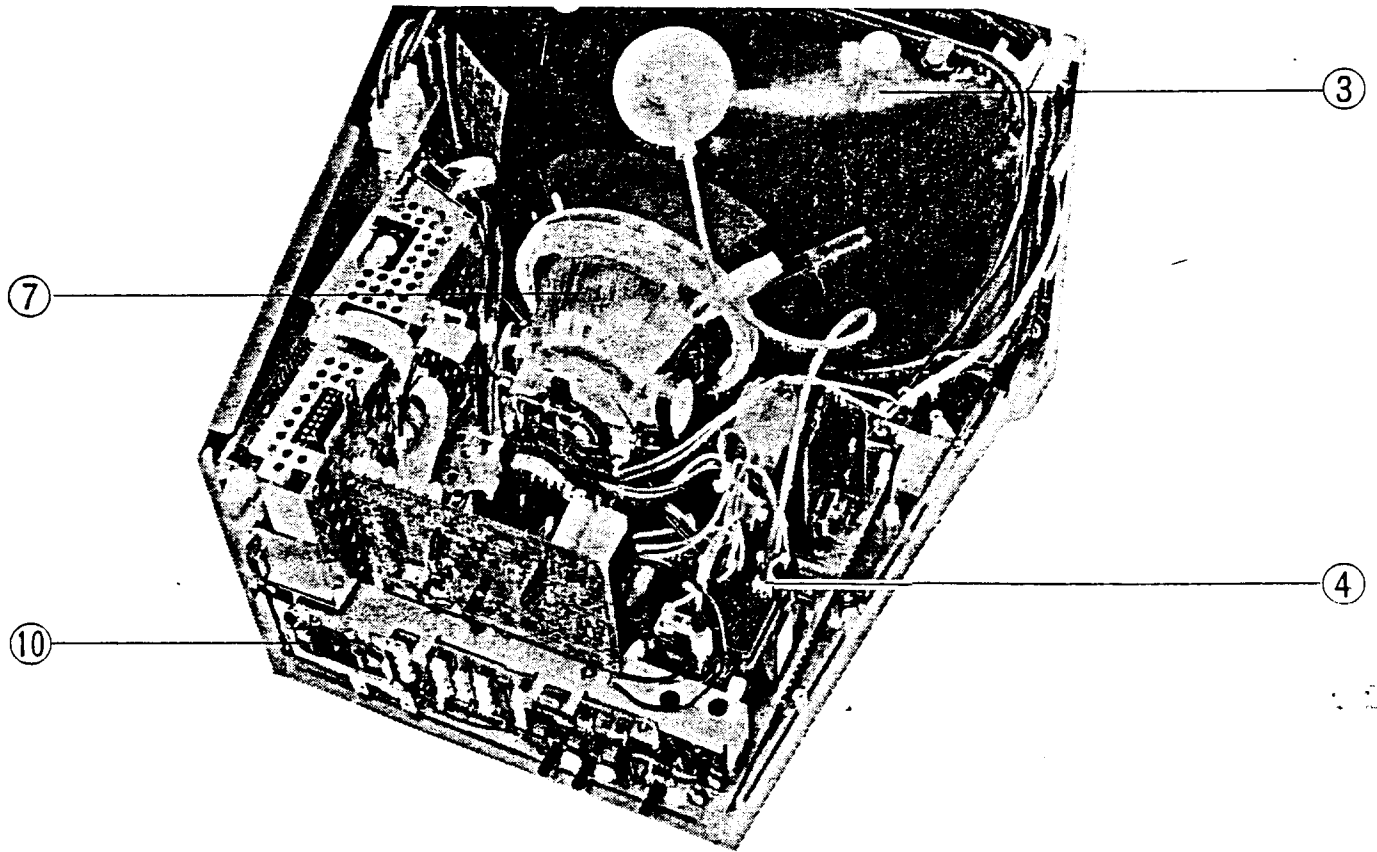
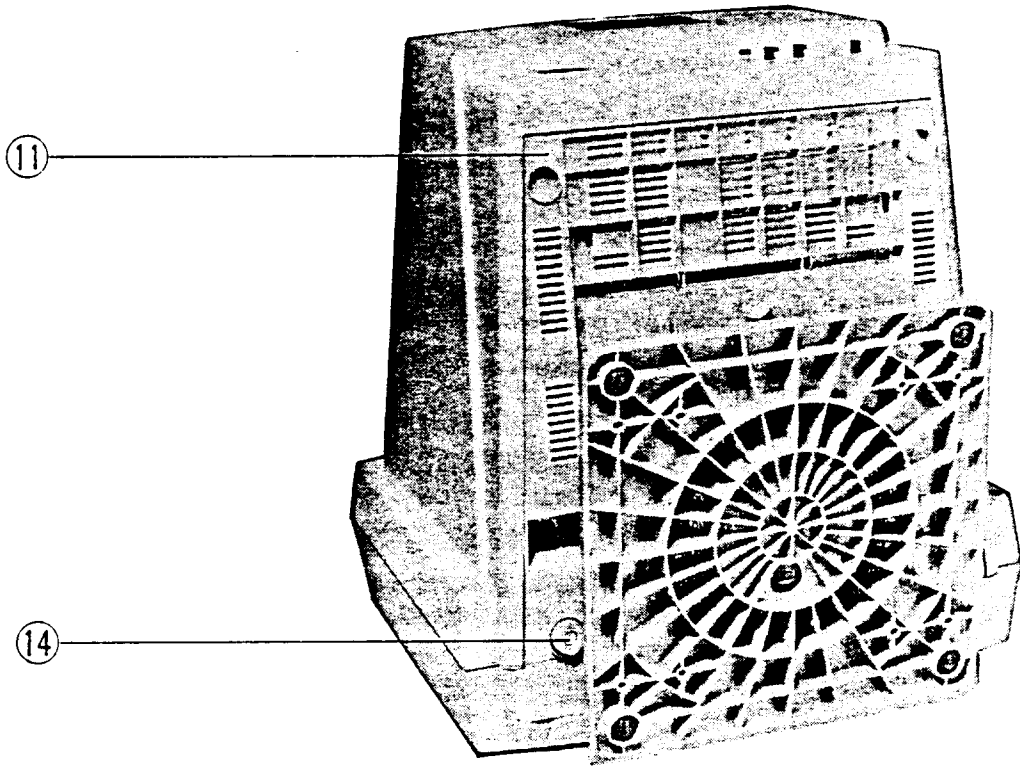

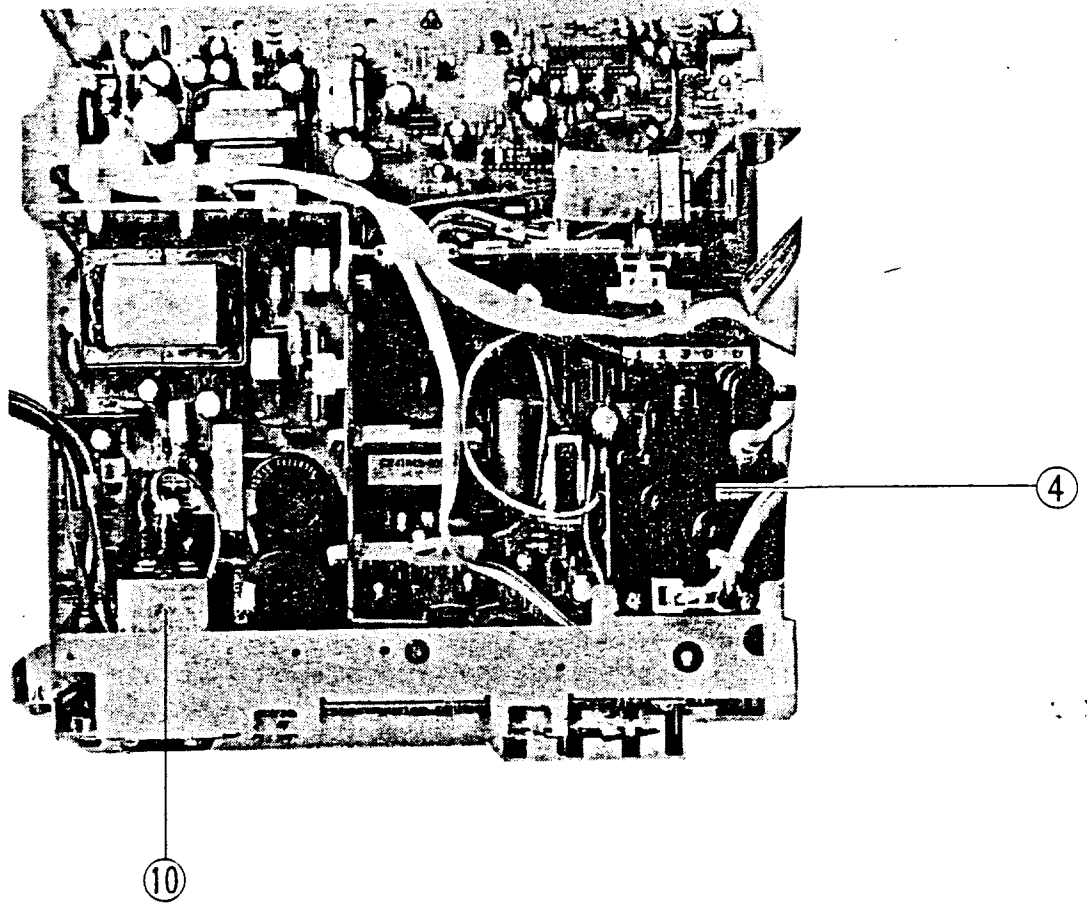
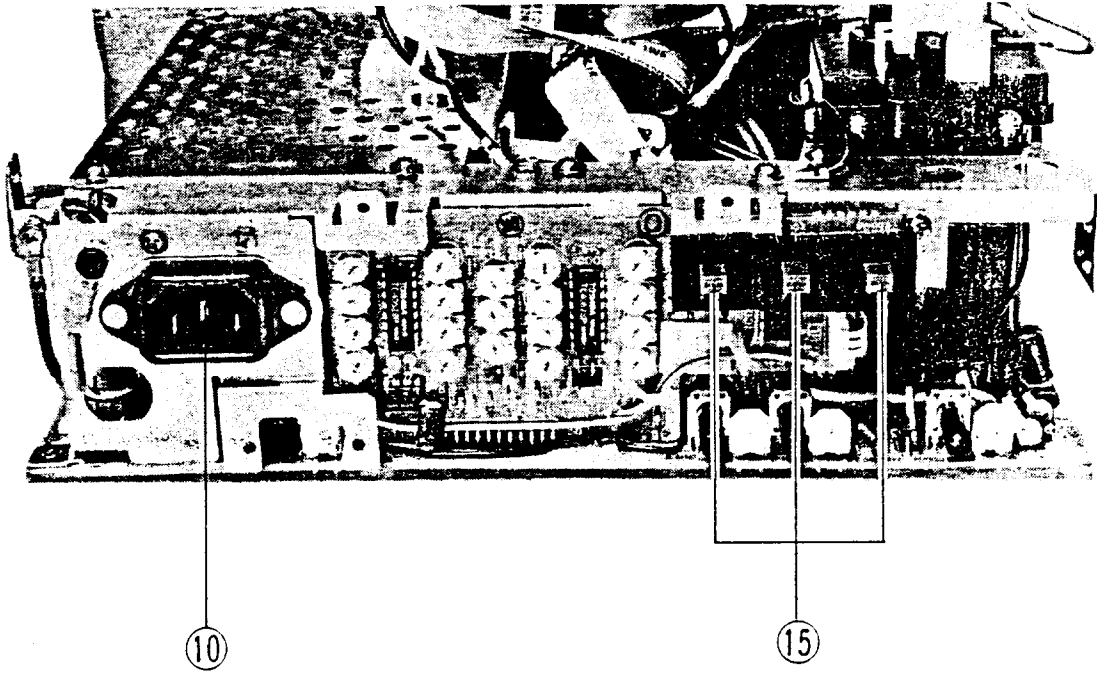

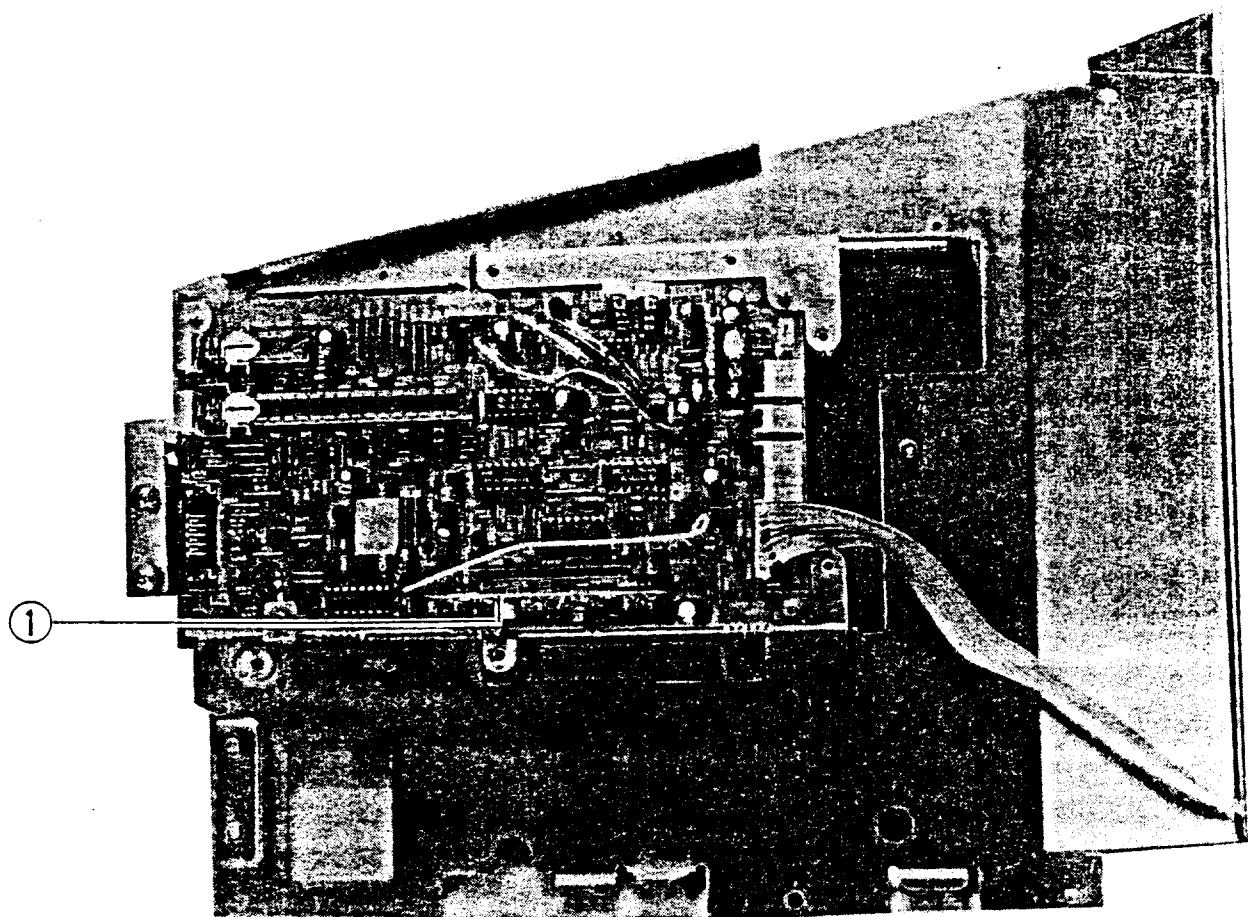
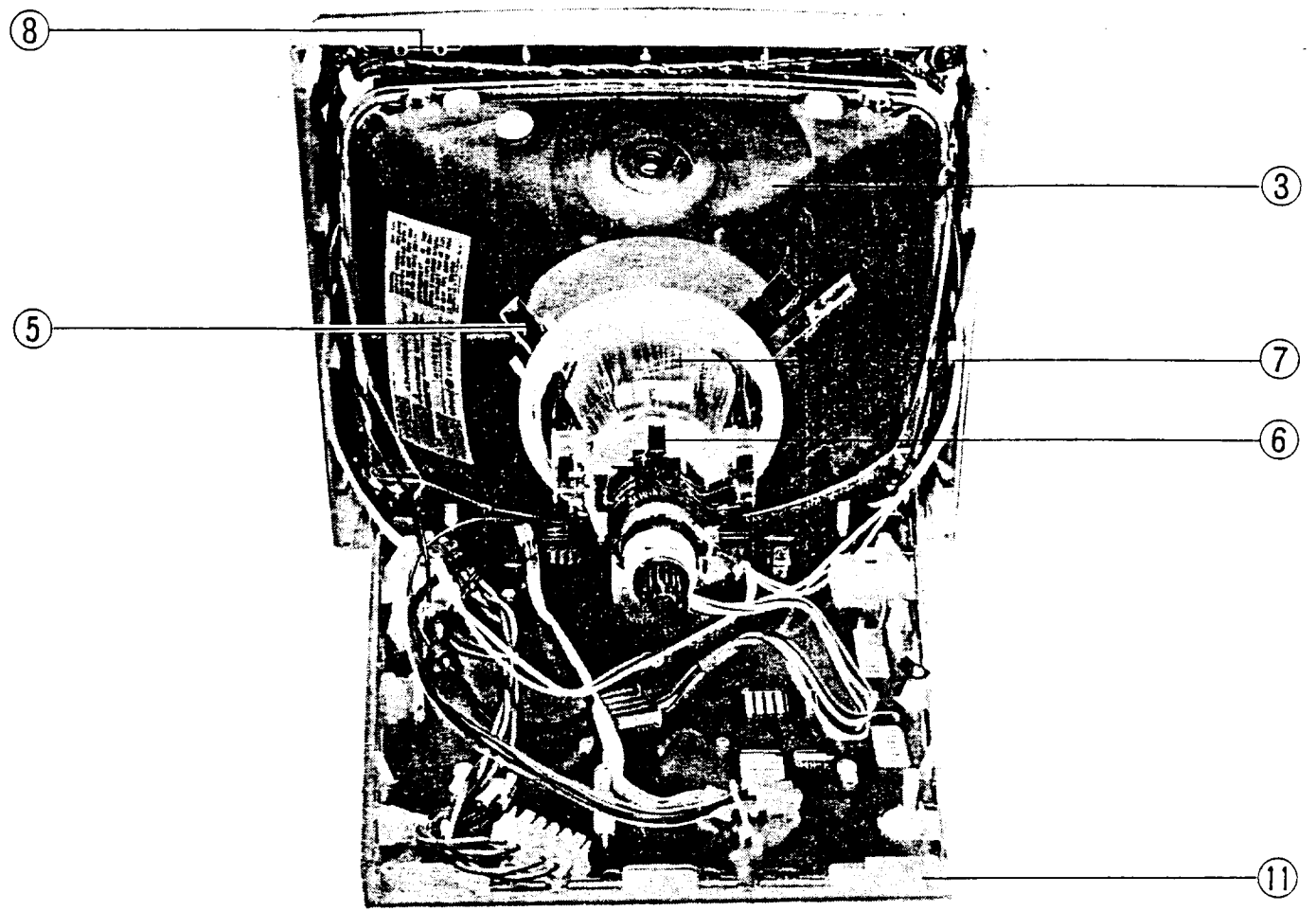

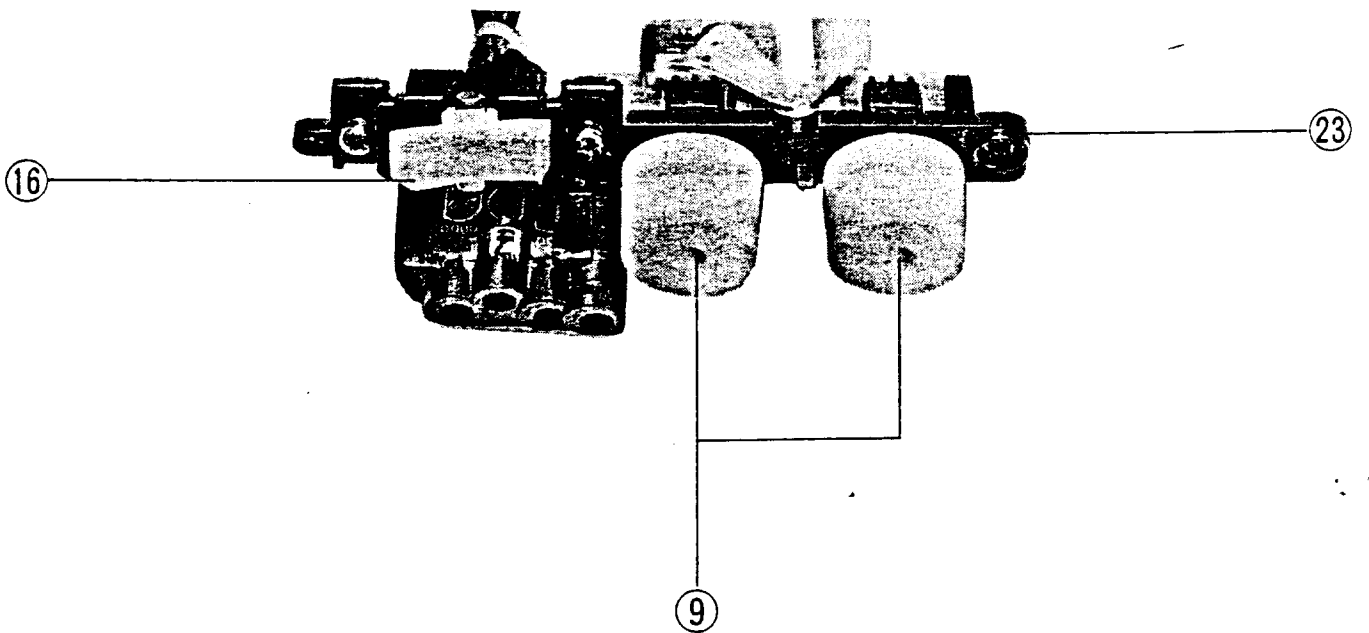
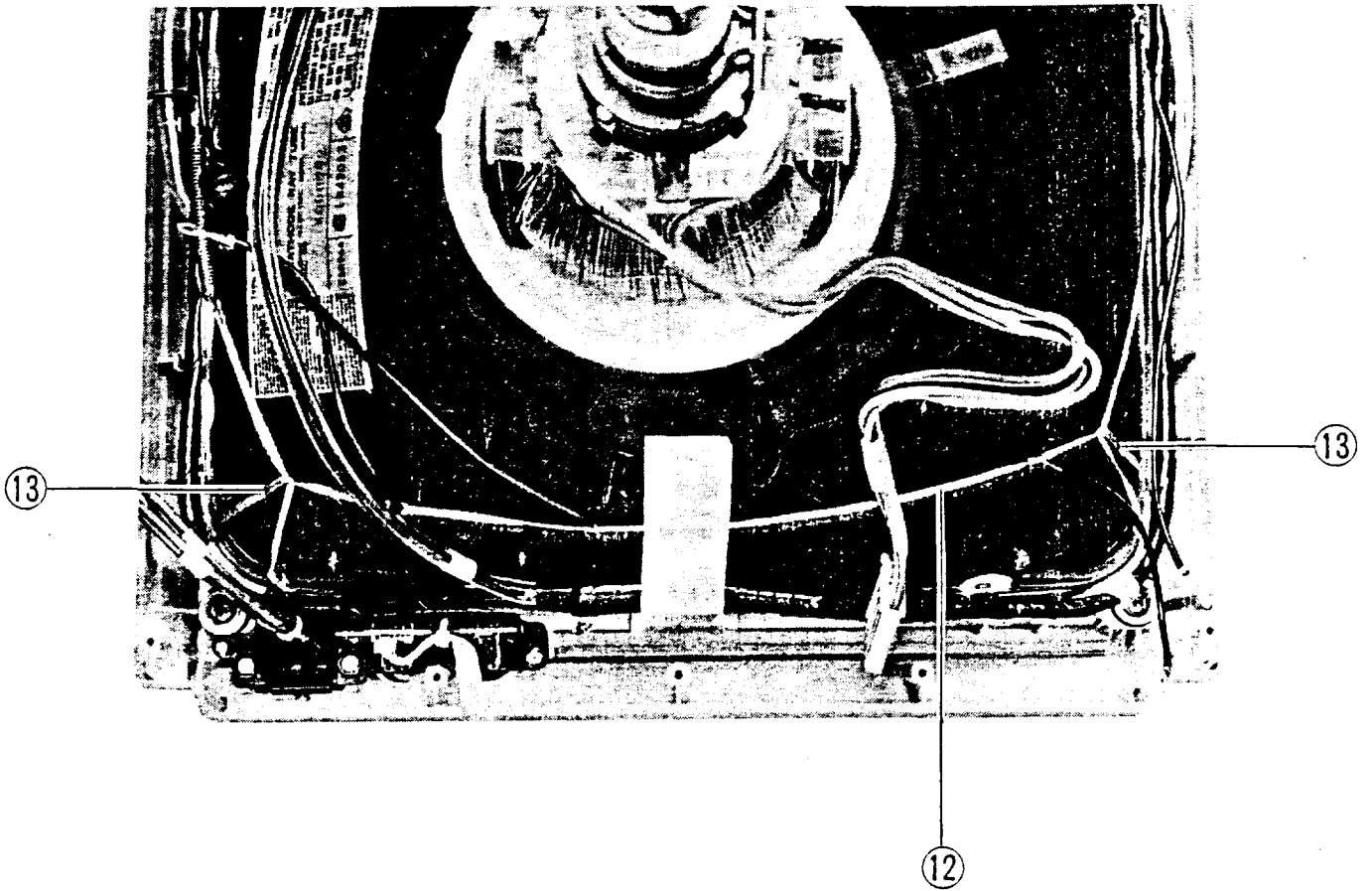

MAIN P.C.B. (MSV-1219A)

SYMBOL NO.	PART NO.	PART NAME	REMARKS		
VARIABLE RESISTOR					
R1007	QVPE806-502H	V R (SUB BRIGHT)	5 k Ω	B	
R1407	QVAA002-CB24A	V R (V. SIZE)	20 k Ω	B	
R1409	QVAA002-CB24A	V R (V. POSI)	20 k Ω	B	
R1428	QVPE806-501H	V R (HEIGHT)	500 Ω	B	
R1430	QVPE806-501H	V R (V. LIN)	500 Ω	B	
R1446	QVPE806-502H	V R (SPCC)	5 k Ω	B	
R1471	QV23211-052	V R (V. CENTOR)	500 Ω	B	
R1511	QVAA002-CB24A	V R (H. POSI)	20 k Ω	B	
R1521	QVPE806-503H	V R (H. FREQ)	50 k Ω	B	
R1539	QVPE806-202H	V R (IIV ADJ)	2 k Ω	B	
R1920	QVPE806-203H	V R (BI ADJ)	30 k Ω	B	
RESISTOR					
R1002	QRD161J-472Y	C R	4.7 k Ω	1/6W	J
R1003	QRD161J-105Y	C R	1M Ω	1/6W	J
R1004	QRD161J-223Y	C R	22 k Ω	1/6W	J
R1009	QRD162J-472	C R	4.7 k Ω	1/6W	J
R1401	QRD161J-473Y	C R	47 k Ω	1/6W	J
R1402	QRD161J-562Y	C R	5.6 k Ω	1/6W	J
R1403	QRD161J-153Y	C R	15 k Ω	1/6W	J
R1404	QRD141J-683SY	C R	68 k Ω	1/4W	J
R1405	QRD161J-562Y	C R	5.6 k Ω	1/6W	J
R1406	QRD161J-104Y	C R	100 k Ω	1/6W	J
R1408	QRD161J-474Y	C R	470 k Ω	1/6W	J
R1410	QRD161J-563Y	C R	56 k Ω	1/6W	J
R1411	QRD161J-101Y	C R	100 Ω	1/6W	J
R1412	QRD161J-104Y	C R	100 k Ω	1/6W	J
R1413	QRD161J-393Y	C R	39 k Ω	1/6W	J
R1414	QRD161J-103Y	C R	10 k Ω	1/6W	J
R1416	QRD161J-393Y	C R	39 k Ω	1/6W	J
R1417	QRD161J-224Y	C R	220 k Ω	1/6W	J
R1418	QRD161J-104Y	C R	100 k Ω	1/6W	J
R1419	QRD161J-104Y	C R	100 k Ω	1/6W	J
R1420	QRD161J-222Y	C R	2.2 k Ω	1/6W	J
R1421	QRD161J-473Y	C R	47 k Ω	1/6W	J
R1422	QRD161J-220Y	C R	22 Ω	1/6W	J
R1423	QRD161J-392Y	C R	3.9 k Ω	1/6W	J
R1424	QRD161J-681Y	C R	680 Ω	1/6W	J
R1425	QRD141J-822SY	C R	8.2 k Ω	1/4W	J
R1426	QRD161J-103Y	C R	10 k Ω	1/6W	J
R1427	QRD141J-562SY	C R	5.6 k Ω	1/4W	J
R1429	QRD141J-102SY	C R	1 k Ω	1/4W	J
R1431	QRD161J-183Y	C R	18 k Ω	1/6W	J
R1432	QRD161J-473Y	C R	47 k Ω	1/6W	J
R1435	QRD161J-224Y	C R	220 k Ω	1/6W	J
R1436	QRD161J-474Y	C R	470 k Ω	1/6W	J
R1437	QRD161J-183Y	C R	18 k Ω	1/6W	J
R1438	QRD161J-103Y	C R	10 k Ω	1/6W	J
R1439	QRD161J-101Y	C R	100 Ω	1/6W	J
R1440	QRD121J-2R2SY	C R	2.2 Ω	1/2W	J
R1441	QRD121J-271SY	C R	270 Ω	1/2W	J
R1442	QRD161J-332Y	C R	3.3 k Ω	1/6W	J
R1443	QRD161J-101Y	C R	100 Ω	1/6W	J
R1444	QRD161J-393Y	C R	39 k Ω	1/6W	J
R1445	QRD161J-560Y	C R	56 Ω	1/6W	J
R1447	QRD161J-271Y	C R	270 Ω	1/6W	J
R1448	QRD161J-220Y	C R	22 Ω	1/6W	J
R1449	QRD161J-472Y	C R	4.7 k Ω	1/6W	J
R1450	QRD161J-393Y	C R	39 k Ω	1/6W	J

MSV-1219A

SYMBOL NO.	PART NO.	PART NAME	REMARKS
RESISTOR			
R1451	QRD161J-683Y	C R	68k Ω 1/6W J
R1452	QRD161J-104Y	C R	100k Ω 1/6W J
R1453	QRD161J-154Y	C R	150k Ω 1/6W J
R1454	QRD161J-105Y	C R	1M Ω 1/6W J
R1455	QRD161J-393Y	C R	39k Ω 1/6W J
R1456	QRD161J-103Y	C R	10k Ω 1/6W J
R1457	QRD161J-560Y	C R	56 Ω 1/6W J
R1458	QRD161J-103Y	C R	10k Ω 1/6W J
R1459	QRD161J-392Y	C R	3.9k Ω 1/6W J
R1460	QRD161J-222Y	C R	2.2k Ω 1/6W J
R1461	QRD161J-682Y	C R	6.8k Ω 1/6W J
R1462	QRD161J-471Y	C R	470 Ω 1/6W J
R1463	QRD161J-222Y	C R	2.2k Ω 1/6W J
R1464	QRD161J-221Y	C R	220 Ω 1/6W J
R1469	QRD123J-471SX	C R	470 Ω 1/2W J
R1470	QRD123J-471SX	C R	470 Ω 1/2W J
R1472	QRD161J-154Y	C R	150k Ω 1/6W J
R1473	QRD161J-333Y	C R	33k Ω 1/6W J
R1475	QRD161J-104Y	C R	100k Ω 1/6W J
R1476	QRD161J-152Y	C R	1.5k Ω 1/6W J
R1477	QRD161J-224	C R	220k Ω 1/6W J
R1478	QRD121J-102S	C R	1k Ω 1/2W J
R1501	QRD141J-102SY	C R	1k Ω 1/4W J
R1502	QRD141J-103SY	C R	10k Ω 1/4W J
R1503	QRD161J-273Y	C R	27k Ω 1/6W J
R1504	QRD161J-562Y	C R	5.6k Ω 1/6W J
R1505	QRD143J-221SX	C R	220 Ω 1/4W J
R1506	QRD161J-472Y	C R	4.7k Ω 1/6W J
R1507	QRD161J-223Y	C R	22k Ω 1/6W J
R1508	QRD161J-223Y	C R	22k Ω 1/6W J
R1509	QRD161J-474Y	C R	470k Ω 1/6W J
R1510	QRD161J-474Y	C R	470k Ω 1/6W J
R1512	QRD161J-103Y	C R	10k Ω 1/6W J
R1513	QRD121J-152SY	C R	1.5k Ω 1/2W J
R1514	QRD161J-153Y	C R	15k Ω 1/6W J
R1515	QRD161J-182Y	C R	1.8k Ω 1/6W J
R1516	QRD161J-103Y	C R	10k Ω 1/6W J
R1517	QRD161J-183Y	C R	18k Ω 1/6W J
R1518	QRD161J-223Y	C R	22k Ω 1/6W J
R1519	QRD161J-103Y	C R	10k Ω 1/6W J
R1520	QRD161J-103Y	C R	10k Ω 1/6W J
R1522	QRD161J-683Y	C R	68k Ω 1/6W J
R1523	QRD161J-222Y	C R	2.2k Ω 1/6W J
R1524	QRD161J-182Y	C R	1.8k Ω 1/6W J
R1525	QRD161J-682Y	C R	6.8k Ω 1/6W J
R1526	QRD161J-683Y	C R	68k Ω 1/6W J
R1527	QRD141J-470SY	C R	47 Ω 1/4W J
R1528	QRD161J-472Y	C R	4.7k Ω 1/6W J
R1529	QRD141J-223SY	C R	22k Ω 1/4W J
R1530	QRD161J-822Y	C R	8.2k Ω 1/6W J
R1531	QRD161J-222Y	C R	2.2k Ω 1/6W J
R1532	QRD161J-332Y	C R	3.3k Ω 1/6W J
R1533	QRD161J-102Y	C R	1k Ω 1/6W J
R1534	QRD141J-224SY	C R	220k Ω 1/4W J
R1535	QRD161J-272Y	C R	2.7k Ω 1/6W J
R1536	QRD161J-272Y	C R	2.7k Ω 1/6W J
R1537	QRD162J-562	C R	5.6k Ω 1/6W J
R1538	QRD161J-682Y	C R	6.8k Ω 1/6W J

MSV-1219A

SYMBOL NO.	PART NO.	PART NAME	REMARKS
RESISTOR			
△ R1540	QRV141F-5901Y	MF R	5.9kΩ 1/4W F
△ R1541	QRV141F-6802Y	MF R	68kΩ 1/4W F
R1542	QRD141J-183SY	C R	18kΩ 1/4W J
R1543	QRD161J-103Y	C R	10kΩ 1/6W J
R1544	QRX019J-R68S	MF R	0.68 Ω 1W J
R1545	QRC019J-470S	OM R	47 Ω 1W J
R1546	QRD123J-270SX	C R	27 Ω 1/2W J
R1547	QRD141J-221SY	C R	220 Ω 1/4W J
R1548	QRD161J-223Y	C R	22kΩ 1/6W J
R1549	QRD161J-332Y	C R	3.3kΩ 1/6W J
R1550	QRD121J-561SY	C R	560 Ω 1/2W J
R1551	QRD161J-223Y	C R	22kΩ 1/6W J
R1552	QRD161J-152Y	C R	1.5kΩ 1/6W J
R1553	QRD161J-102Y	C R	1kΩ 1/6W J
R1554	QRD161J-151Y	C R	150 Ω 1/6W J
R1555	QRD141J-561SY	C R	560 Ω 1/4W J
R1556	QRC029J-471	OM R	470 Ω 2W J
R1558	QRD161J-123Y	C R	12kΩ 1/6W J
R1559	QRD161J-392Y	C R	3.9kΩ 1/6W J
R1560	QRD161J-272Y	C R	2.7kΩ 1/6W J
R1561	QRD161J-102Y	C R	1kΩ 1/6W J
R1562	QRD161J-272Y	C R	2.7kΩ 1/6W J
R1563	QRD161J-224Y	C R	220kΩ 1/6W J
R1564	QRD161J-682Y	C R	6.8kΩ 1/6W J
R1565	QRD121J-820SY	C R	82 Ω 1/2W J
R1566	QRD121J-680SY	C R	68 Ω 1/2W J
R1567	QRD161J-224Y	C R	220kΩ 1/6W J
R1568	QRD161J-682Y	C R	6.8kΩ 1/6W J
R1569	QRD161J-152Y	C R	1.5kΩ 1/6W J
R1570	QRD161J-271Y	C R	270 Ω 1/6W J
R1571	QRD161J-271Y	C R	270 Ω 1/6W J
R1572	QRC019J-391S	OM R	390 Ω 1W J
R1573	QRD161J-470Y	C R	47 Ω 1/6W J
R1574	QRC039J-102	OM R	1kΩ 3W J
R1575	QRD161J-470Y	C R	47 Ω 1/6W J
R1576	QRD161J-333Y	C R	33kΩ 1/6W J
R1577	QRD161J-273	C R	27kΩ 1/6W J
R1578	QRD121J-470SY	C R	47 Ω 1/2W J
R1579	QRD121J-150SY	C R	15 Ω 1/2W J
R1580	QRD161J-124Y	C R	120kΩ 1/6W J
R1581	QRD141J-101SY	C R	100 Ω 1/4W J
R1582	QRX019J-8R2	MF R	8.2 Ω 1W J
R1583	QRD141J-101SY	C R	100 Ω 1/4W J
R1584	QRD161J-222Y	C R	2.2kΩ 1/6W J
R1585	QRD161J-123Y	C R	12kΩ 1/6W J
R1586	QRD121J-220SY	C R	22 Ω 1/2W J
R1587	QRD123J-330SX	C R	33 Ω 1/2W J
R1588	QRD123J-470SX	C R	47 Ω 1/2W J
R1902	QRC039J-473A	OM R	47kΩ 3W J
R1904	QRZ0079-8R2	UNF R	8.2 Ω 7W K
R1905	QRM055K-R22	MP R	0.22 Ω 5W K
R1906	QRM055K-R47	MP R	0.47 Ω 5W K
R1907	QRD121J-124SY	C R	120kΩ 1/2W J
R1908	QRC122K-104	COMP. R	100kΩ 1/2W K
R1909	QRD121J-104SY	C R	100kΩ 1/2W J
R1910	QRD121J-104SY	C R	100kΩ 1/2W J
R1911	QRZ0069-472	UNF R	4.7kΩ 5W K
R1912	QRD161J-103Y	C R	10kΩ 1/6W J

MSV-1219A

SYMBOL NO.	PART NO.	PART NAME	REMARKS		
RESISTOR					
R1913	QRC029J-220A	OM R	22 Ω	2W	J
R1915	QRD161J-472Y	C R	4.7k Ω	1/6W	J
R1916	QRD161J-392Y	C R	3.9k Ω	1/6W	J
R1917	QRD161J-102Y	C R	1k Ω	1/6W	J
Δ R1918	QRV141F-2702AY	MF R	27k Ω	1/4W	F
R1921	QRD121J-124SY	C R	120k Ω	1/2W	J
R1922	QRC122K-104	COMP. R	100k Ω	1/2W	K
Δ R1924	QRV141F-5601AY	MF R	5.6k Ω	1/4W	F
R1925	QRD161J-1R0Y	C R	1.0 Ω	1/6W	J
R1926	QRD161J-1R0Y	C R	1.0 Ω	1/6W	J
R1927	QRD161J-223Y	C R	22k Ω	1/6W	J
R1930	QRD123J-561SX	C R	560 Ω	1/2W	J
R1931	QRD121J-102SY	C R	1k Ω	1/2W	J
R1932	QRM055K-R47	MP R	0.47 Ω	5W	K
R1934	QRD121J-273SY	C R	27k Ω	1/2W	J
CAPACITOR					
C1001	QETC1HM-335Z	E CAP.	3.3 μ F	50V	M
C1002	QETC1CM-107Z	E CAP.	100 μ F	16V	M
C1401	QFZ0083-683MZ	M CAP.	0.068 μ F	50V	K
C1407	QFV71HJ-224MZ	TF CAP.	0.22 μ F	50V	J
C1408	QEH61HM-474MZ	E CAP.	0.47 μ F	50V	M
C1409	QCY31HK-472AZ	C CAP.	4700pF	50V	K
C1410	QCS32HJ-151UZ	C CAP.	150pF	500V	J
C1411	QEH61VM-107MZ	E CAP.	100 μ F	35V	M
C1412	QEM61EK-226MZ	E CAP.	22 μ F	25V	K
C1413	QFM71HK-183MZ	M CAP.	0.018 μ F	50V	K
C1414	QEE61VK-105BZ	TAN. CAP.	1 μ F	35V	K
C1415	QFM71HK-273MZ	M CAP.	0.027 μ F	50V	K
C1416	QETB1CM-227	E CAP.	220 μ F	16V	M
C1417	QEB61HM-104MZ	E CAP.	0.1 μ F	50V	M
C1418	QFM71HK-223MZ	M CAP.	0.022 μ F	50V	K
C1419	QEH61HM-474MZ	E CAP.	0.47 μ F	50V	M
C1420	QEN61HM-474Z	BP E CAP.	0.47 μ F	50V	M
C1421	QEH61EM-108M	E CAP.	1000 μ F	25V	M
C1422	QFV71HJ-563MZ	TF CAP.	0.056 μ F	50V	J
C1423	QFM71HK-103M	M CAP.	0.01 μ F	50V	K
C1424	QETC1CM-107Z	E CAP.	100 μ F	16V	M
C1425	QETC1EM-226Z	E CAP.	22 μ F	25V	M
C1426	QEN61HM-105Z	BP E CAP.	1 μ F	50V	M
C1427	QETC1HM-105Z	E CAP.	1 μ F	50V	M
C1428	QCS31HJ-331AZ	C CAP.	330pF	50V	J
C1429	QEH61CM-336MZ	E CAP.	33 μ F	16V	M
C1431	QEN61HM-474Z	BP E CAP.	0.47 μ F	50V	M
C1432	QETC1HM-105Z	E CAP.	1 μ F	50V	M
C1433	QCS31HJ-681AZ	C CAP.	680pF	50V	J
C1435	QCS31HJ-471MZ	C CAP.	470pF	50V	J
C1436	QEH61HM-225MZ	E CAP.	2.2 μ F	50V	M
C1437	QEH61VM-108M	E CAP.	1000 μ F	35V	M
C1438	QFM71HJ-332M	M CAP.	3300pF	50V	J
C1501	QEN61HM-105Z	BP E CAP.	1 μ F	50V	M
C1502	QETC1HM-105Z	E CAP.	1 μ F	50V	M
C1503	QFP31HJ-152SZ	PP CAP.	1500pF	50V	J
C1504	QEN61HM-335Z	BP E CAP.	3.3 μ F	50V	M
C1505	QFP31HJ-102SZ	PP CAP.	1000pF	50V	J
C1506	QETC1CM-106Z	E CAP.	10 μ F	16V	M
C1507	QETB2CM-476	E CAP.	47 μ F	160V	M
C1508	QETC1HM-335Z	E CAP.	3.3 μ F	50V	M
C1509	QEN61HM-335Z	BP E CAP.	3.3 μ F	50V	M

MSV-1219A

SYMBOL NO.	PART NO.	PART NAME	REMARKS		
CAPACITOR					
C1510	QEHC1HM-105MZ	E CAP.	1 μ F	50V	M
C1511	QETC1CM-106Z	E CAP.	10 μ F	16V	M
C1512	QFP32AG-102MZ	PP CAP.	1000 pF	100V	G
C1513	QCS31HJ-221AZ	C CAP.	220 pF	50V	J
C1514	QETC1HM-105Z	E CAP.	1 μ F	50V	M
C1515	QFM71HK-222MZ	M CAP.	2200 pF	50V	K
C1516	QFP32AG-222MZ	PP CAP.	2200 pF	100V	G
C1517	QFM71HK-393MZ	M CAP.	0.039 μ F	50V	K
C1518	QFM71HK-822MZ	M CAP.	8200 pF	50V	K
C1519	QETC1CM-477Z	E CAP.	470 μ F	16V	M
C1520	QETC1CM-108Z	E CAP.	1000 μ F	16V	M
C1521	QEHC1CM-106MZ	E CAP.	10 μ F	16V	M
C1522	QFM71HK-103MZ	M CAP.	0.01 μ F	50V	K
C1523	QETC1HM-105Z	E CAP.	1 μ F	50V	M
C1524	QEN41HM-225	BP E CAP.	2.2 μ F	50V	M
C1525	QFM72AK-563M	M CAP.	0.056 μ F	100V	K
C1526	QFM72AK-223M	M CAP.	0.022 μ F	100V	K
C1527	QFM72AK-223MZ	M CAP.	0.022 μ F	100V	K
C1528	QCS32HJ-151UZ	C CAP.	150 pF	500V	J
C1529	QETC1EM-336Z	E CAP.	33 μ F	25V	M
C1530	QFZ0091-355S	MPP CAP.	3.5 μ F	160V	K
C1531	QETC1HM-105Z	E CAP.	1 μ F	50V	M
C1532	QCY32HK-471AZ	C CAP.	470 pF	500V	K
C1533	QETB2CM-107	E CAP.	100 μ F	160V	M
C1534	QETC1CM-477Z	E CAP.	470 μ F	16V	M
C1536	QETC1VM-107Z	E CAP.	100 μ F	35V	M
C1537	QFM71HK-152MZ	M CAP.	1500 pF	50V	K
C1538	QFV71HJ-104MZ	TF CAP.	0.1 μ F	50V	J
C1539	QETC1CM-107Z	E CAP.	100 μ F	16V	M
C1540	QFM72DJ-102MZ	M CAP.	1000 pF	200V	J
C1541	QFP42JJ-332M	PP CAP.	3300 pF	630V	J
△ C1542	QFZ0081-3101S	PP CAP.	3100 pF	1600V	±3%
△ C1543	QFM72DK-562MZ	M CAP.	5600 pF	200V	K
△ C1544	QFZ0081-3601S	MPP CA.	3600 pF	1600V	±3%
△ C1545	QFZ0081-3701S	MPP CAP.	3700 pF	1600V	±3%
△ C1546	QFZ0081-3501S	PP CAP.	3500 pF	1600V	±3%
C1547	QFK62AK-224MZ	MM CAP.	0.22 μ F	100V	K
C1548	QETC1CM-336Z	E CAP.	33 μ F	16V	M
C1549	QEHB1CM-108M	E CAP.	1000 μ F	16V	M
C1550	QETC1CM-227Z	E CAP.	220 μ F	16V	M
C1551	QETC1HM-105Z	E CAP.	1 μ F	50V	M
C1552	QETB1CM-108	E CAP.	1000 μ F	16V	M
C1555	QFM71HK-103MZ	M CAP.	0.01 μ F	50V	K
C1556	QFM71HK-103MZ	M CAP.	0.01 μ F	50V	K
C1557	QETA2CM-106	E CAP.	10 μ F	160V	M
C1558	QETC1CM-476Z	E CAP.	47 μ F	16V	M
C1559	QCS12HJ-151A	C CAP.	150 pF	500V	J
△ C1901	QFZ9022-224M	MF CAP.	0.22 μ F	AC250V	M
△ C1903	QCZ9033-103A	C CAP.	0.01 μ F	AC400V	P
△ C1904	QFZ9022-104M	MF CAP.	0.1 μ F	AC250V	M
△ C1905	QFZ9022-224M	MF CAP.	0.22 μ F	AC250V	M
△ C1906	QCZ9033-103A	C CAP.	0.01 μ F	AC400V	P
△ C1907	QCZ9033-103A	C CAP.	0.01 μ F	AC400V	P
C1910	QEZ0084-227R	E CAP.	220 μ F	400V	M
C1911	QEZ0084-227R	E CAP.	220 μ F	400V	M
C1912	QFH62EK-223M	MM CAP.	0.022 μ F	250V	K
C1913	QEM51AM-477M	E CAP.	470 μ F	10V	M
C1914	QEH52CM-107M	E CAP.	100 μ F	160V	M

MSV-1219A

SYMBOL NO	PART NO.	PART NAME	REMARKS
CAPACITOR			
C1915	QEHB1EM-477M	E CAP.	470 μ F 25V M
C1916	QFM71HK-332MZ	M CAP.	3300pF 50V K
C1917	QFP31HG-822SZ	PP CAP.	8200pF 50V G
C1918	QEH52CM-107M	E CAP.	100 μ F 160V M
C1919	QEH52CM-107M	E CAP.	100 μ F 160V M
C1920	QEH61HM-105MZ	E CAP.	1 μ F 50V M
C1922	QEH61CM-108M	E CAP.	1000 μ F 16V M
C1923	QETB1VM-337	E CAP.	330 μ F 35V M
C1924	QEM61EK-226MZ	E CAP.	22 μ F 25V K
C1925	QETC1VM-107Z	E CAP.	100 μ F 35V M
C1926	QFH62EK-223M	MM CAP.	0.022 μ F 250V K
C1927	QEH61HM-107MZ	E CAP.	100 μ F 50V M
C1928	QCZ9016-102A	C CAP.	0.001 μ FAC400V K
C1929	QCZ9016-472A	C CAP.	4700pFAC400V M
C1930	QETC1AM-107Z	E CAP.	100 μ F 10V M
C1931	QEHB1EM-477M	E CAP.	470 μ F 25V M
C1932	QETB2CM-106	E CAP.	10 μ F 160V M
C1933	QCZ9016-472A	C CAP.	4700pFAC400V M
C1934	QCZ0115-331A	C CAP.	330pF 2000V K
C1935	QCZ9016-102A	C CAP.	0.001 μ FAC400V K
C1936	QCY32HK-102MZ	C CAP.	1000pF 500V K
C1937	QCS32HJ-221AZ	C CAP.	220pF 500V J
C1940	QCZ9016-472A	C CAP.	4700pFAC400V M
TRANSFORMER			
T1501	CJ39722-00A	H DRIVE TRANSF	
T1502	CJ39721-00A	H DRIVE TRANSF	
T1503	CJ39720-00A	CHOKE TRANSF	
T1505	CE41043-00F	SIDE PIN TRANSF	
T1506	CE41052-00A	SIDE PIN TRANS	
T1901	CE40967-00F	SW. TRANSF.	
COIL			
L1501	CJ39726-A0B	H LIN COIL	
L1502	CELC006-152	CHOKE COIL	
L1503	CELC002-430	CHOKE COIL	
L1901	A76186-2.2Z	PEAKING COIL	2.2 μ H
L1903	CELC003-3R3	CHOKE COIL	
L1905	CELC002-470	CHOKE COIL	
DIODE			
D1401	1SS133-Y	SI. DIODE	
D1402	1SS133-Y	SI. DIODE	
D1403	1SS133-Y	SI. DIODE	
D1404	1SR124-400A-Y	SI. DIODE	
D1405	1SS133-Y	SI. DIODE	
D1406	1SS133-Y	SI. DIODE	
D1407	1SS133-Y	SI. DIODE	
D1409	1SS133-Y	SI. DIODE	
D1410	05A275-R	ZENER DIODE	
D1412	1SS133-Y	SI. DIODE	
D1413	1SS133-Y	SI. DIODE	
D1501	RU3AM-LFB1	SI. DIODE	
D1502	1SS133	SI. DIODE	
D1503	1SS133-Y	SI. DIODE	
D1504	HZ3CLL	ZENER DIODE	
D1505	1SS133-Y	SI. DIODE	
D1506	EG1Z	SI. DIODE	
D1507	1SS131-Y	SI. DIODE	
D1508	HZ6C1	ZENER DIODE	
D1509	MA4075 (M) -Y	ZENER DIODE	

MSV-1219A

SYMBOL NO.	PART NO.	PART NAME	REMARKS
DIODE			
D1510	HZ6C1	ZENER DIODE	
D1511	1SS81-Y	SI. DIODE	
D1512	1SS81-Y	SI. DIODE	
D1513	RD13E (B1)	ZENER DIODE	
D1514	1SS133-Y	SI. DIODE	
D1515	1SS133-Y	SI. DIODE	
D1516	1SS81-R	SI. DIODE	
D1517	RG2A	SI DIODE	
D1518	RU4DS-LFK2	SI. DIODE	
D1519	RG2A	SI DIODE	
D1520	RU4DS-LFK2	SI. DIODE	
D1521	1SS81-Y	SI. DIODE	
D1522	1SS81-Y	SI. DIODE	
D1523	EG1Z	SI. DIODE	
D1524	1SS133-Y	SI. DIODE	
D1525	1SS133-Y	SI. DIODE	
D1526	TVR4N	SI. DIODE	
Δ D1901	TVR4N	SI. DIODE	
Δ D1902	TVR4N	SI. DIODE	
Δ D1903	TVR4N	SI. DIODE	
Δ D1904	TVR4N	SI. DIODE	
D1905	RG2A	SI DIODE	
D1906	EG1Z	SI. DIODE	
D1907	MA4120 (II) -Y	ZENER DIODE	
D1908	EG1Z	SI. DIODE	
D1909	EG1Z	SI. DIODE	
D1910	EG1Z	SI. DIODE	
D1911	RG2A	SI DIODE	
D1912	RG4C-LFK2	SI DIODE	
D1913	RL4Z-LFK2	SI DIODE	
D1914	SF5J42	THYRISTOR	
D1915	MA4068 (L) -Y	ZENER DIODE	
D1916	RL4Z-LFK2	SI DIODE	
D1917	EG1Z	SI. DIODE	
D1918	RD16E (B2) -Y	ZENER DIODE	
D1919	EG1Z	SI. DIODE	
TRANSISTOR			
Q1001	2SA1015 (O, Y) -Y	SI. TRANSISTOR	
Q1003	2SC1959 (Y) -Y	SI. TRANSISTOR	
Q1401	2SC1959 (Y) -Y	SI. TRANSISTOR	
Q1402	2SC1959 (Y) -Y	SI. TRANSISTOR	
Q1403	2SC1162 (C)	SI. TRANSISTOR	
Q1404	2SC1959 (Y) -Y	SI. TRANSISTOR	
Q1501	2SC1959 (Y) -Y	SI. TRANSISTOR	
Q1502	2SC3336	SI. TRANSISTOR	
Q1503	2SC2235 (O, Y)	SI. TRANSISTOR	
Q1504	2SC1959 (Y) -Y	SI. TRANSISTOR	
Q1505	2SC1627A	SI. TRANSISTOR	
Q1506	2SA1015 (O, Y) -Y	SI. TRANSISTOR	
Q1507	2SC1959 (Y) -Y	SI. TRANSISTOR	
Q1508	2SC1627A-Y	SI. TRANSISTOR	
Q1509	2SC1959 (Y) -Y	SI. TRANSISTOR	
Q1510	2SD1409	SI. TRANSISTOR	
Δ Q1511	2SD1959-03	SI TRANSISTOR	H. OUT
Q1512	2SD1409	SI. TRANSISTOR	
Q1513	2SC1685	SI. TRANSISTOR	
Q1514	2SC1959 (Y) -Y	SI. TRANSISTOR	
Q1515	2SC1959 (Y) -Y	SI. TRANSISTOR	

MSV-1219A

SYMBOL NO.	PART NO.	PART NAME	REMARKS
TRANSISTOR			
Q1516	2SC1959 (Y) -Y	SI. TRANSISTOR	
Q1517	2SA1015 (O, Y) -Y	SI. TRANSISTOR	
Q1901	2SC3461 (M)	SI. TRANSISTOR	or 2SC3680
Q1902	2SD1409	SI. TRANSISTOR	
Q1903	2SC1815 (O, Y) -Y	SI. TRANSISTOR	
Q1904	2SC3461 (M)	SI. TRANSISTOR	or 2SC3680
Q1905	2SD1409	SI. TRANSISTOR	
Q1906	2SD866	SI. TRANSISTOR	
IC			
IC1402	AN5515	I. C.	
IC1403	UPC4558C	I. C.	
IC1404	UPC358C	I. C.	
IC1501	M51491SP	I. C.	
IC1502	HA11235	I. C.	
IC1503	AN6558	I. C.	
IC1504	TA78L012AP-Y	I. C.	
IC1505	TA78L012AP-Y	I. C.	
IC1506	TA78L012AP	I. C.	
△ IC1901	SI-8100D	I. C.	
OTHERS			
△ CP1901	MSV-1219AIMSA1	IMSA	
△ CP1902	ICP-N75-Y	IC PROTECTOR	
△ CP1903	ICP-N75-Y	IC PROTECTOR	
△ F1901	QMF51N2-3R0S	FUSE	3.0A
K1901	CE41169-002	PEAKING COIL	
K1902	CE41169-002	PEAKING COIL	
K1903	CE41169-002	PEAKING COIL	
K1904	CE41169-002	PEAKING COIL	
K1905	CE41169-003	PEAKING COIL	
K1906	CE41169-002	PEAKING COIL	
△ K1907	CE41169-002	PEAKING COIL	
△ K1908	CE41169-003	PEAKING COIL	
△ LF1901	CE41232-00B	LINE FILTER	
△ RY1501	CESK003-001	RELAY	
SW1401	QSL4A13-C02	LEVER SWITCH	Service
S1501	QSL4A13-C02	LEVER SWITCH	H Center
S1502	QSL4A13-C02	LEVER SWITCH	H Center
S1503	QSL4A13-C02	LEVER SWITCH	H Center
△ TH1901	A76038	W POSISTOR	or A76038-T

CRT SOCKET P.C.B. (MSV-3000A)

SYMBOL NO.	PART NO.	PART NAME	REMARKS
VARIABLE RESISTOR			
R3102	QVPE607-103M	V R (R DRIVE)	10 k Ω B
R3104	QVPE607-103M	V R (R CUT OFF)	10 k Ω B
R3202	QVPE607-103M	V R (G DRIVE)	10 k Ω B
R3204	QVPE607-103M	V R (G CUT OFF)	10 k Ω B
R3302	QVPE607-103M	V R (B DRIVE)	10 k Ω B
R3304	QVPE607-103M	V R (B CUT OFF)	10 k Ω B
RESISTOR			
R3001	QRD161J-182Y	C R	1.8 k Ω 1/6W J
R3002	QRD161J-102Y	C R	1 k Ω 1/6W J
R3003	QRD161J-472Y	C R	4.7 k Ω 1/6W J
R3004	QRD161J-102Y	C R	1 k Ω 1/6W J
R3005	QRD123J-820SX	C R	82 Ω 1/2W J
R3103	QRD161J-183Y	C R	18 k Ω 1/6W J
R3105	QRD161J-101Y	C R	100 Ω 1/6W J
R3106	QRD161J-561Y	C R	560 Ω 1/6W J
R3107	QRD143J-101SX	C R	100 Ω 1/4W J
R3108	QRD161J-151Y	C R	150 Ω 1/6W J
R3109	QRD123J-121SX	C R	120 Ω 1/2W J
R3110	QRD161J-820Y	C R	82 Ω 1/6W J
R3111	QRD161J-122Y	C R	1.2 k Ω 1/6W J
R3112	QRG029J-561A	OM R	560 Ω 2W J
R3113	QRZ0069-122	UNF R	1.2 k Ω 5W K
R3114	QRD161J-471Y	C R	470 Ω 1/6W J
R3115	QRD161J-562Y	C R	5.6 k Ω 1/6W J
R3116	QRD161J-153Y	C R	15 k Ω 1/6W J
R3117	QRD161J-272Y	C R	2.7 k Ω 1/6W J
R3118	QRD161J-470Y	C R	47 Ω 1/6W J
R3181	QRC122K-271	COMP. R	270 Ω 1/2W K
R3203	QRD161J-183Y	C R	18 k Ω 1/6W J
R3205	QRD161J-101Y	C R	100 Ω 1/6W J
R3206	QRD161J-561Y	C R	560 Ω 1/6W J
R3207	QRD143J-101SX	C R	100 Ω 1/4W J
R3208	QRD161J-151Y	C R	150 Ω 1/6W J
R3209	QRD123J-121SX	C R	120 Ω 1/2W J
R3210	QRD161J-470Y	C R	47 Ω 1/6W J
R3211	QRD161J-122Y	C R	1.2 k Ω 1/6W J
R3212	QRG029J-561A	OM R	560 Ω 2W J
R3213	QRZ0069-122	UNF R	1.2 k Ω 5W K
R3214	QRD161J-471Y	C R	470 Ω 1/6W J
R3215	QRD161J-562Y	C R	5.6 k Ω 1/6W J
R3216	QRD161J-153Y	C R	15 k Ω 1/6W J
R3217	QRD161J-272Y	C R	2.7 k Ω 1/6W J
R3218	QRD161J-820Y	C R	82 Ω 1/6W J
R3281	QRC122K-271	COMP. R	270 Ω 1/2W K
R3303	QRD161J-183Y	C R	18 k Ω 1/6W J
R3305	QRD161J-101Y	C R	100 Ω 1/6W J
R3306	QRD161J-561Y	C R	560 Ω 1/6W J
R3307	QRD143J-101SX	C R	100 Ω 1/4W J
R3308	QRD161J-151Y	C R	150 Ω 1/6W J
R3309	QRD123J-121SX	C R	120 Ω 1/2W J
R3310	QRD161J-470Y	C R	47 Ω 1/6W J
R3311	QRD161J-122Y	C R	1.2 k Ω 1/6W J
R3312	QRG029J-561A	OM R	560 Ω 2W J
R3313	QRZ0069-122	UNF R	1.2 k Ω 5W K
R3314	QRD161J-471Y	C R	470 Ω 1/6W J
R3315	QRD161J-562Y	C R	5.6 k Ω 1/6W J
R3316	QRD161J-153Y	C R	15 k Ω 1/6W J
R3317	QRD161J-272Y	C R	2.7 k Ω 1/6W J

MSV-3000A

SYMBOL NO.	PART NO.	PART NAME	REMARKS
RESISTOR			
R3318	QRD161J-820Y	C R	82 Ω 1/6W J
R3381	QRC122K-271	COMP. R	270 Ω 1/2W K
R3501	QRG019J-822S	OM R	8.2k Ω 1W J
R3502	QRD161J-104Y	C R	100k Ω 1/6W J
R3503	QRD161J-102Y	C R	1k Ω 1/6W J
R3581	QRC122K-471	COMP. R	470 Ω 1/2W K
CAPACITOR			
C3001	QEHC1EM-107MZ	E CAP.	100 μ F 25V M
C3002	QCY31HK-103AZ	C CAP.	0.01 μ F 50V K
C3003	QCY31HK-222MZ	C CAP.	2200pF 50V K
C3004	QEHC1EM-107MZ	E CAP.	100 μ F 25V M
C3081	QEHC1EM-107MZ	E CAP.	100 μ F 25V M
C3101	QEN51HM-105	BP E CAP.	1 μ F 50V M
C3102	QFV41HJ-104M	TF CAP.	0.1 μ F 50V J
C3103	QCY31HK-102AZ	C CAP.	1000pF 50V K
C3105	QFM71HK-223MZ	M CAP.	0.022 μ F 50V K
C3106	QFM71HK-473MZ	M CAP.	0.047 μ F 50V K
C3107	QCS31HJ-181MZ	C CAP.	180pF 50V J
C3108	QCS31HJ-680AZ	C CAP.	68pF 50V J
C3109	QFV81HJ-104M	TF CAP.	0.1 μ F 50V J
C3201	QEN51HM-105	BP E CAP.	1 μ F 50V M
C3202	QFV41HJ-104M	TF CAP.	0.1 μ F 50V J
C3203	QCY31HK-102AZ	C CAP.	1000pF 50V K
C3205	QFM71HK-223MZ	M CAP.	0.022 μ F 50V K
C3206	QFM71HK-473M	M CAP.	0.047 μ F 50V K
C3207	QCS31HJ-680AZ	C CAP.	68pF 50V J
C3208	QCS31HJ-181AZ	C CAP.	180pF 50V J
C3209	QCY31HK-222MZ	C CAP.	2200pF 50V K
C3301	QEN61HM-105Z	BP E CAP.	1 μ F 50V M
C3302	QFV41HJ-104M	TF CAP.	0.1 μ F 50V J
C3303	QCY31HK-102AZ	C CAP.	1000pF 50V K
C3305	QFM71HK-223M	M CAP.	0.022 μ F 50V K
C3306	QFM71HK-473MZ	M CAP.	0.047 μ F 50V K
C3307	QCS31HJ-680AZ	C CAP.	68pF 50V J
C3308	QCS31HJ-181AZ	C CAP.	180pF 50V J
C3309	QCY31HK-222MZ	C CAP.	2200pF 50V K
C3501	QFM72DK-563M	M CAP.	0.056 μ F 200V K
C3504	QEH52CM-336M	E CAP.	33 μ F 160V M
C3505	QEH52CM-105M	E CAP.	1 μ F 160V M
C3581	QCZ9016-103A	C CAP.	0.01 μ FAC400V P
COIL			
L3001	A04725-150Z	PEAKING COIL	150 μ H
L3101	A76186-2.7Z	PEAKING COIL	2.7 μ H
L3102	A76186-5.6Z	PEAKING COIL	5.6 μ H
L3201	A76186-2.7Z	PEAKING COIL	2.7 μ H
L3202	A76186-5.6Z	PEAKING COIL	5.6 μ H
L3301	A76186-2.7Z	PEAKING COIL	2.7 μ H
L3302	A76186-5.6Z	PEAKING COIL	5.6 μ H
L3501	A76186-1000Z	PEAKING COIL	1MH
DIODE			
D3101	RD20E (B)	ZENER DIODE	
D3201	RD20E (B)	ZENER DIODE	
D3301	RD20E (B)	ZENER DIODE	
D3501	1SR124-400-HJ	SI. DIODE	
D3502	1SR124-400-HJ	SI. DIODE	
D3503	1SS81	SI. DIODE	

MSV-3000A

SYMBOL NO.	PART NO.	PART NAME	REMARKS
TRANSISTOR			
Q3101	2SC1906	SI. TRANSISTOR	
Q3102	2SC3946	SI. TRANSISTOR	
Q3103	2SC1360	SI. TRANSISTOR	
Q3201	2SC1906	SI. TRANSISTOR	
Q3202	2SC3946	SI. TRANSISTOR	
Q3203	2SC1360	SI. TRANSISTOR	
Q3301	2SC1906	SI. TRANSISTOR	
Q3302	2SC3946	SI. TRANSISTOR	
Q3303	2SC1360	SI. TRANSISTOR	
Q3501	2SC1890A (E, F)	SI. TRANSISTOR	
IC			
IC3001	M51493P	I. C.	
IC3002	TA78L012AP	I. C.	
OTHERS			
Δ	A75522-C	CRT SOCKET	

CONTROL P.C.B. (MSV-4001A)

SYMBOL NO	PART NO.	PART NAME	REMARKS
VARIABLE RESISTOR			
R4001	QVPE604-203H	V R (V. SIZE)	20k Ω B
R4002	QVPE604-203H	V R (V. SIZE)	20k Ω B
R4003	QVPE604-203H	V R (V. SIZE)	20k Ω B
R4004	QVPE604-203H	V R (V. SIZE)	20k Ω B
R4005	QVPE604-203H	V R (V. POS1)	20k Ω B
R4006	QVPE604-203H	V R (V. POS1)	20k Ω B
R4007	QVPE604-203H	V R (V. POS1)	20k Ω B
R4008	QVPE604-203H	V R (V. POS1)	20k Ω B
R4009	QVPE604-203H	V R (H. SIZE)	20k Ω B
R4010	QVPE604-203H	V R (H. SIZE)	20k Ω B
R4011	QVPE604-203H	V R (H. SIZE)	20k Ω B
R4012	QVPE604-203H	V R (H. SIZE)	20k Ω B
R4013	QVPE604-203H	V R (H. POS1)	20k Ω B
R4014	QVPE604-203H	V R (H. POS1)	20k Ω B
R4015	QVPE604-203H	V R (H. POS1)	20k Ω B
R4016	QVPE604-203H	V R (H. POS1)	20k Ω B
R4018	QVPE604-203H	V R (WINDOW)	20k Ω B
R4020	QVPE604-203H	V R (WINDOW)	20k Ω B
R4024	QVPE604-203H	V R (WINDOW)	20k Ω B
RESISTOR			
R4017	QRD161J-563Y	C R	56k Ω 1/6W J
R4019	QRD161J-103Y	C R	10k Ω 1/6W J
R4021	QRD161J-563Y	C R	56k Ω 1/6W J
R4022	QRD161J-103Y	C R	10k Ω 1/6W J
R4023	QRD161J-563Y	C R	56k Ω 1/6W J
R4025	QRD161J-223Y	C R	22k Ω 1/6W J
R4026	QRD161J-123Y	C R	12k Ω 1/6W J
R4027	QRD161J-124Y	C R	120k Ω 1/6W J
R4028	QRD161J-333Y	C R	33k Ω 1/6W J
R4029	QRD161J-151Y	C R	150 Ω 1/6W J
R4030	QRD161J-104Y	C R	100k Ω 1/6W J
R4031	QRD161J-102Y	C R	1k Ω 1/6W J
R4032	QRD161J-102Y	C R	1k Ω 1/6W J
R4033	QRD161J-102Y	C R	1k Ω 1/6W J
R4034	QRD161J-124Y	C R	120k Ω 1/6W J
R4035	QRD161J-102Y	C R	1k Ω 1/6W J
R4036	QRD161J-104Y	C R	100k Ω 1/6W J
R4037	QRD161J-103Y	C R	10k Ω 1/6W J
R4038	QRD161J-223Y	C R	22k Ω 1/6W J
R4039	QRD161J-333Y	C R	33k Ω 1/6W J
R4040	QRD161J-103Y	C R	10k Ω 1/6W J
R4041	QRD161J-183Y	C R	18k Ω 1/6W J
R4042	QRD161J-103Y	C R	10k Ω 1/6W J
R4043	QRD161J-333Y	C R	33k Ω 1/6W J
R4044	QRD161J-103Y	C R	10k Ω 1/6W J
DIODE			
D4001	1SS133-Y	SI. DIODE	
D4002	RD5. 6ES (B2) -Y	ZENER DIODE	
D4003	1SS133-Y	SI. DIODE	
D4004	1SS133-Y	SI. DIODE	
D4005	1SS133-Y	SI. DIODE	
D4006	RD4. 3ES (B2) -Y	ZENER DIODE	
TRANSISTOR			
Q4001	2SD637 (R, S)	SI. TRANSISTOR	
IC			
IC4001	TC4052BP	I. C.	
IC4002	TC4052BP	I. C.	

MSV-4001A

SYMBOL NO.	PART NO.	PART NAME	REMARKS
IC			
IC4003	UPC4558	I. C.	
IC4004	UPC4558	I. C.	
OTHERS			
SW4001	QSP2C22-C01	PUSH SWITCH	Over Scan
SW4002	QSP2C22-C01	PUSH SWITCH	Preset Cancel
SW4003	QSP2C22-C01	PUSH SWITCH	Colors

INPUT P.C.B. (MSV-4103A)

SYMBOL NO.	PART NO.	PART NAME	REMARKS
VARIABLE RESISTOR			
R4081	QVAA024-CB53A	V R (CONTRAST)	
R4086	QVAA021-CB53A	V R (BRIGHT)	
RESISTOR			
R4080	QRD162J-152	C R	1.5k Ω 1/6W J
R4083	QRD162J-471	C R	470 Ω 1/6W J
R4084	QRD162J-122	C R	1.2k Ω 1/6W J
R4087	QRD162J-471	C R	470 Ω 1/6W J
DIODE			
D4080	GL-5PG23	L E D	Power
D4084	1SS133	SI. DIODE	
D4082	RD6.2ES (82)	ZENER DIODE	
TRANSISTOR			
Q4080	2SA1015 (O. Y) -L	SI. TRANSISTOR	

INPUT P.C.B. (MSV-6000A)

SYMBOL NO.	PART NO.	PART NAME	REMARKS
VARIABLE RESISTOR			
R6109	QVPE806-102H	V R (R. LEVEL ADJ)	1 k Ω B
R6309	QVPE806-102H	V R (B. LEVEL ADJ)	1 k Ω B
RESISTOR			
R6001	QRD161J-222Y	C R	2.2 k Ω 1/6W J
R6002	QRD161J-222Y	C R	2.2 k Ω 1/6W J
R6003	QRD161J-123Y	C R	12 k Ω 1/6W J
R6005	QRD161J-331Y	C R	330 Ω 1/6W J
R6006	QRD161J-331Y	C R	330 Ω 1/6W J
R6007	QRD161J-331Y	C R	330 Ω 1/6W J
R6008	QRD161J-681Y	C R	680 Ω 1/6W J
R6009	QRD161J-681Y	C R	680 Ω 1/6W J
R6010	QRD161J-681Y	C R	680 Ω 1/6W J
R6012	QRD161J-821Y	C R	820 Ω 1/6W J
R6021	QRD161J-562Y	C R	5.6 k Ω 1/6W J
R6022	QRD161J-562Y	C R	5.6 k Ω 1/6W J
R6023	QRD161J-103Y	C R	10 k Ω 1/6W J
R6024	QRD161J-562Y	C R	5.6 k Ω 1/6W J
R6027	QRD161J-823Y	C R	82 k Ω 1/6W J
R6028	QRD161J-221Y	C R	220 Ω 1/6W J
R6029	QRD161J-332Y	C R	3.3 k Ω 1/6W J
R6030	QRD161J-682Y	C R	6.8 k Ω 1/6W J
R6031	QRD161J-103Y	C R	10 k Ω 1/6W J
R6032	QRD161J-102Y	C R	1 k Ω 1/6W J
R6033	QRD161J-473Y	C R	47 k Ω 1/6W J
R6101	QRD161J-123	C R	12 k Ω 1/6W J
R6102	QRV141F-75R0AY	MF R	75 Ω 1/4W F
R6103	QRD161J-331Y	C R	330 Ω 1/6W J
R6104	QRD161J-221Y	C R	220 Ω 1/6W J
R6105	QRD161J-331Y	C R	330 Ω 1/6W J
R6106	QRD161J-221Y	C R	220 Ω 1/6W J
R6107	QRD161J-182Y	C R	1.8 k Ω 1/6W J
R6108	QRD161J-332Y	C R	3.3 k Ω 1/6W J
R6110	QRD161J-681Y	C R	680 Ω 1/6W J
R6111	QRD161J-394Y	C R	390 k Ω 1/6W J
R6112	QRD161J-333Y	C R	33 k Ω 1/6W J
R6113	QRD161J-331Y	C R	330 Ω 1/6W J
R6114	QRD161J-104Y	C R	100 k Ω 1/6W J
R6115	QRD161J-332Y	C R	3.3 k Ω 1/6W J
R6116	QRD161J-472Y	C R	4.7 k Ω 1/6W J
R6118	QRD161J-680Y	C R	68 Ω 1/6W J
R6201	QRD161J-123	C R	12 k Ω 1/6W J
R6202	QRV141F-75R0AY	MF R	75 Ω 1/4W F
R6203	QRD161J-331Y	C R	330 Ω 1/6W J
R6204	QRD161J-221Y	C R	220 Ω 1/6W J
R6205	QRD161J-331Y	C R	330 Ω 1/6W J
R6206	QRD161J-221Y	C R	220 Ω 1/6W J
R6207	QRD161J-102Y	C R	1 k Ω 1/6W J
R6208	QRD161J-271Y	C R	270 Ω 1/6W J
R6209	QRD141J-821SY	C R	820 Ω 1/4W J
R6210	QRD161J-332Y	C R	3.3 k Ω 1/6W J
R6211	QRD161J-331Y	C R	330 Ω 1/6W J
R6212	QRD161J-394Y	C R	390 k Ω 1/6W J
R6213	QRD161J-333Y	C R	33 k Ω 1/6W J
R6215	QRD161J-104Y	C R	100 k Ω 1/6W J
R6216	QRD161J-332Y	C R	3.3 k Ω 1/6W J
R6218	QRD161J-680Y	C R	68 Ω 1/6W J
R6301	QRD161J-123	C R	12 k Ω 1/6W J
R6302	QRV141F-75R0AY	MF R	75 Ω 1/4W F

MSV-6000A

SYMBOL NO.	PART NO.	PART NAME	REMARKS
RESISTOR			
R6303	QRD161J-331Y	C R	330 Ω 1/6W J
R6304	QRD161J-221Y	C R	220 Ω 1/6W J
R6305	QRD161J-331Y	C R	330 Ω 1/6W J
R6306	QRD141J-221SY	C R	220 Ω 1/4W J
R6307	QRD161J-182Y	C R	1.8k Ω 1/6W J
R6308	QRD161J-332Y	C R	3.3k Ω 1/6W J
R6310	QRD161J-681Y	C R	680 Ω 1/6W J
R6311	QRD161J-394Y	C R	390k Ω 1/6W J
R6312	QRD161J-333Y	C R	33k Ω 1/6W J
R6313	QRD161J-331Y	C R	330 Ω 1/6W J
R6314	QRD161J-104Y	C R	100k Ω 1/6W J
R6315	QRD161J-332Y	C R	3.3k Ω 1/6W J
R6316	QRD161J-472Y	C R	4.7k Ω 1/6W J
R6318	QRD161J-680Y	C R	68 Ω 1/6W J
R6410	QRD161J-223Y	C R	22k Ω 1/6W J
R6411	QRD161J-223Y	C R	22k Ω 1/6W J
R6412	QRD161J-474Y	C R	470k Ω 1/6W J
R6413	QRD161J-223Y	C R	22k Ω 1/6W J
R6466	QRD161J-103Y	C R	10k Ω 1/6W J
R6474	QRD161J-334Y	C R	330k Ω 1/6W J
R6476	QRD161J-102Y	C R	1k Ω 1/6W J
CAPACITOR			
C6001	QETC1CM-106Z	E CAP.	10 μ F 16V M
C6003	QETC1HM-475Z	E CAP.	4.7 μ F 50V M
C6005	QETC1CM-227Z	E CAP.	220 μ F 16V M
C6006	QETC1AM-476Z	E CAP.	47 μ F 10V M
C6007	QFV41HJ-104M	TF CAP.	0.1 μ F 50V J
C6008	QFV41HJ-104M	TF CAP.	0.1 μ F 50V J
C6009	QFV41HJ-104M	TF CAP.	0.1 μ F 50V J
C6010	QETC1EM-336Z	E CAP.	33 μ F 25V M
C6011	QFV41HJ-104M	TF CAP.	0.1 μ F 50V J
C6012	QETB1CM-476	E CAP.	47 μ F 16V M
C6101	QEN61HM-475Z	BP E CAP.	4.7 μ F 50V M
C6201	QEN61HM-475Z	BP E CAP.	4.7 μ F 50V M
C6301	QEN61HM-475Z	BP E CAP.	4.7 μ F 50V M
C6401	QEN61HM-105Z	BP E CAP.	1 μ F 50V M
C6402	QETC1HM-105Z	E CAP.	1 μ F 50V M
C6403	QFV71HJ-474MZ	TF CAP.	0.47 μ F 50V J
C6404	QEN61HM-335Z	BP E CAP.	3.3 μ F 50V M
C6405	QFV71HJ-224MZ	TF CAP.	0.22 μ F 50V J
C6406	QETC1CM-106Z	E CAP.	10 μ F 16V M
C6407	QETC1CM-106Z	E CAP.	10 μ F 16V M
C6430	QFM71HJ-152MZ	M CAP.	1500pF 50V J
C6434	QETC1HM-105Z	E CAP.	1 μ F 50V M
C6438	QETA1CM-477	E CAP.	470 μ F 16V M
COIL			
L6401	A76186-1000Z	PEAKING COIL	1MH
DIODE			
D6001	RD9. 1JS (B3) -Y	ZENER DIODE	
D6002	RD9. 1JS (B3) -Y	ZENER DIODE	
D6003	RD9. 1JS (B3) -Y	ZENER DIODE	
D6004	RD9. 1JS (B3) -Y	ZENER DIODE	
D6005	RD9. 1JS (B3) -Y	ZENER DIODE	
D6006	RD9. 1JS (B3) -Y	ZENER DIODE	
D6007	RD9. 1JS (B3) -Y	ZENER DIODE	
D6008	RD9. 1JS (B3) -Y	ZENER DIODE	
D6009	RD9. 1JS (B3) -Y	ZENER DIODE	
D6010	1SS133-Y	SI. DIODE	

MSV-6000A

SYMBOL NO.	PART NO.	PART NAME	REMARKS
DIODE			
D6011	1SS133-Y	SI. DIODE	
D6102	1SS133	SI. DIODE	
D6201	1SS133-Y	SI. DIODE	
D6202	1SS133	SI. DIODE	
D6302	1SS133	SI. DIODE	
D6401	MAA062 (M) -Y	ZENER DIODE	
TRANSISTOR			
Q6001	2SC1959 (Y) -Y	SI. TRANSISTOR	
Q6005	2SC1959 (Y) -Y	SI. TRANSISTOR	
Q6006	2SC1959 (Y) -Y	SI. TRANSISTOR	
Q6007	2SC1959 (Y) -Y	SI. TRANSISTOR	
Q6008	2SC1959 (Y) -Y	SI. TRANSISTOR	
Q6101	2SA1015 (O. Y) -Y	SI. TRANSISTOR	
Q6201	2SA1015 (O. Y) -Y	SI. TRANSISTOR	
Q6301	2SA1015 (O. Y) -Y	SI. TRANSISTOR	
IC			
IC6001	SN74LS367AN	I. C. (M)	
IC6002	TC4066BP	I. C.	
IC6003	SN74LS138N	I. C. (M)	
IC6004	SN74LS367AN	I. C. (M)	
IC6005	TC4053BP	I. C.	
IC6006	TC4053BP	I. C.	
IC6007	TA78L012AP	I. C.	
IC6401	M51492L	I. C.	
OTHERS			
J01	CE41348-009SL	D SUB 9S	
SW6001	QST1101-C04	PUSH SWITCH	TTL/Analog Input
SW6002	QST1101-C03	PUSH SWITCH	Color/Mono

PACKING DIAGRAM

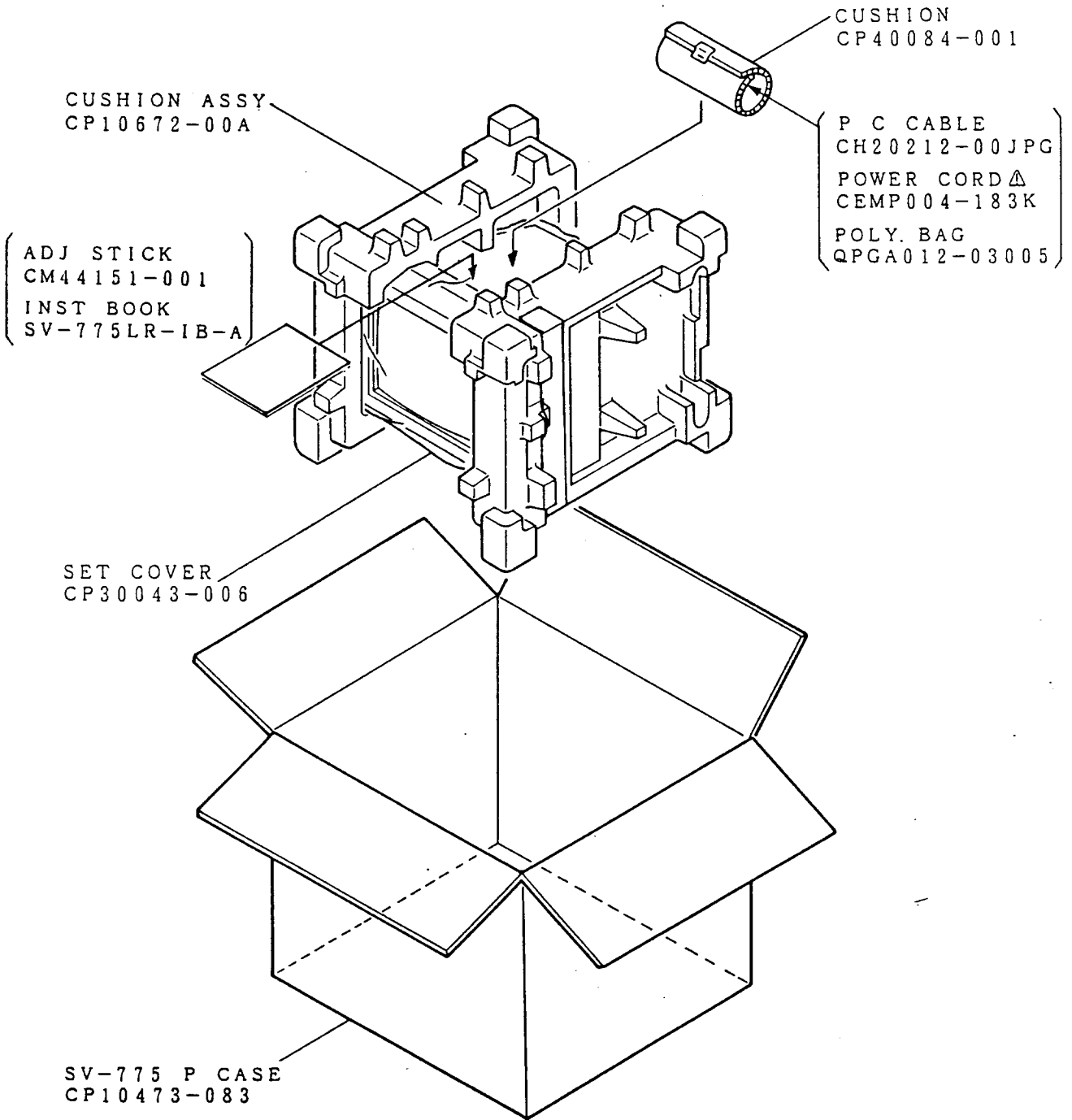

SCHEMATIC DIAGRAM MODEL SV-775LR

■ SAFETY PRECAUTIONS

- The FR (FR) is a fusible resistor, thus possessing the function of a fuse. When replacing their fusible resistor or the safety-indicated parts (\triangle) shown in the circuit diagrams, be sure to use correctly designated parts for safety.

Also, to ensure safety and maintenance of designated performance, also use the specified items on other components.

■ INDICATED VOLTAGE AND WAVEFORMS

- Voltage/waveforms on respective components are indicated by actually measuring them with a tester or an oscilloscope through receiving service color bar signals of sufficient sensitivity. The volume positions are set as a result of measurement under the condition of factory shipment. Since the signal systems present slightly fluctuating values depending on adjustment and other conditions, the indicated values should be used as reference values. All indicated values represent DC voltage.

Tester used for measuring

Internal resistance DC 20 k Ω /V

Oscilloscope sweeping time

H \rightarrow 20 μ S/div

V \rightarrow 5 mS/div

Others \rightarrow Sweeping time is indicated

■ CIRCUIT DIAGRAM DISPLAY SYMBOLS

1. Resistor

- Resistance value
 - When no unit is provided: [Ω]
 - K: [k Ω]
 - M: [M Ω]
- Type
 - Without indication : Carbon resistor
 - OMR : Oxide metal film resistor
 - UNF : Inflammable resistor
 - CMF, MFR : Coating metal film resistor
 - FR : Fusible resistor
- * Composition resistor 1/2 [W] is indicated as 1/2S or Comp.
- Rated permissible power capacity
 - When no display is made: 1/6 [W]
 - Others: Display are provided
 - * Composition resistor 1/2 [W] is displayed as "1/2S" or "comp."

2. Capacitor

- Capacity
 - Over 1 [pF] Below 1 [μ F]
- Withstand voltage
 - No display : DC 50 [V]
 - Others : DC withstand voltage [V]
 - AC display : AC withstand voltage [V]
- Display of electrolytic capacitor is as follows. (Example)
 - 47/50 \rightarrow Capacity [μ F]/withstand voltage [V]
 - * NP : Non-polar (or Bipolar) electrolytic cap..
- Type
 - No type display : Ceramic capacitor indication
 - MY : Mylar capacitor
 - MM : Metalized mylar capacitor
 - PP : Polypropylene capacitor
 - MPP : Metalized polypropylene capacitor
 - NP : Nonpolar electrolytic capacitor
 - BP : Bipolar electrolytic capacitor
 - TAN. : Tantalum capacitor

3. Coil

When no unit is displayed: [μ H]

4. Power supply

 : 126 V

 : 25 V

 : 15 V

 : 12 V

* Respective voltage values are indicated.

5. Test point & GND. symbol

 : Test point of mini-GP pin

 : Only test point display

 : LIVE side ground

 : NEUTRAL side ground

 : EARTH ground

6. Connecting method

 : Connector

 : Wrapping or soldering

 : Receptacle

* Since the reference circuits are provided, the circuits configuration and/or constants are subject to change without prior notice to achieve further improvements.

■ BASINGS OF TRANSISTORS & ICs



2SA564
2SC1627A
2SC1685(R)
2SC1815(Y, GR)
2SA844
2SA1015(Q, Y)
2SC1472
2SC1845
2SC1890A
2SC1906
2SC1959(Y)
2SC1740(Q, R)



2SD789(B)
2SC2235
2SC1360
2SC1973
2SC2229
2SC2482V
2SB1013(O)
2SA966
2SC2655(Y)
2SC2230A



2SD975
2SD781
2SC1162(C)
2SC3595
2SC3599
2SC2371(K-M)



2SK68A
2SK301



2SC3425
2SC3613
2SD1433



2SD1263A
2SD1274A
2SD1264A
2SD1409
2SC3946



2SD982



2SC2612
2SD1128-06
2SD1138(C, D)
2SD866B
2SD866A



2SD1428V1
2SC3336
2SD921/2SC3449(M)
2SC2555
2SC2792
2SC3461(L, M)

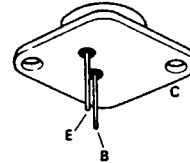

2SC3412



2SB641(Q, R)
2SB642
2SC2647-C
2SC637(Q, R)



H11AV1A

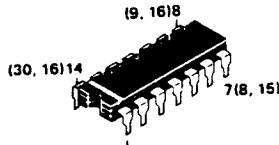

IC
AN78L05



IC
TA78L005AP
TA78L012AP

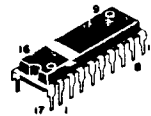

IC
HA11423
HA11235

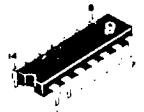

TC4053BP
TC4066BP
SN74LS367AN
SN74LS138N



μPC358C
μPC4556C
μPC4558C

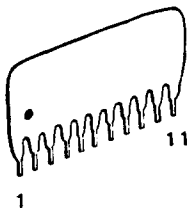

SI-9503
SI-8100D

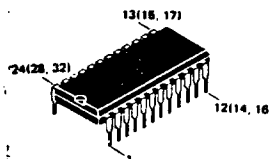

IC
M51309SP
M58659FP
M50435-893FP
AN5635NS
M51493P
M51491SP

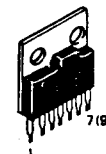

IC
AN7168
AN5265
LA7830
AN5515



CTU-G3DR

■ PARTS LIST (Δ parts in the schematic diagram)

SYMBOL NO.	Δ	PART NO.	PART NAME	REMARKS
	Δ	CJ39691-00A	DEG. COIL	L01
	Δ	QSE4A21-C08	SEESAW SWITCH	SW01 Power
	Δ	CJ26903-00B	DEFLECTION YOKE	DY01
	Δ	CE40811-00Q	NOISE FILTER	NF01
	Δ	CJ26891-00D	F B T	T1504
	Δ	AT1469SHB22EITC	ITC TUBE	Include Def York, PC Magnet, Wedge Ass'y
RESISTOR				
R1540	Δ	QRV141F-5901Y	MF R	5.9k Ω 1/4W F
R1541	Δ	QRV141F-6802Y	MF R	68k Ω 1/4W F
R1918	Δ	QRV141F-2702AY	MF R	27k Ω 1/4W F
R1924	Δ	QRV141F-5601AY	MF R	5.6k Ω 1/4W F
CAPACITOR				
C1542	Δ	QFZ0081-3101S	PP CAP.	3100pF 1600V \pm 3%
C1544	Δ	QFZ0081-3601S	MPP CA.	3600pF 1600V \pm 3%
C1545	Δ	QFZ0081-3701S	MPP CAP.	3700pF 1600V \pm 3%
C1546	Δ	QFZ0081-3501S	PP CAP.	3500pF 1600V \pm 3%
C1901	Δ	QFZ9022-224M	MF CAP.	0.22 μ FAC250V M
C1904	Δ	QFZ9022-104M	MF CAP.	0.1 μ FAC250V M
C1905	Δ	QFZ9022-224M	MF CAP.	0.22 μ FAC250V M
C1906	Δ	QCZ9033-103A	C CAP.	0.01 μ FAC400V P
C1907	Δ	QCZ9033-103A	C CAP.	0.01 μ FAC400V P
C1929	Δ	QCZ9016-472A	C CAP.	4700pFAC400V M
C1933	Δ	QCZ9016-472A	C CAP.	4700pFAC400V M
C1934	Δ	QCZ0115-331A	C CAP.	330pF 2000V K
C1940	Δ	QCZ9016-472A	C CAP.	4700pFAC400V M
TRANSFORMER				
T1505	Δ	CE41043-00F	SIDE PIN TRANSF	
T1506	Δ	CE41052-00A	SIDE PIN TRANS	
T1901	Δ	CE40967-00F	SW. TRANSF.	
COIL				
L1501	Δ	CJ39726-A0B	H LIN COIL	
DIODE				
D1508	Δ	HZ6C1	ZENER DIODE	
D1901	Δ	TVR4N	SI. DIODE	
D1902	Δ	TVR4N	SI. DIODE	
D1903	Δ	TVR4N	SI. DIODE	
D1904	Δ	TVR4N	SI. DIODE	
TRANSISTOR				
Q1511	Δ	2SD1959-03	SI TRANSISTOR	H. OUT
IC				
IC1901	Δ	SI-8100D	I. C.	
OTHERS				
	Δ	CEMP004-183K	POWER CORD	
	Δ	A75522-C	CRT SOCKET	
CP1901	Δ	ICP-N75-Y	IC PROTECTOR	
CP1902	Δ	ICP-N75-Y	IC PROTECTOR	
CP1903	Δ	ICP-N75-Y	IC PROTECTOR	
F1901	Δ	QMF51N2-3R0S	FUSE	3.0A
K1907	Δ	CE41169-002	PEAKING COIL	
K1908	Δ	CE41169-003	PEAKING COIL	
LF1901	Δ	CE41232-00B	LINE FILTER	
RY1501	Δ	CESK003-001	RELAY	
TH1901	Δ	A76038	W POSISTOR	or A76038-T

SV-775LR FRONT CONTROL PCB ASSY
 MSV-4103A CK40295-F01-6

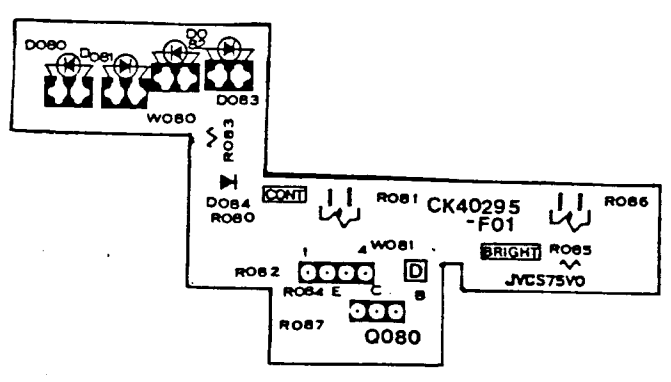
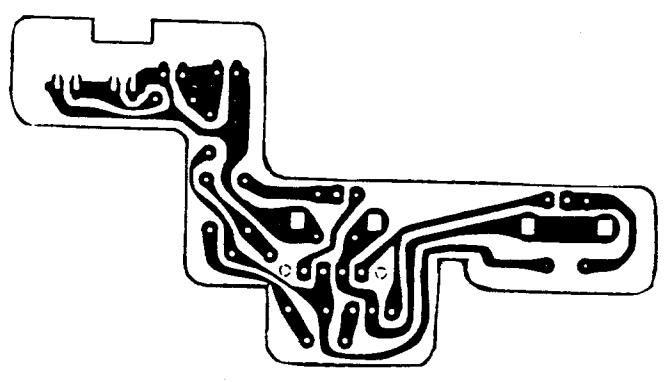
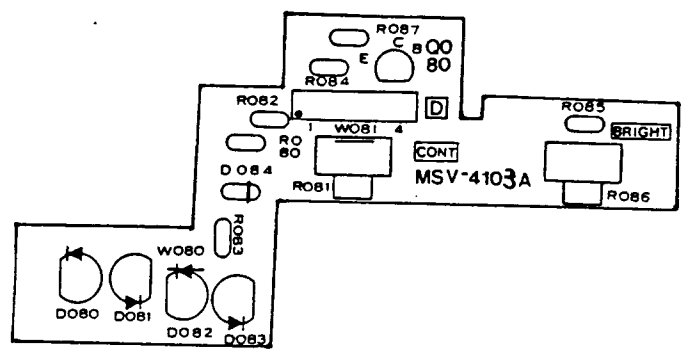

SV-775LR CONTROL PCB ASSY
 MSV-4001A CK30701-D01-3

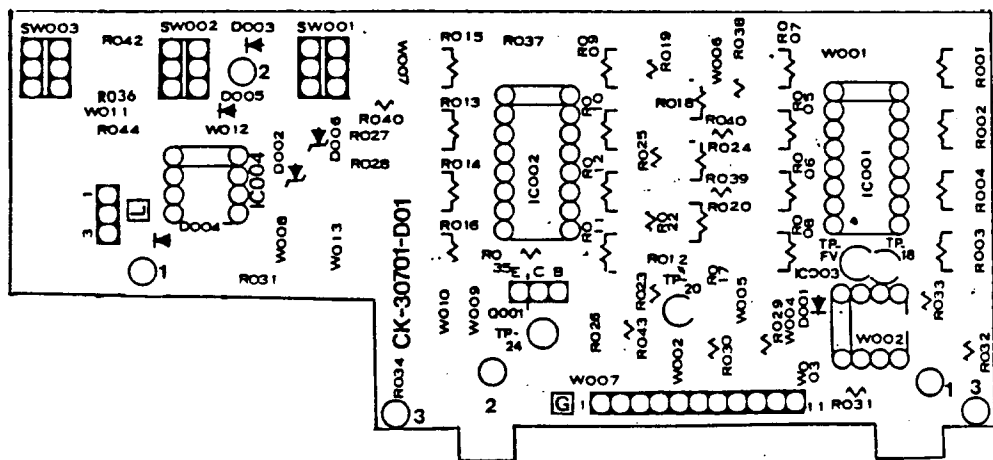
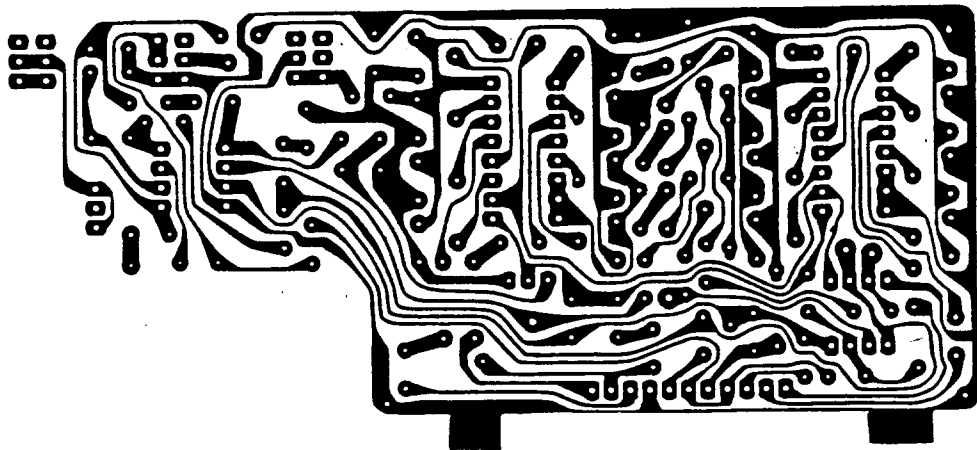
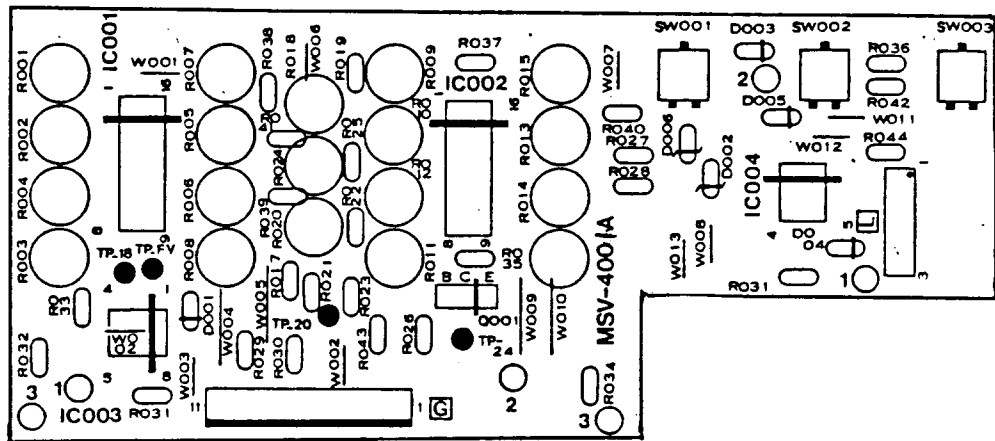



Document
Control

Document Title: Supervision 770+ Service Manual	
Issue Number: 002 Revision 2	
Issued By: Dick Menhinick	Date of Issue: 14/3/90
Revisions: 1). Document Control added 30/11/88 2). Monitor adjustment guide added 30/11/88 3). Safety Notices Added 30/11/88 4). Addition of Section covering Supervision 770+ LR (Low Radiation Model)	

MSV-3000A (CRT PS SOCKET ASSY)
 CK10526-1D01

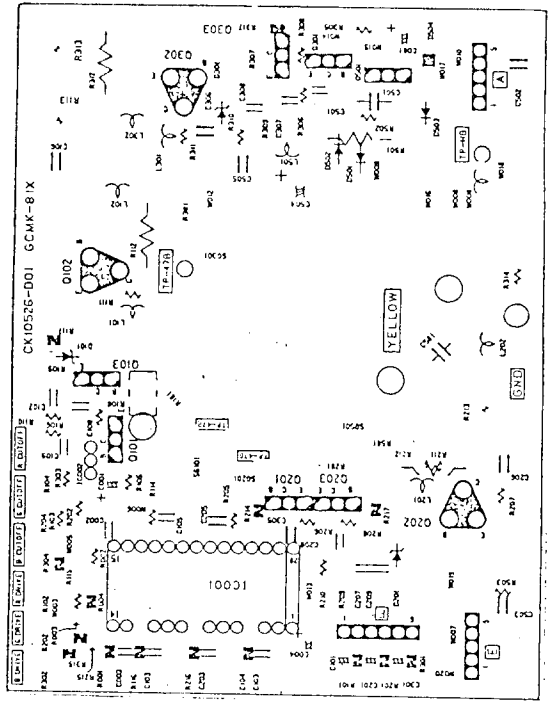
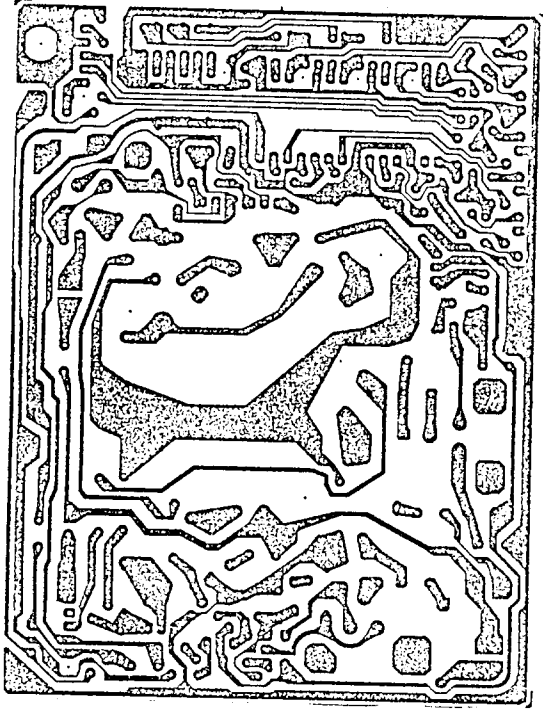
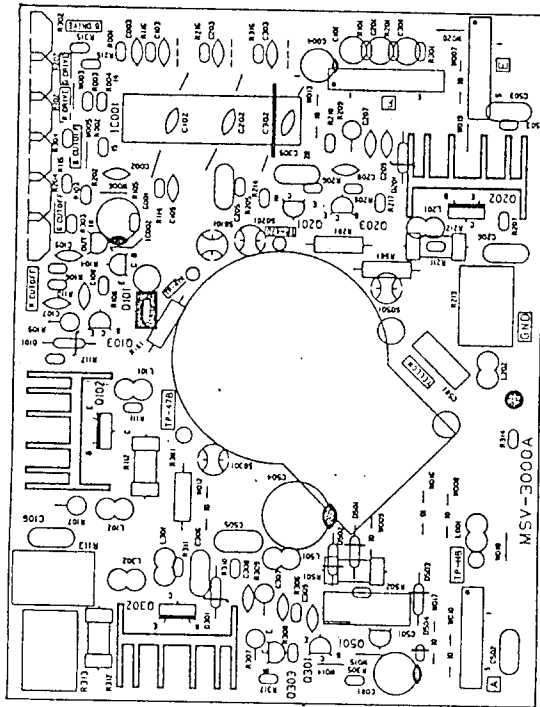

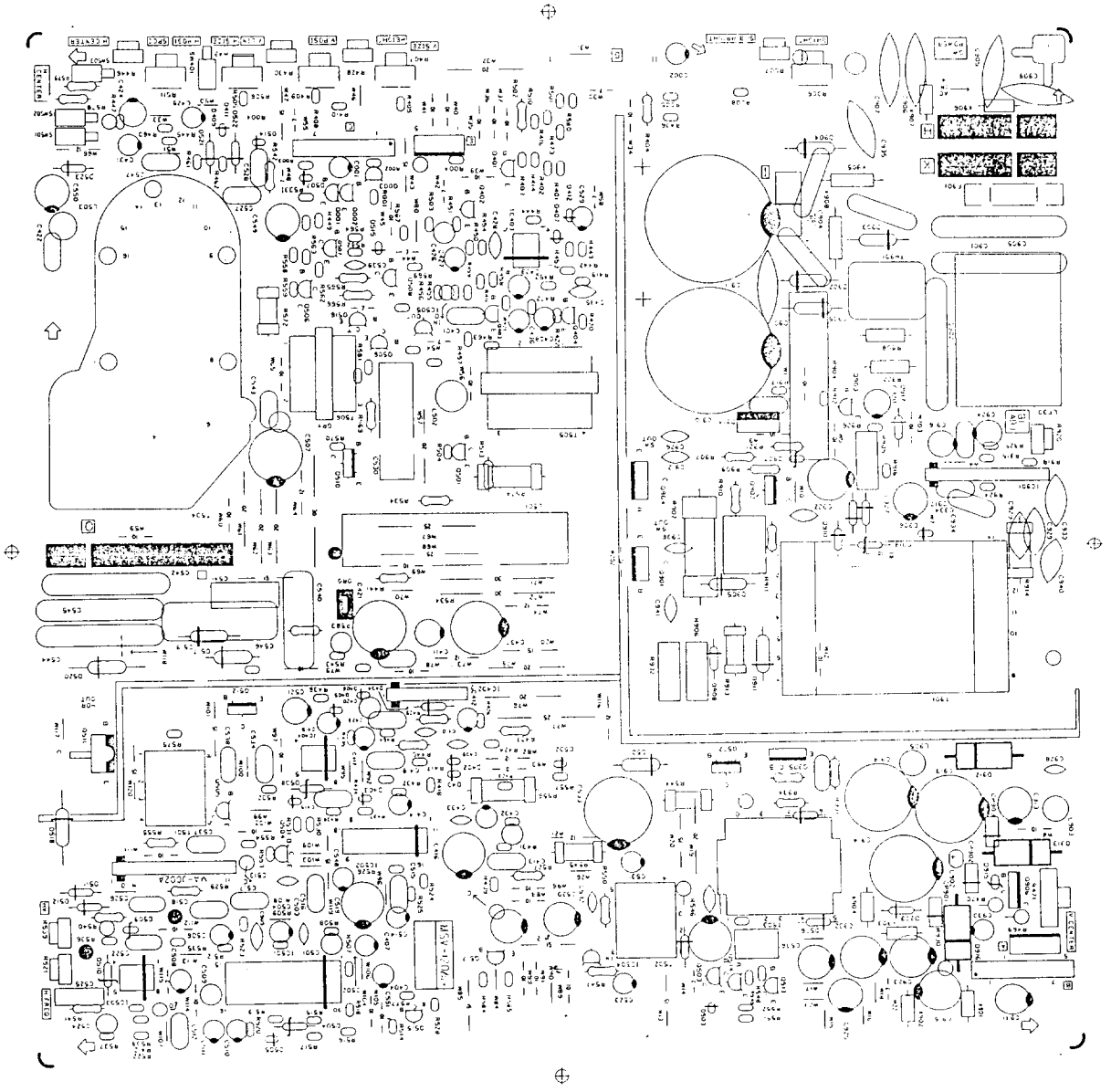

SV-775LR

MSV-3000A

CK10526-E01-2

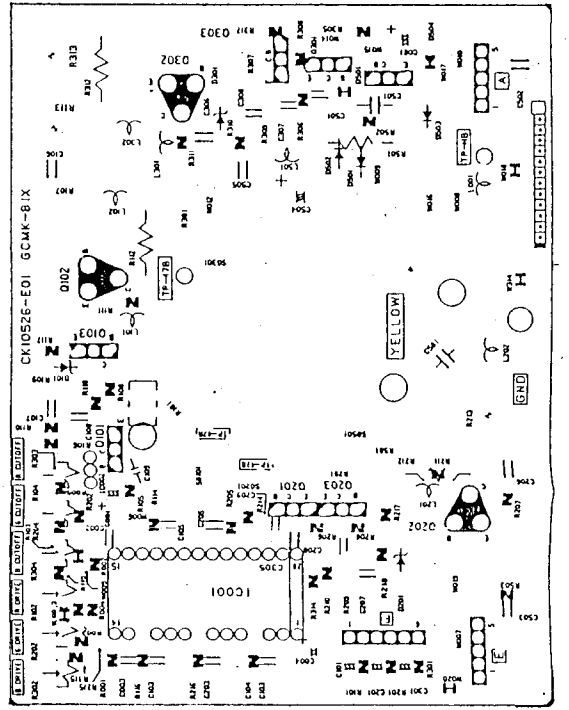
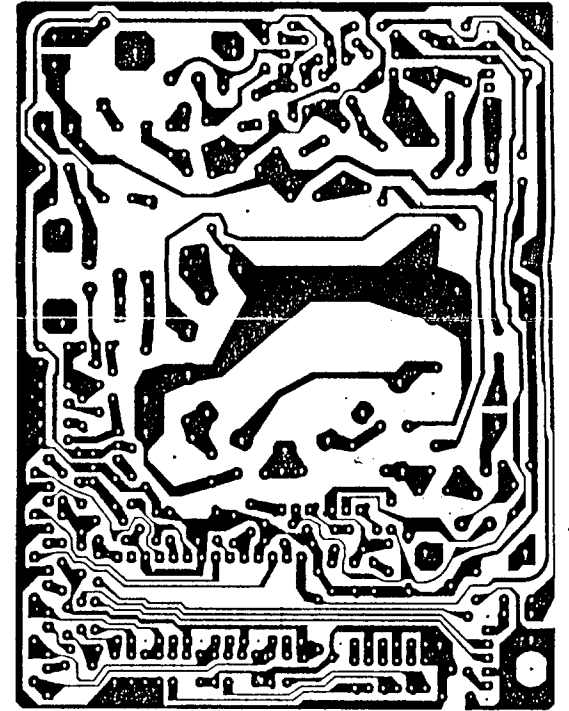
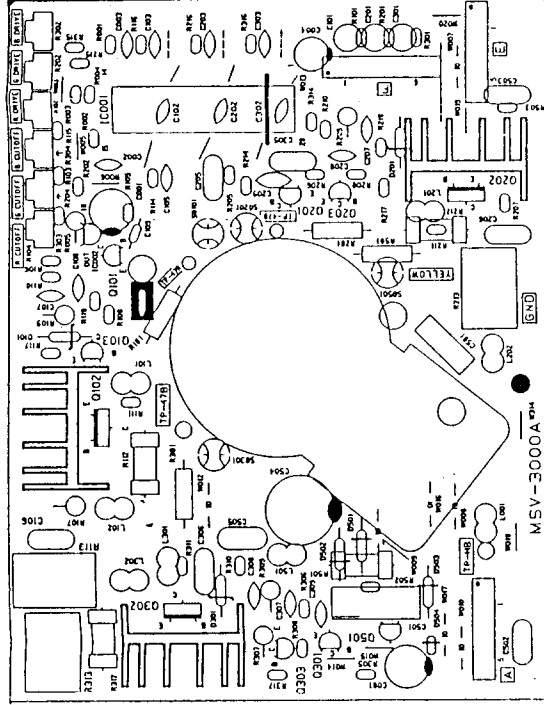

SV-775LR
MAIN PCB ASSY
MSV-1219A
CK10525-H01-1

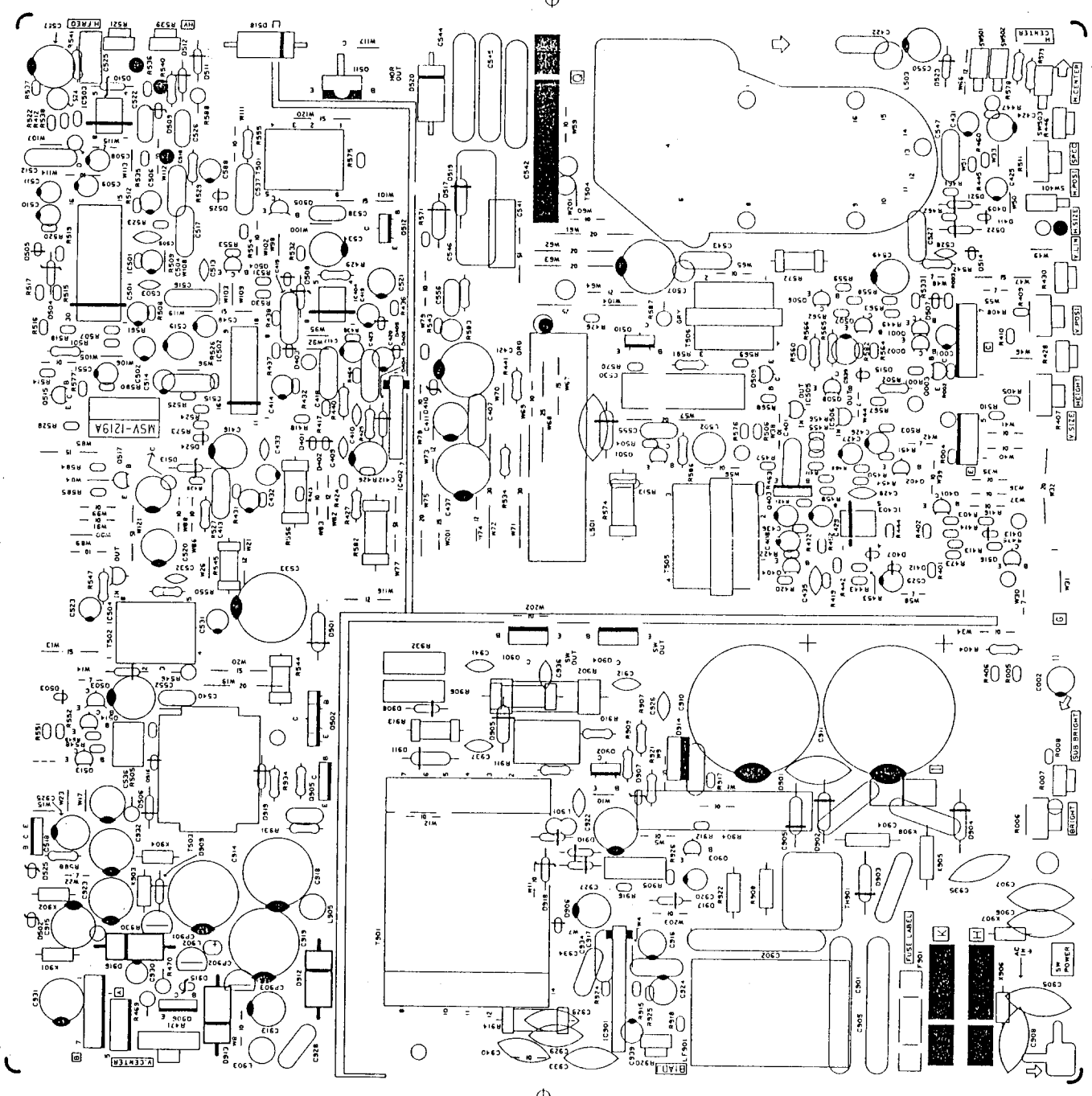

SV-775LR
MSV-6000A CK10529-G01-2

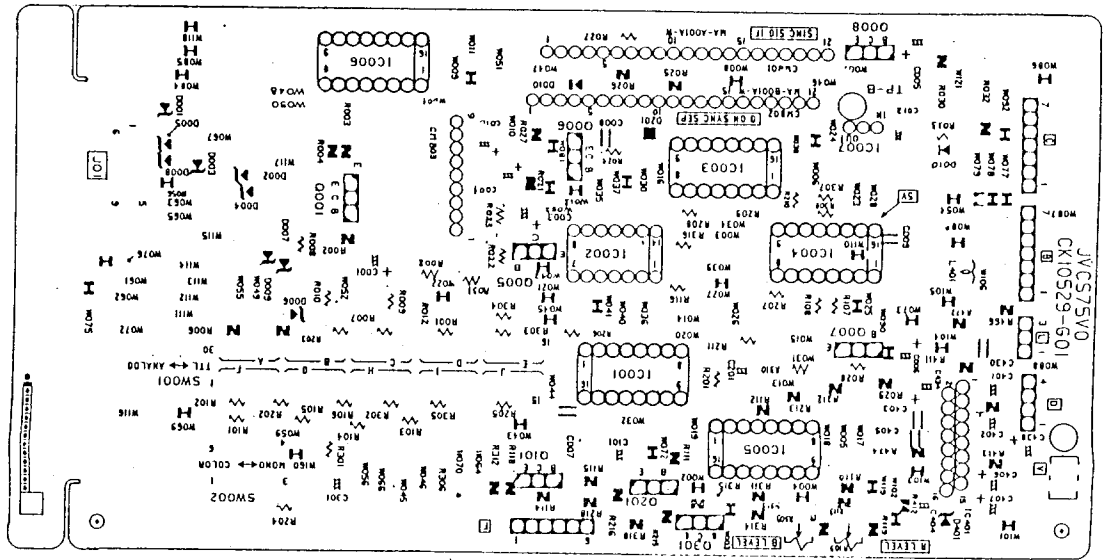
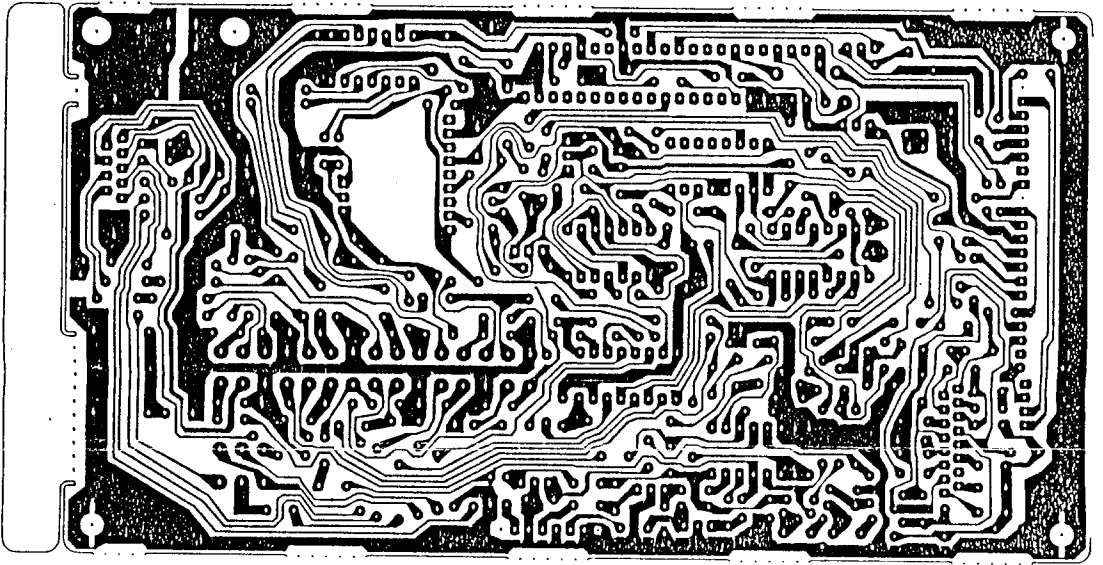
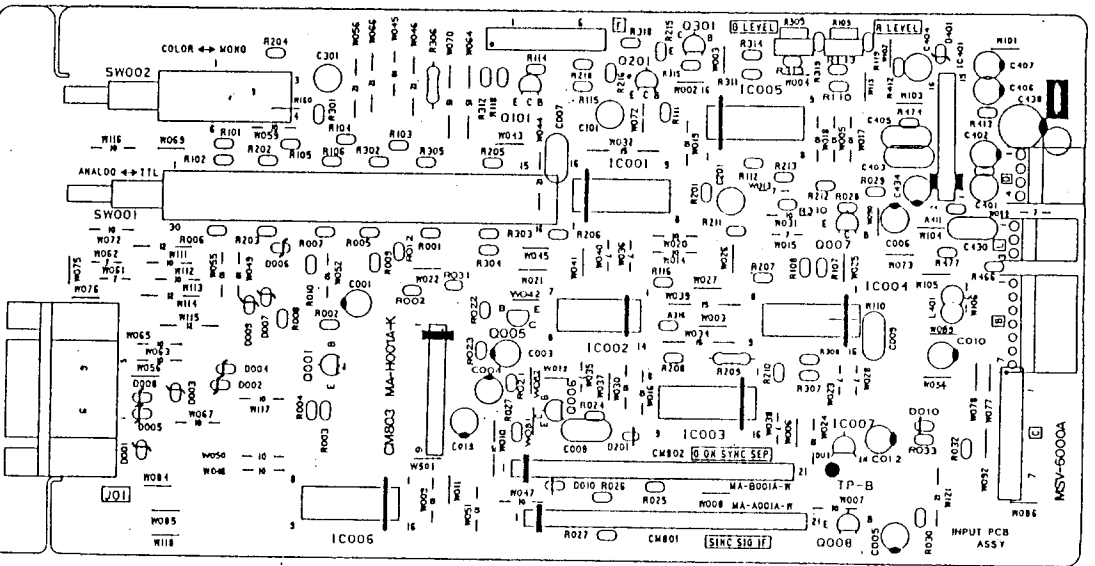

MSV-6000 (ENT) W. P. 10007
CK10529-Do1

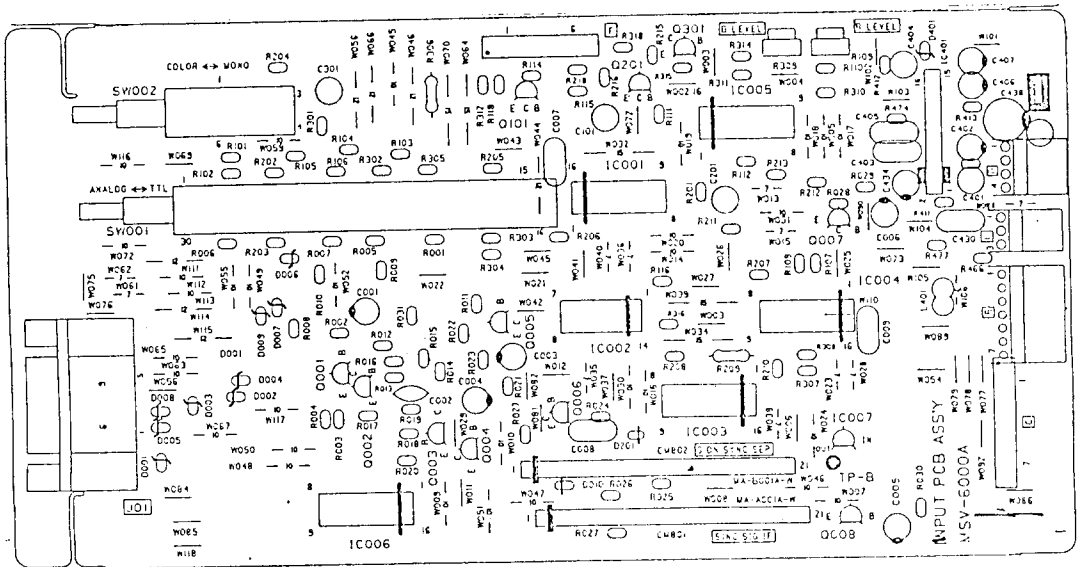
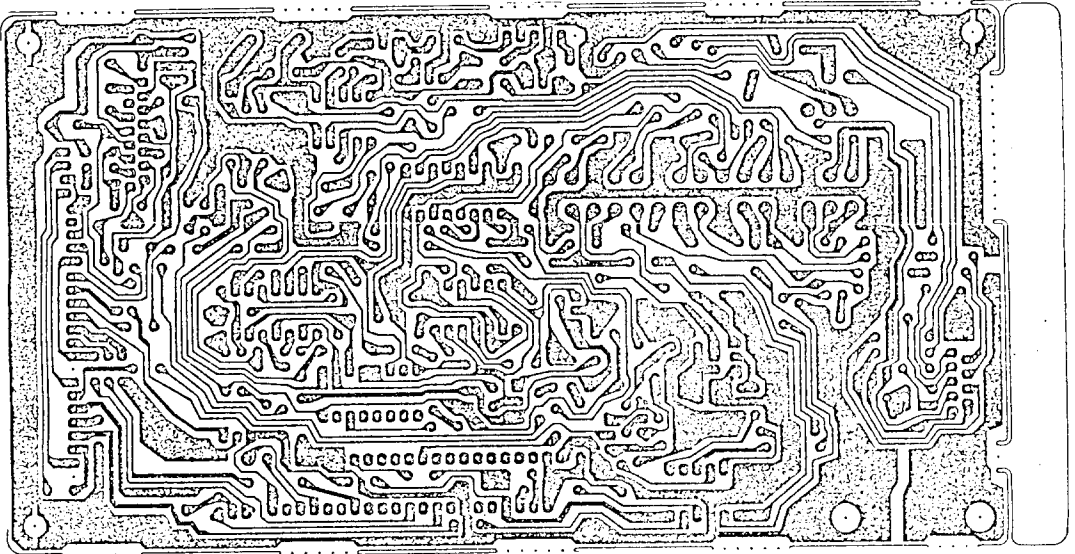
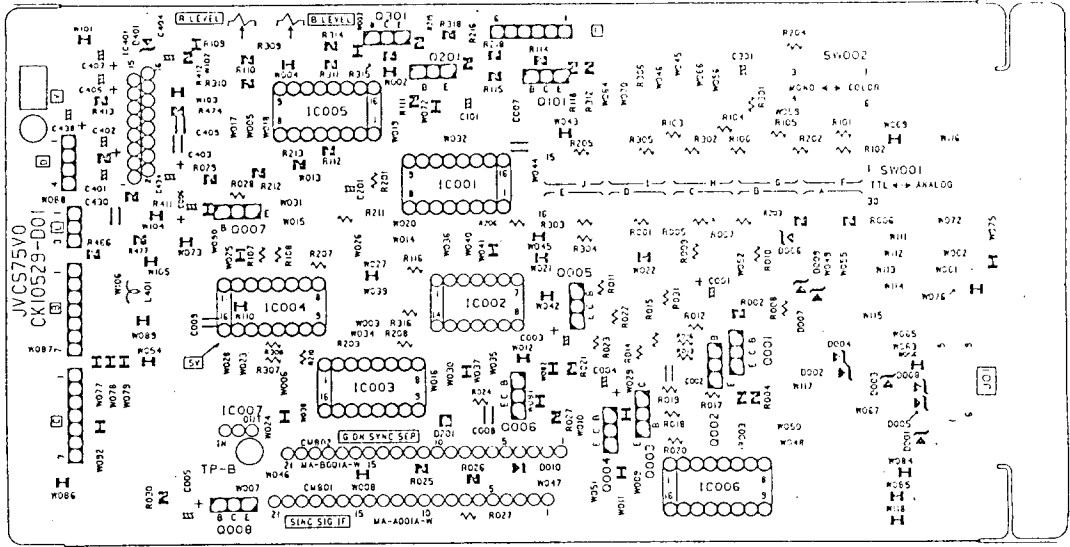

MSV-1206A (MAIN PCB ASSY)
Φ CK10525-DO1

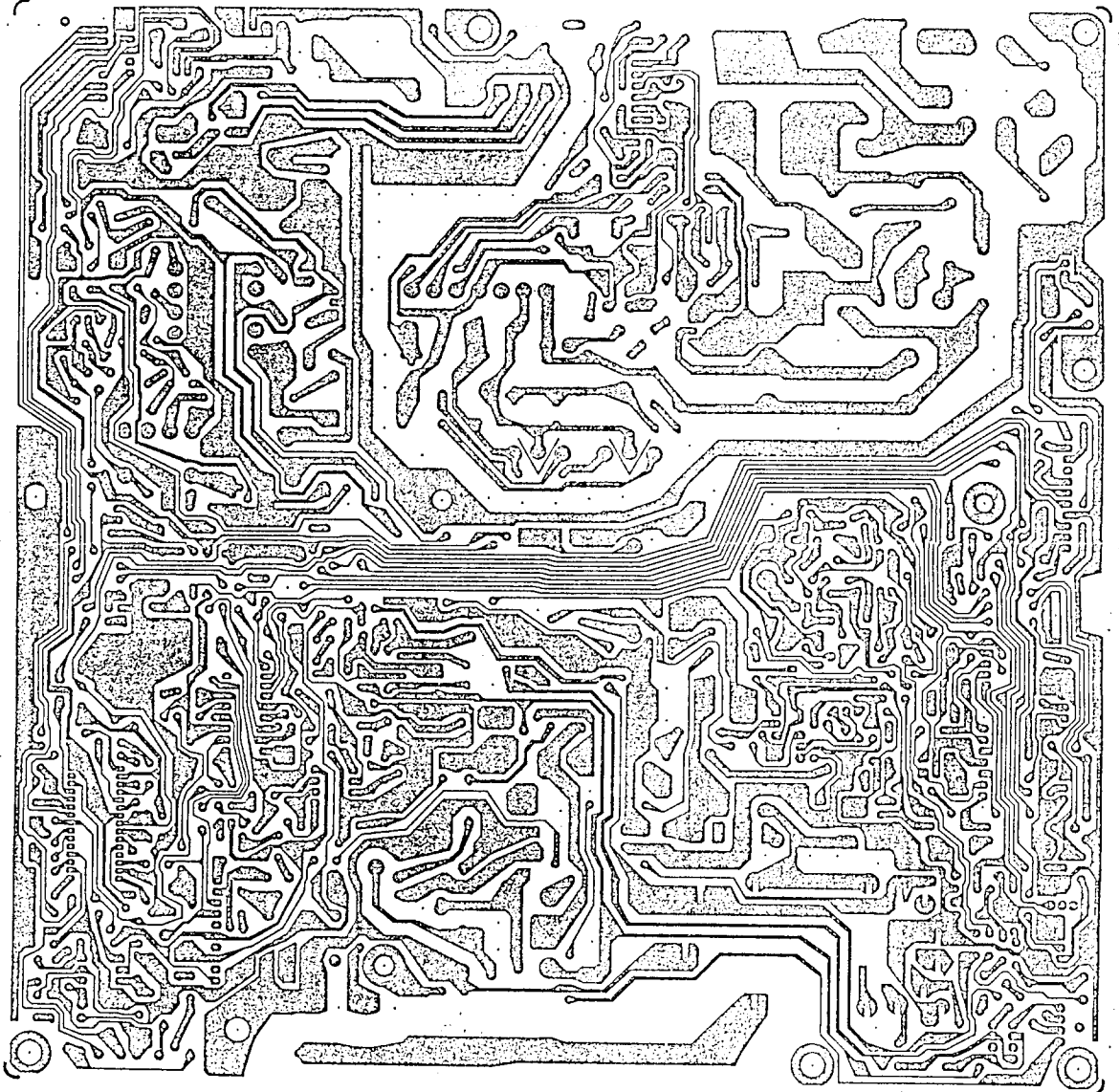

107

108

109

110

MSV-1066A (MAIN PCB ASSY)

CK10525-001
GOMK-81X

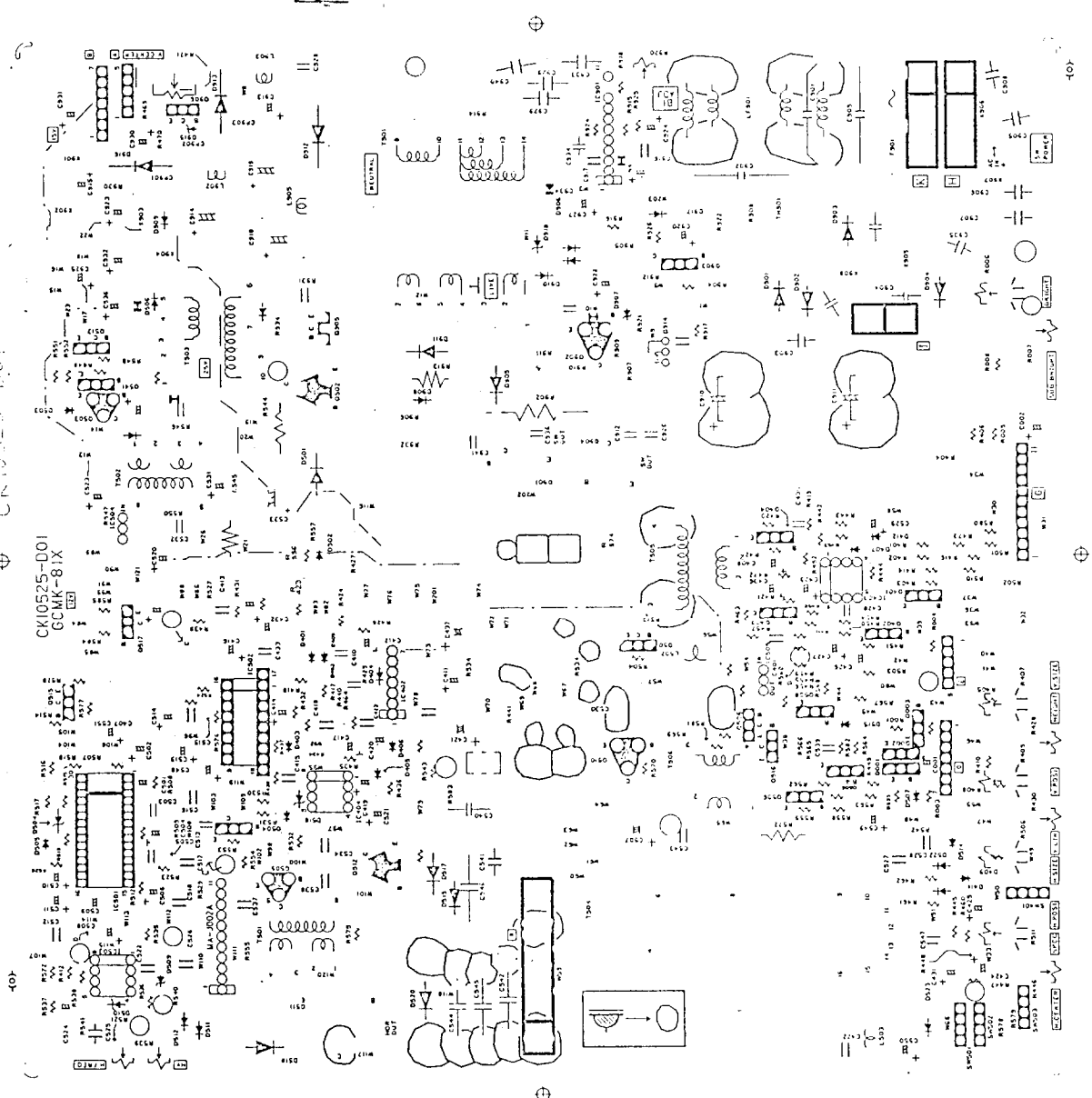

401

401

401

401

BLOCK DIAGRAM

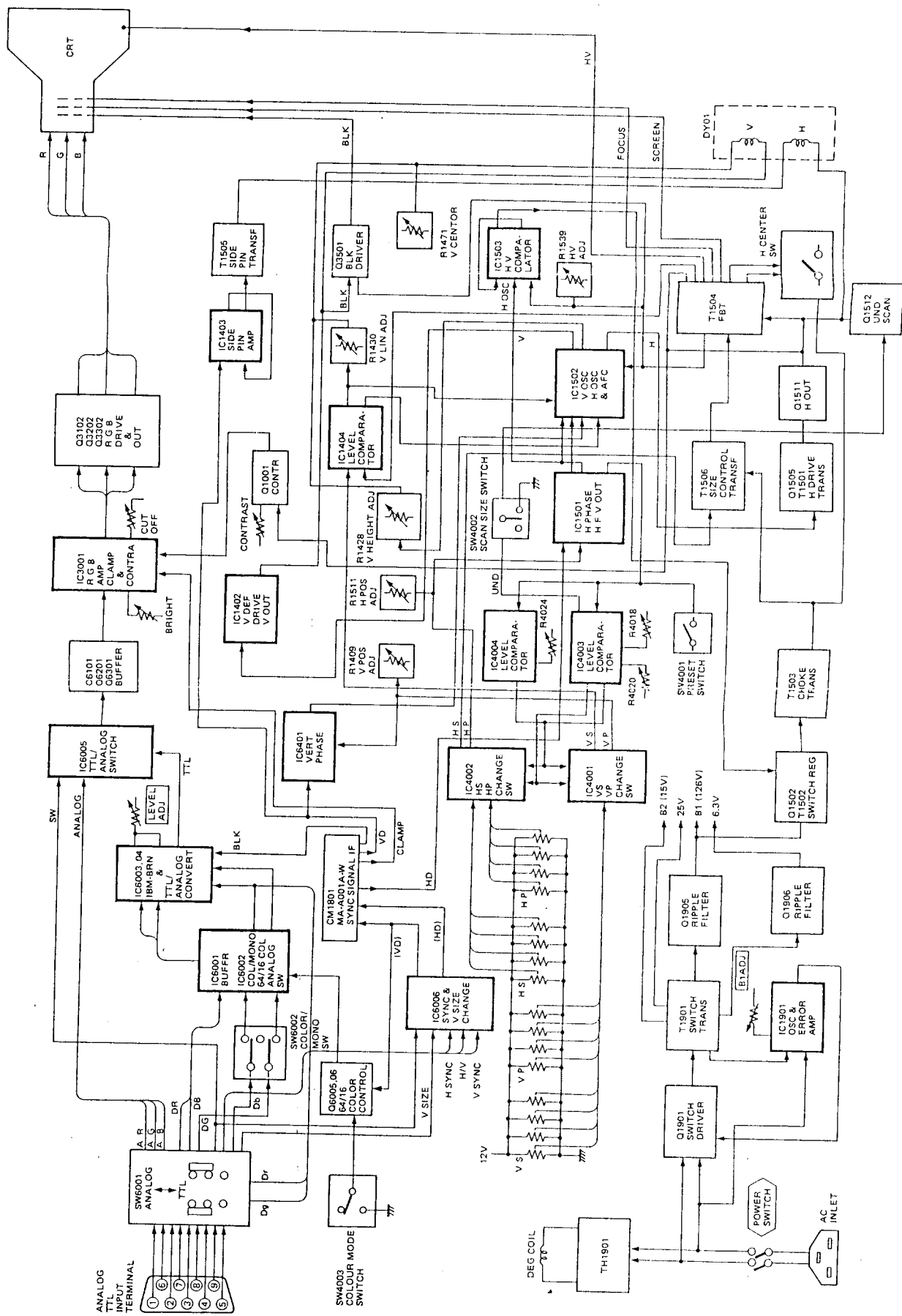

SV-775LR
MSV-1219A

MAIN PCB ASSY
CK10525-H01-1

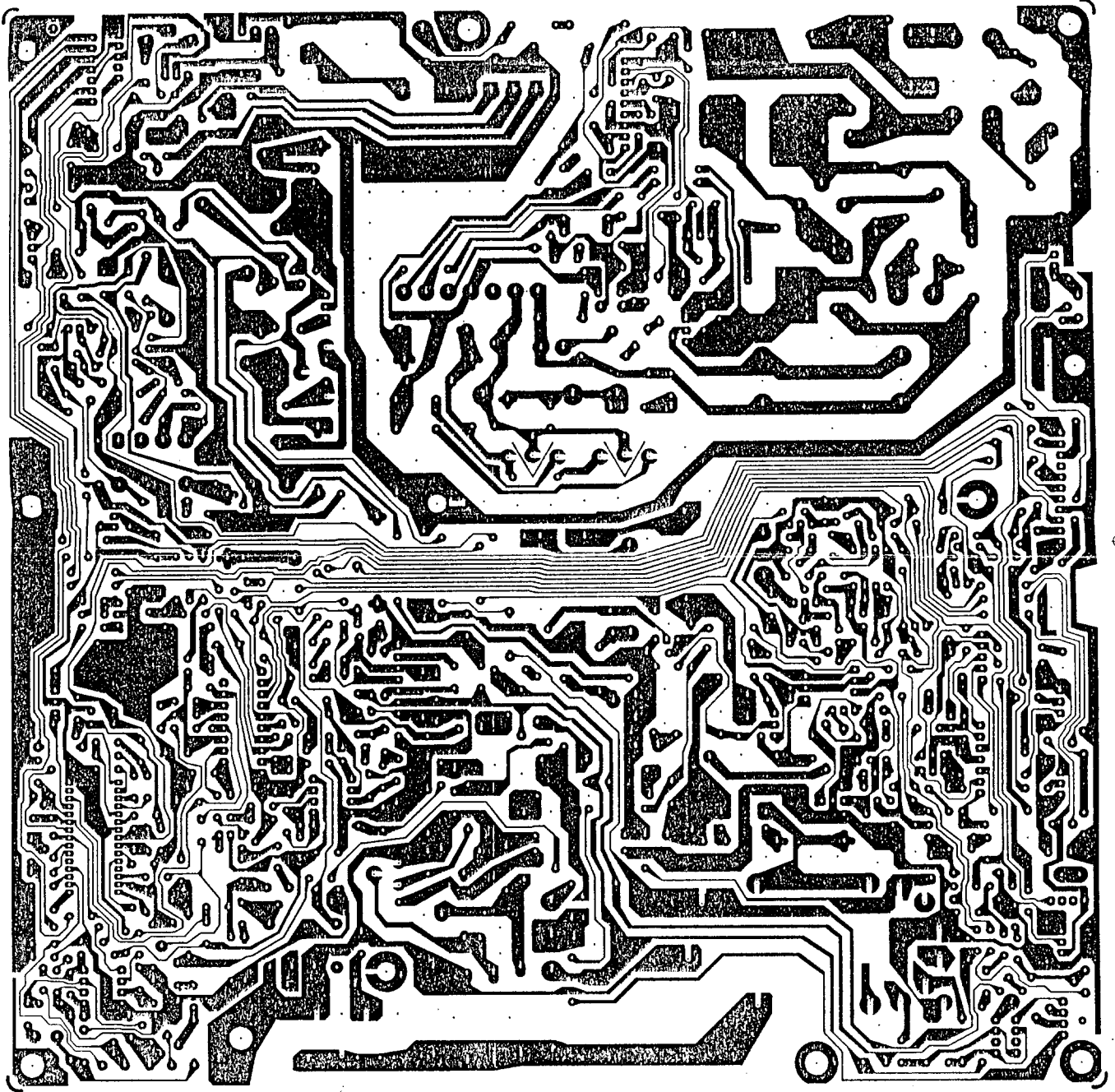

SV-775LR
MSV-1219A

MAIN PCB ASSY
CK10525-H01
CK10525-H01-1

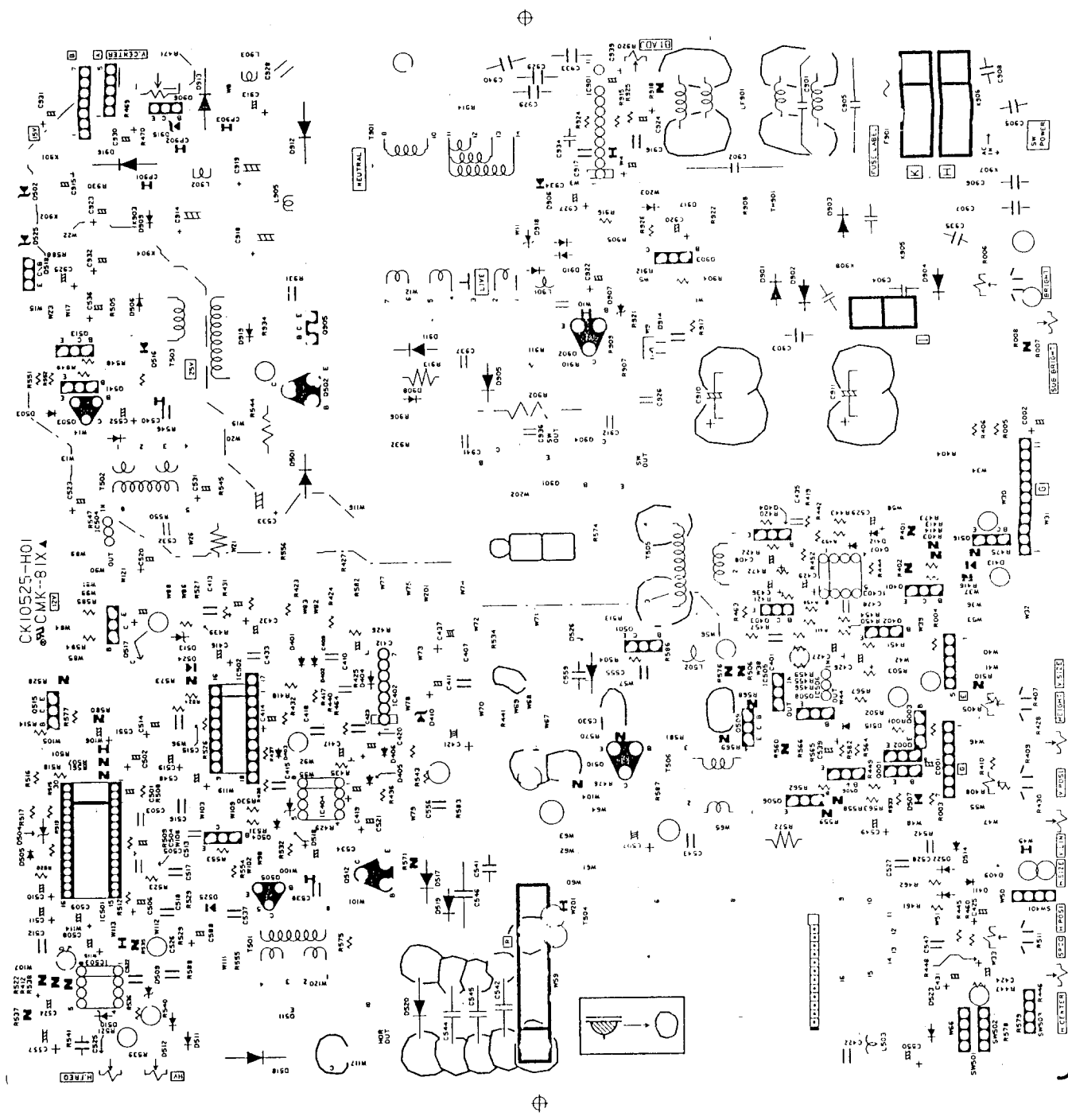

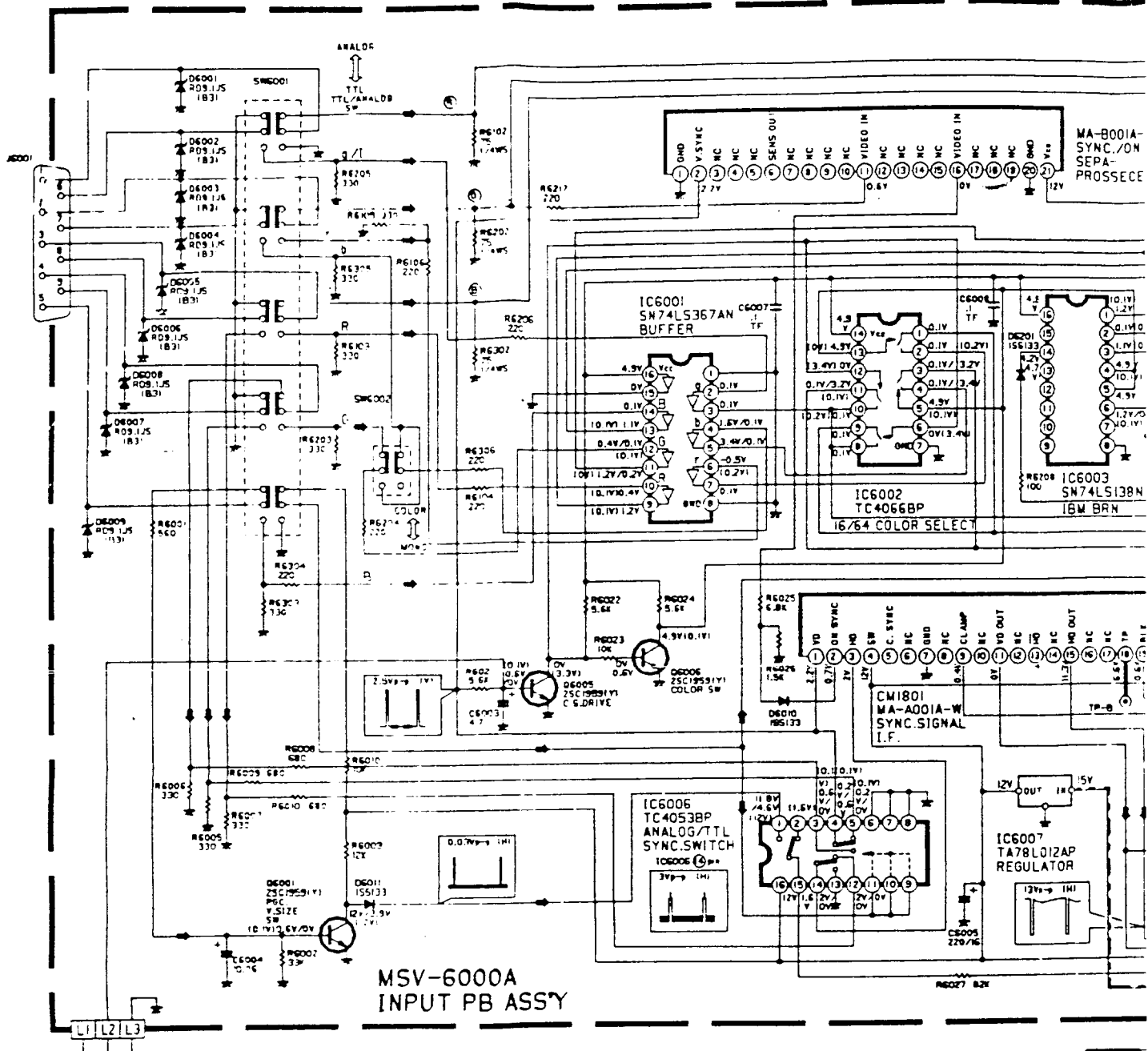

MSV-6000A
INPUT PB ASSY

	ANALOG	TTL
1	R	GND
2	G	'
3	B	R
4	-H/V	G
5	V.SIZE	B
6	R.GND	g/I
7	B.GND	b'
8	B.GND	H.SYNC
9	GND	V.SYNC

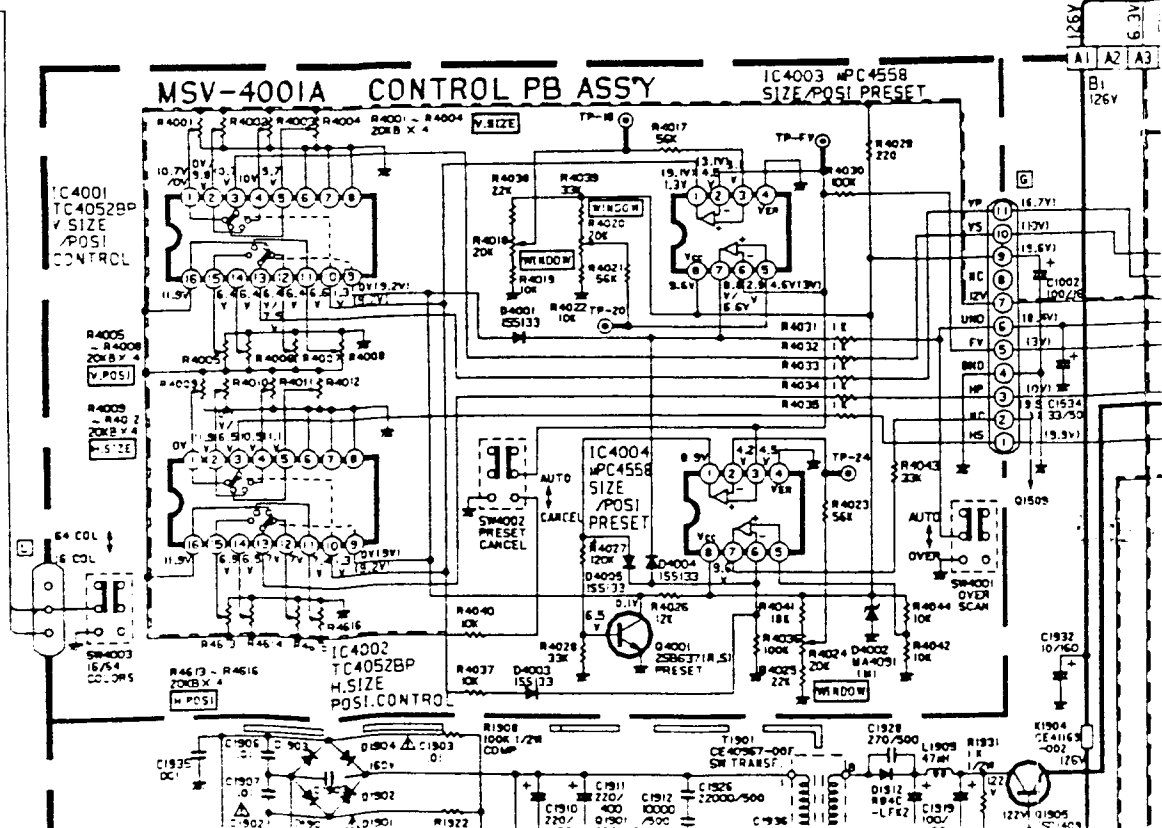

MSV-4001A CONTROL PB ASSY

IC4003 PC4558
SIZE / POSI PRESET

IC4004 PC4558
SIZE / POSI PRESET

IC4002 TC4052BP
H.SIZE
POSI CONTROL

IC4001 TC4052BP
V.SIZE
/ POSI CONTROL

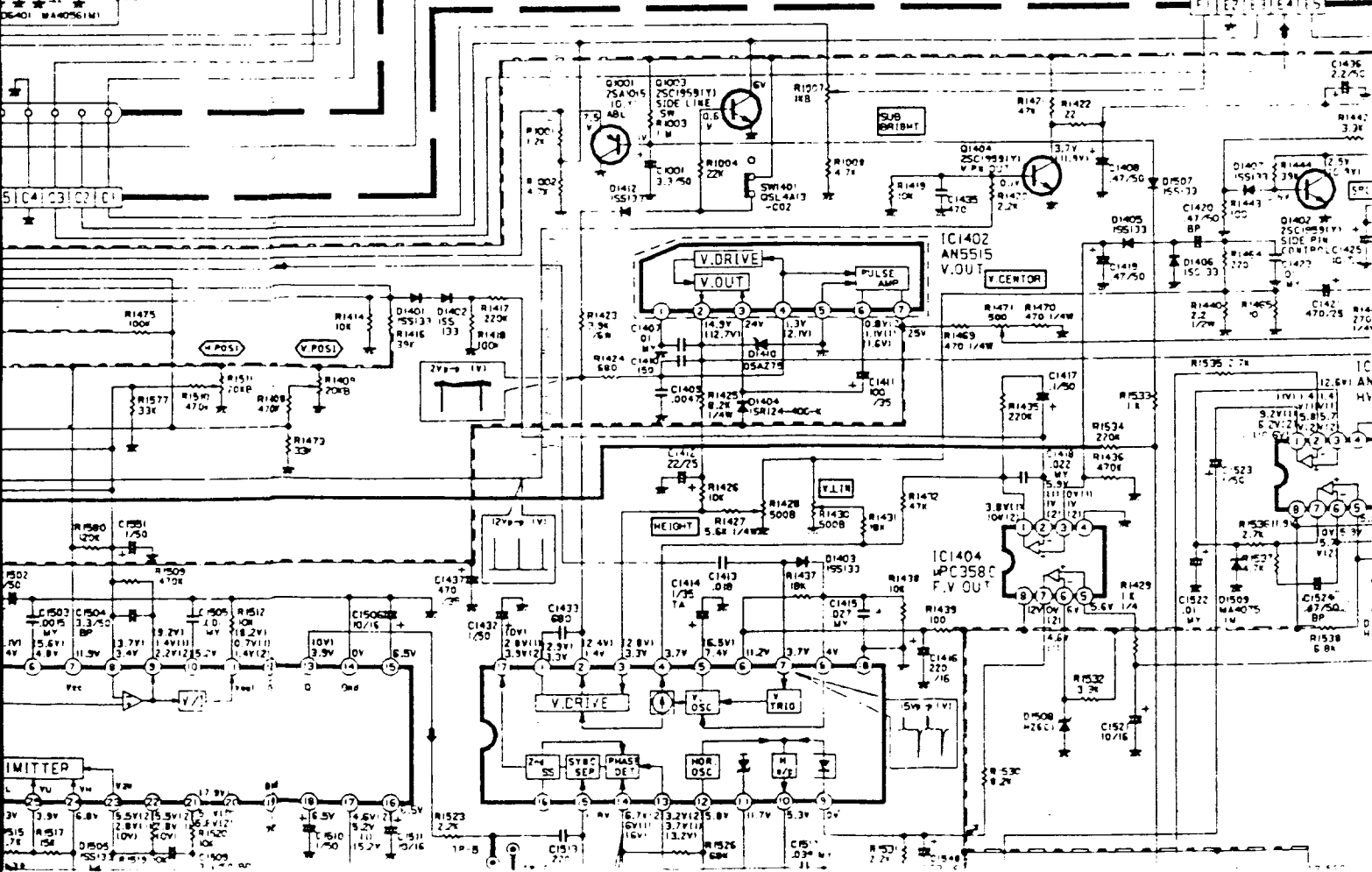
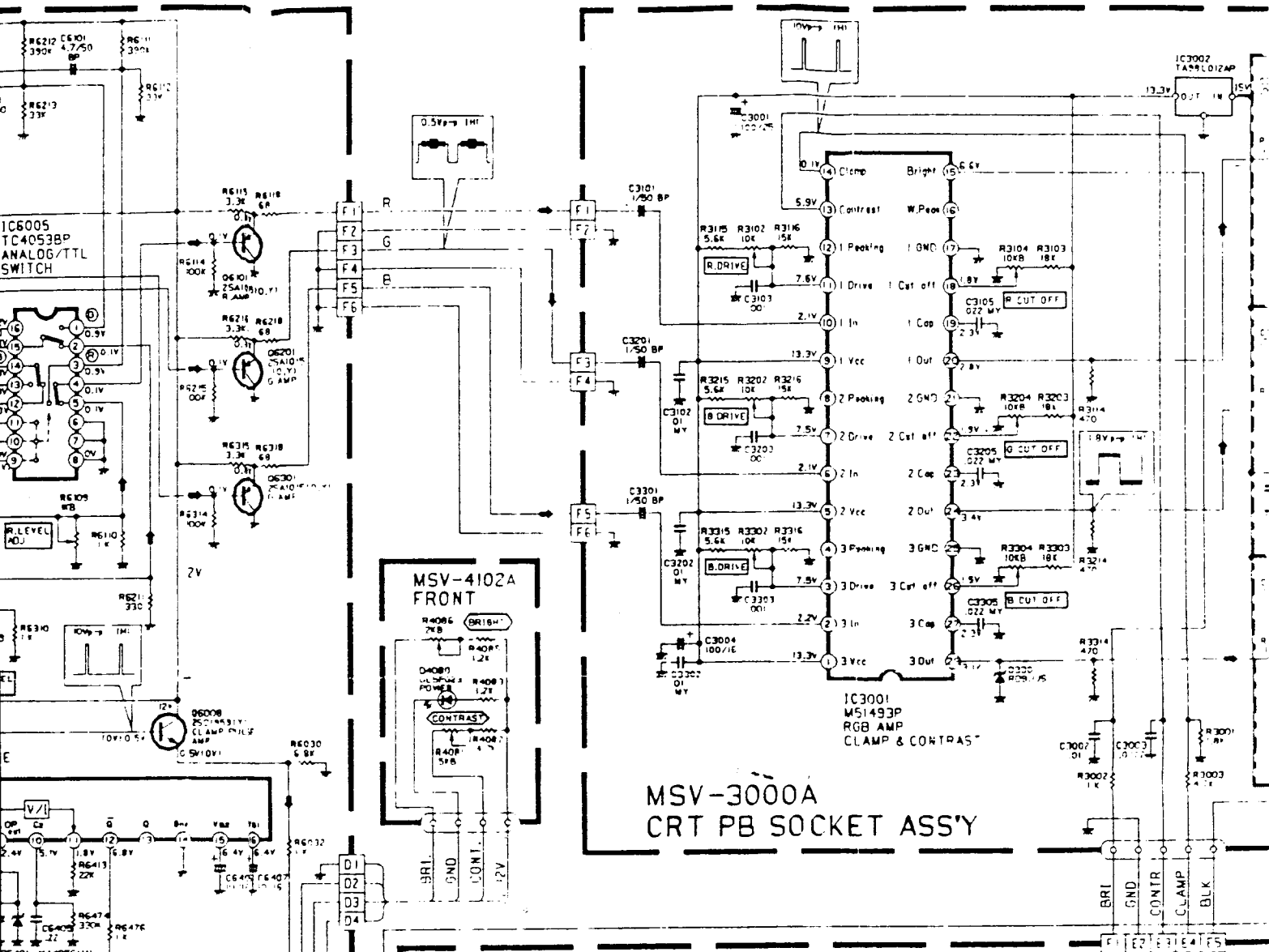

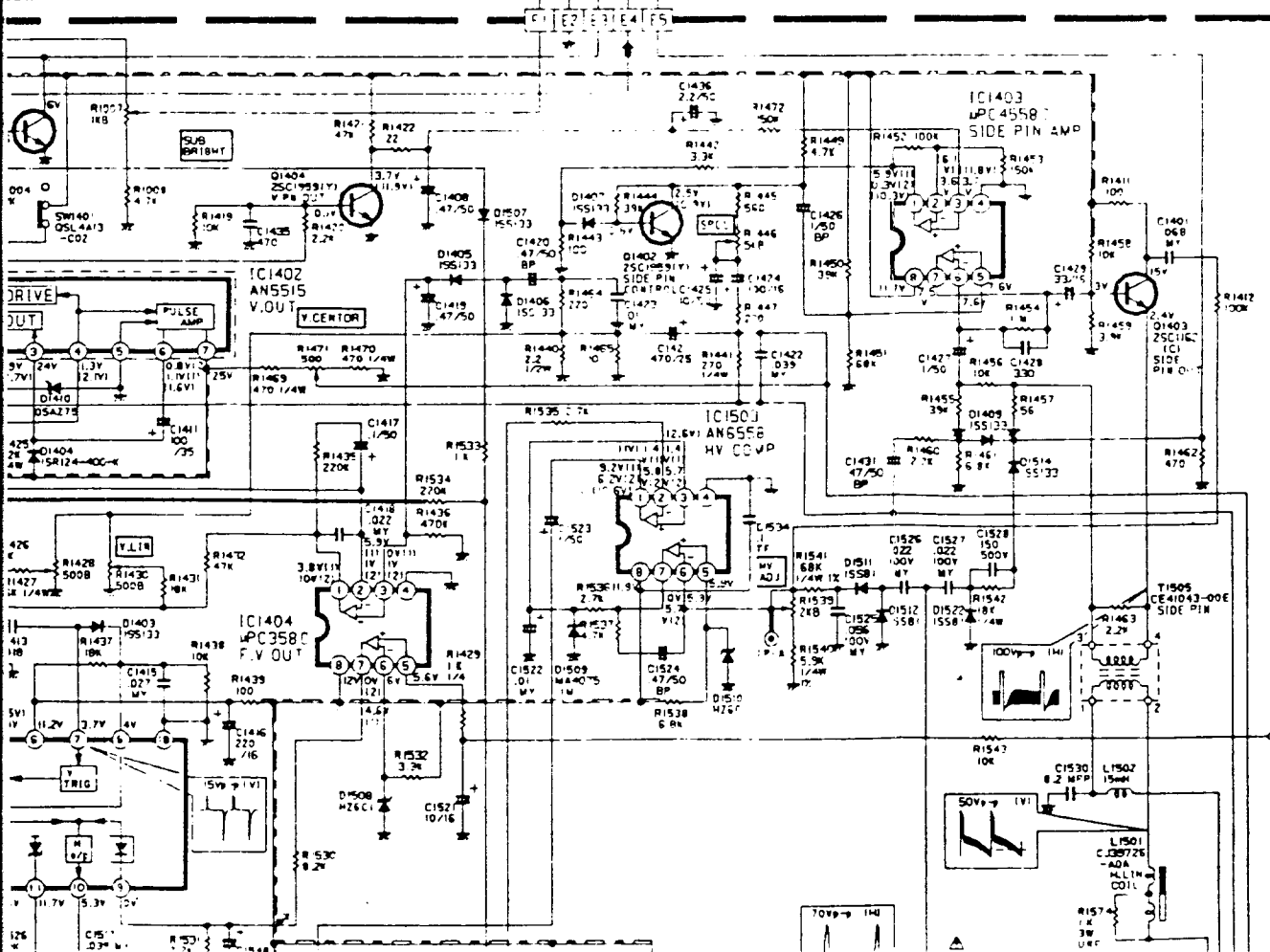
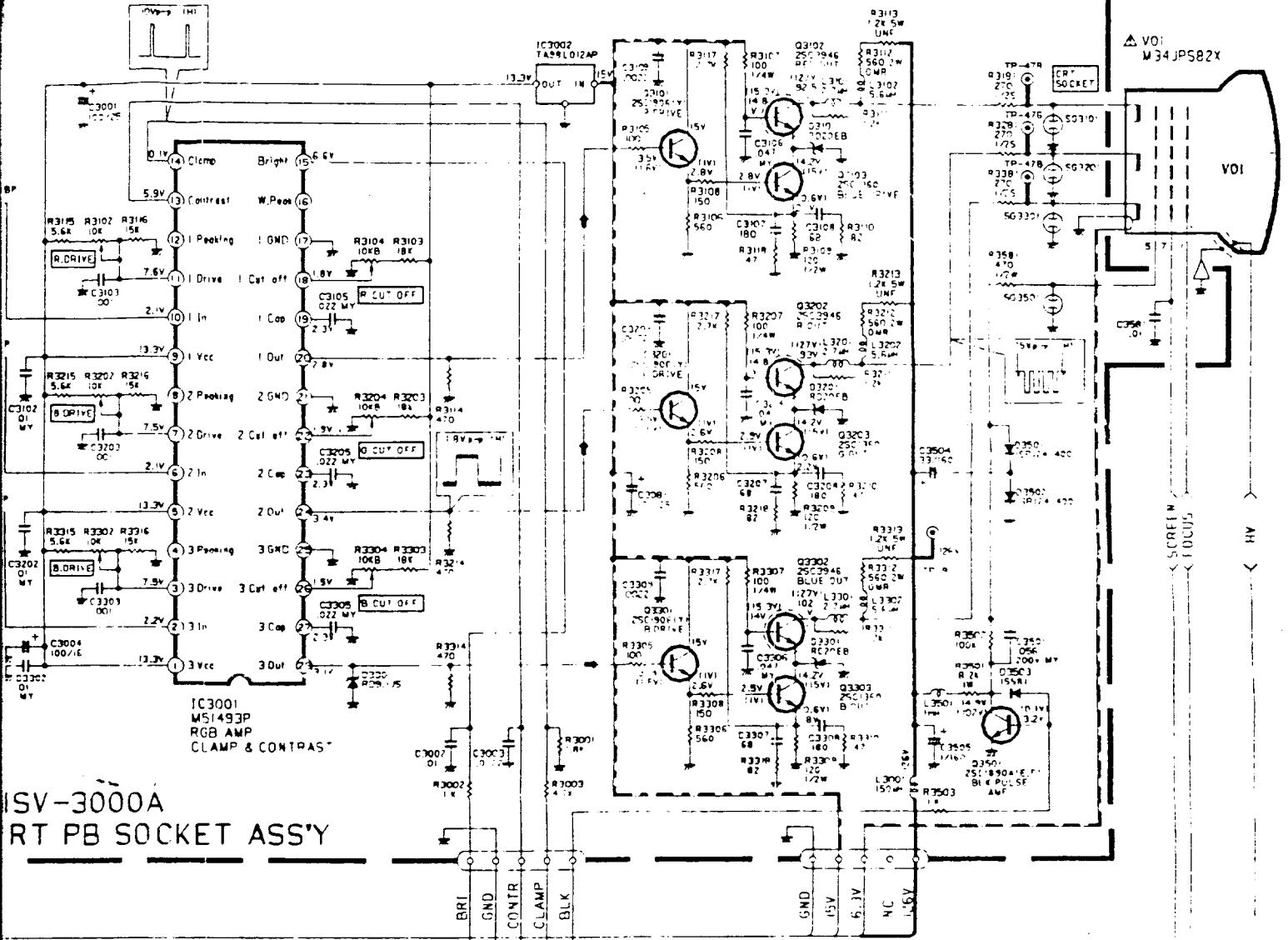

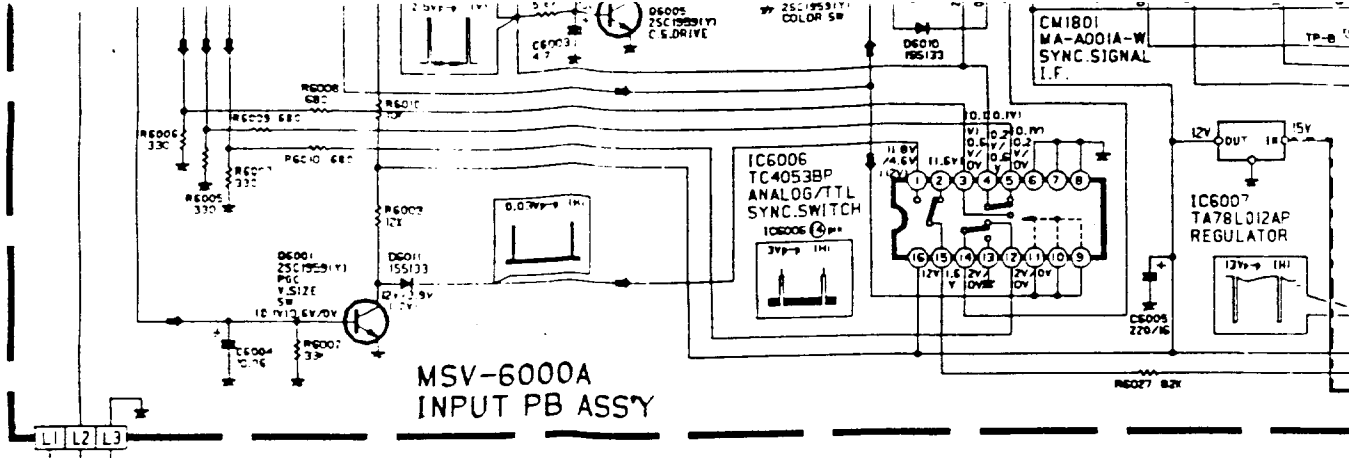

MSV-6000A
INPUT PB ASSY

	ANALOG	TTL
1	R	GND
2	G	r
3	B	r
4	-H/V	B
5	V.SIZE	B
6	R.GND	B/I
7	B.GND	b
8	B.GND	H.SYNC
9	GND	V.SYNC

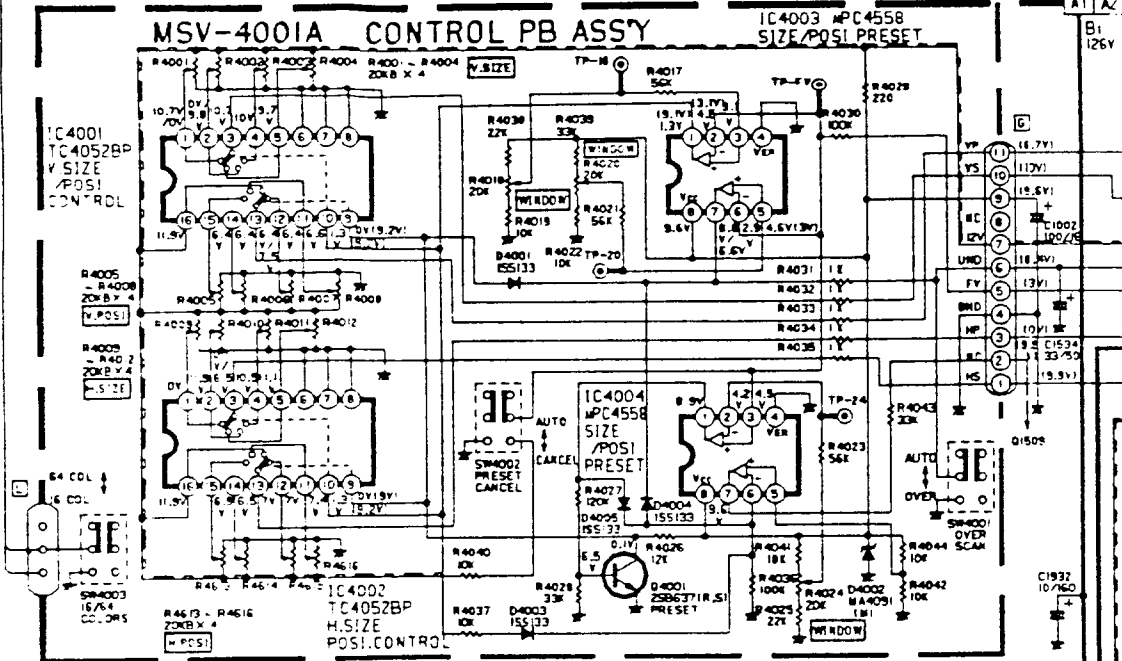

MSV-4001A CONTROL PB ASSY

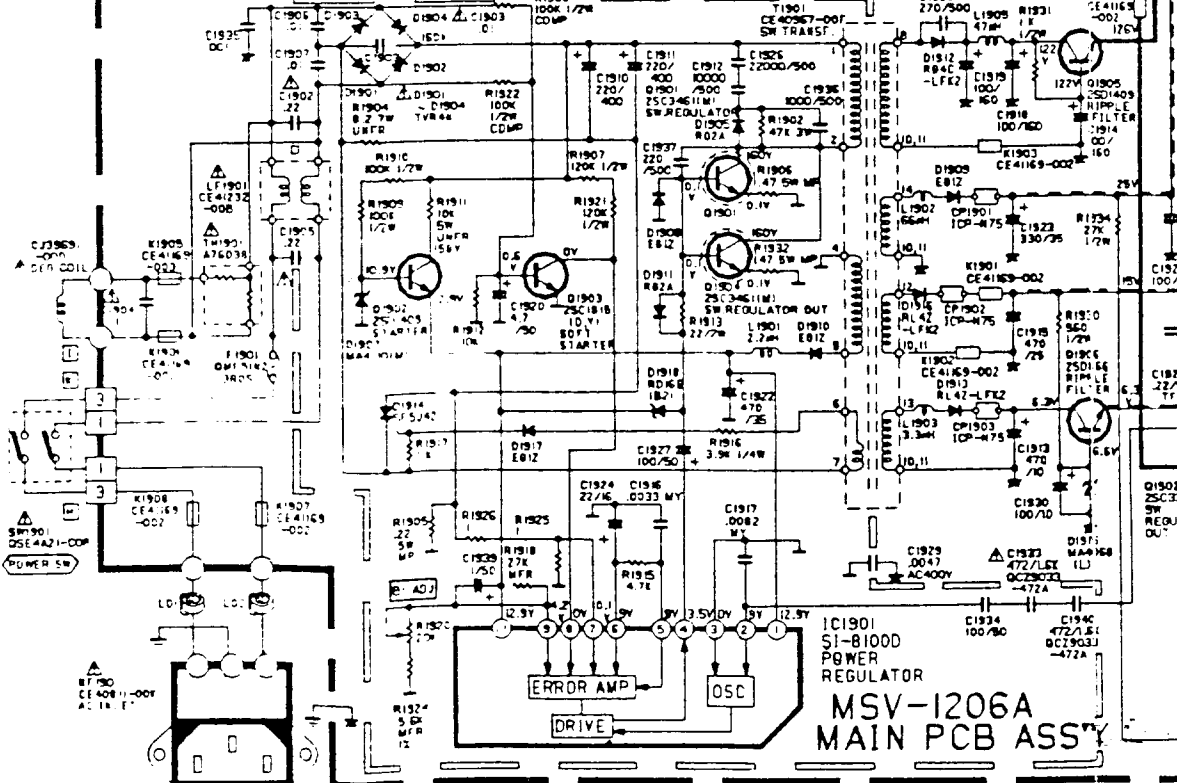

MSV-1206A
MAIN PCB ASSY

REMARK
 1 Waveform voltage was measured by AC100V-AC240V (f_w=15.75 KHz)
 2 Voltage in Schematic Diagram was measured by RGB Analog Input Signal
 3 Voltage in Schematic Diagram
 (1) f_w=15.75 KHz (2) f_w=31.5 KHz () = No Signal Input

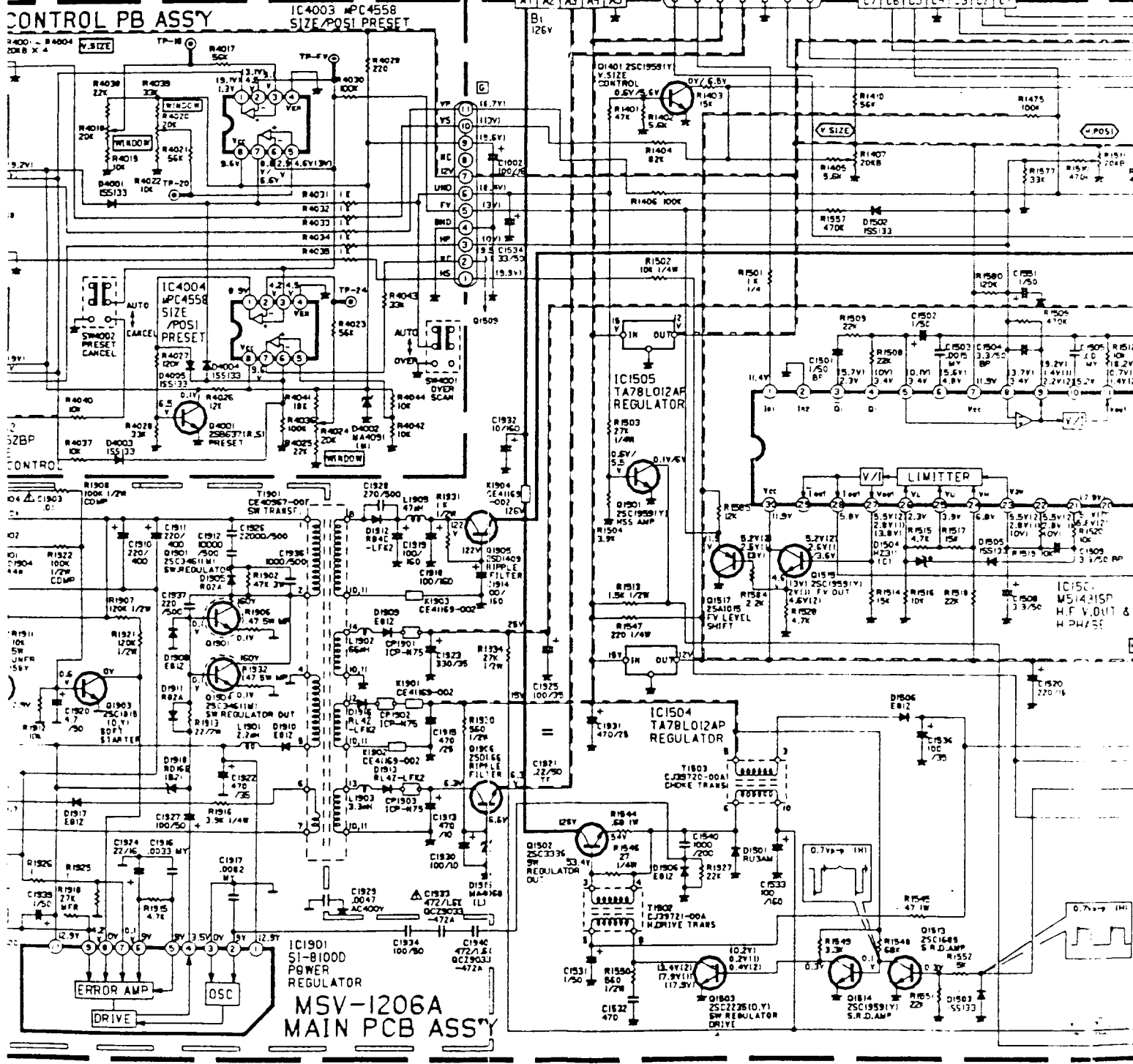
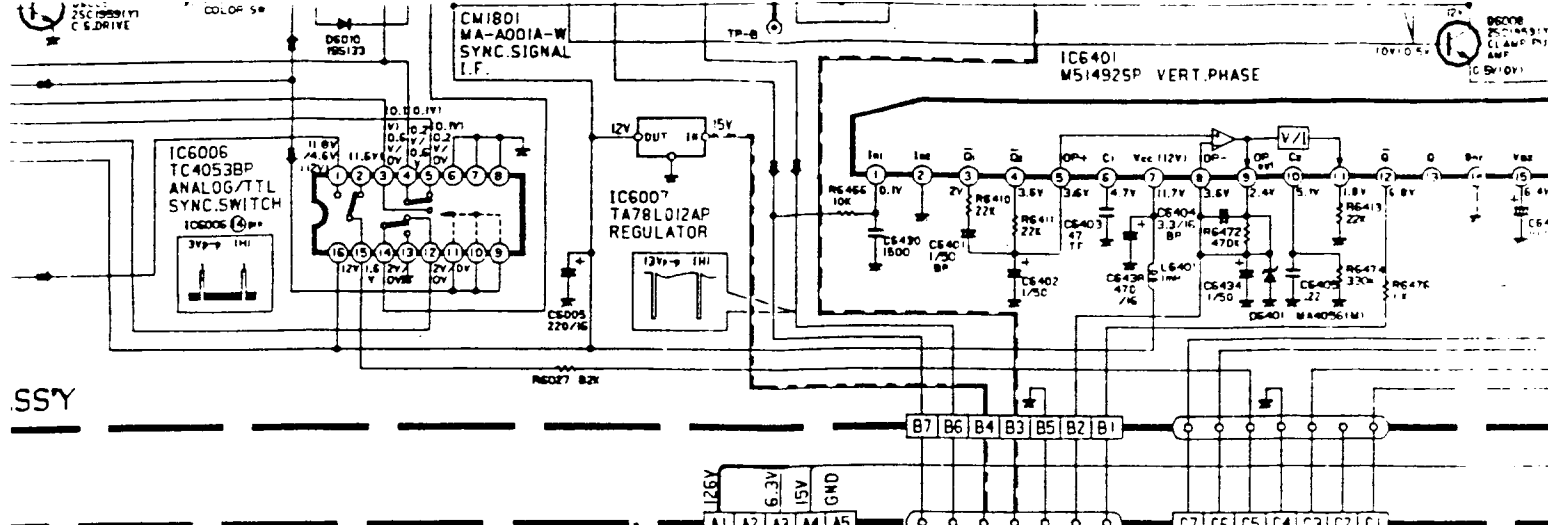

m voltage was measured by AC100V-AC240V (f=15.75 KHz)
 in Schematic Diagram was measured by RGB Analog Input Signal
 in Schematic Diagram
 15.75 KHz (2): f=31.5KHz () = No Signal Input

IC6401
M514925P VERT. PHASE

IC500
M51493P
RGB AMP
CLAMP & CONTRAS

MSV-3000A CRT PB SOCKET ASS'Y

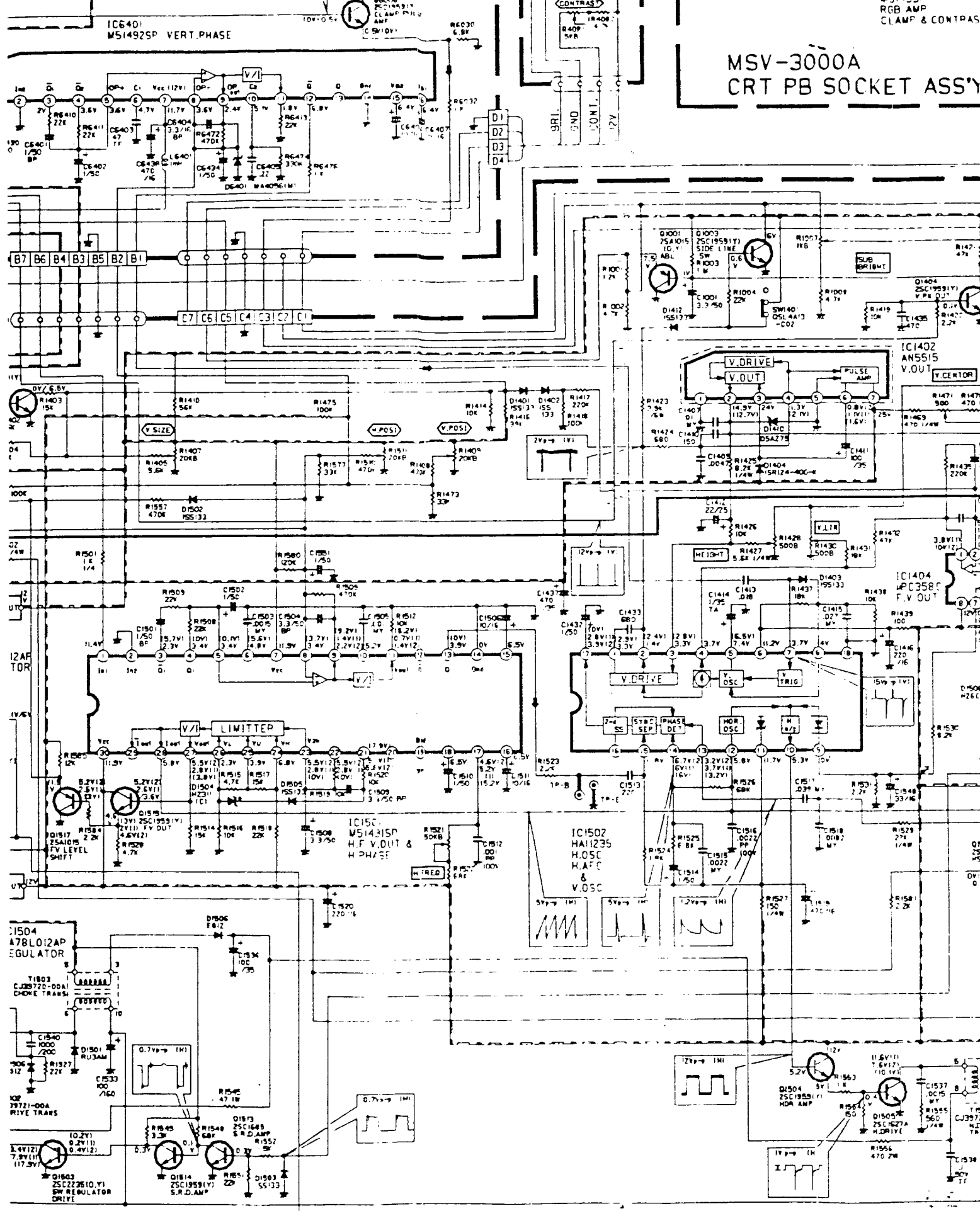

B7 B6 B4 B3 B5 B2 B1

C7 C6 C5 C4 C3 C2 C1

12AF TOR

12V 10V 8V 6V 5V 4V 3V 2V 1V

UT

12V 10V 8V 6V 5V 4V 3V 2V 1V

12V 10V 8V 6V 5V 4V 3V 2V 1V

12V 10V 8V 6V 5V 4V 3V 2V 1V

12V 10V 8V 6V 5V 4V 3V 2V 1V

12V 10V 8V 6V 5V 4V 3V 2V 1V

12V 10V 8V 6V 5V 4V 3V 2V 1V

12V 10V 8V 6V 5V 4V 3V 2V 1V

12V 10V 8V 6V 5V 4V 3V 2V 1V

12V 10V 8V 6V 5V 4V 3V 2V 1V

12V 10V 8V 6V 5V 4V 3V 2V 1V

12V 10V 8V 6V 5V 4V 3V 2V 1V

12V 10V 8V 6V 5V 4V 3V 2V 1V

12V 10V 8V 6V 5V 4V 3V 2V 1V

MSV-3000A
CRT PB SOCKET ASS'Y

IC3001
MS1493P
RGB AMP
CLAMP & CONTRAS*

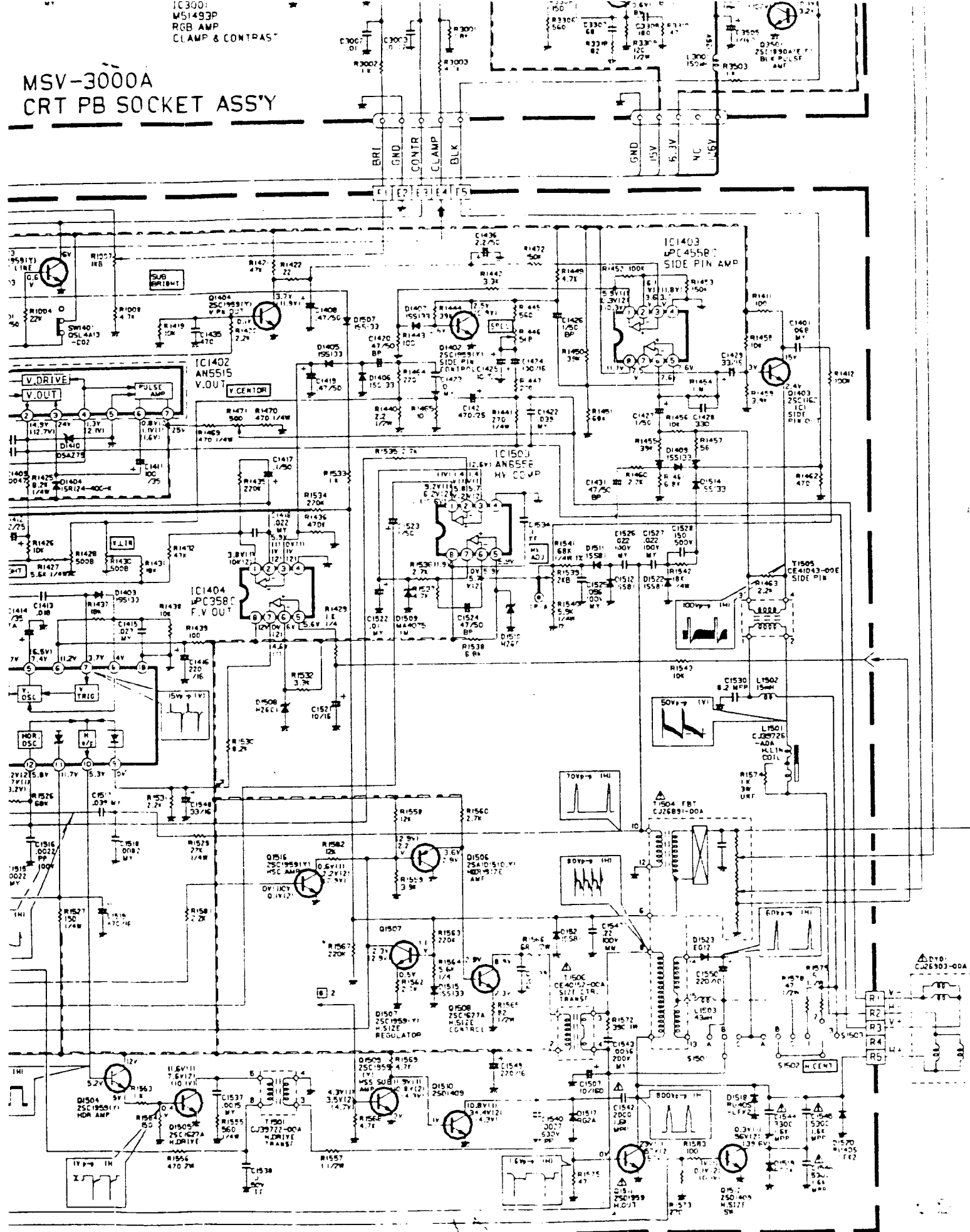

SV-775E