



THE QUALITY GOES IN BEFORE THE NAME GOES ON  
PERSONAL COMPUTER SYSTEMS

---

**Z-170 PC SERIES  
PORTABLE COMPUTER  
OWNERS MANUAL**

**ZENITH**  
data  
systems

**Z-170 PC SERIES PORTABLE COMPUTER OWNERS MANUAL**

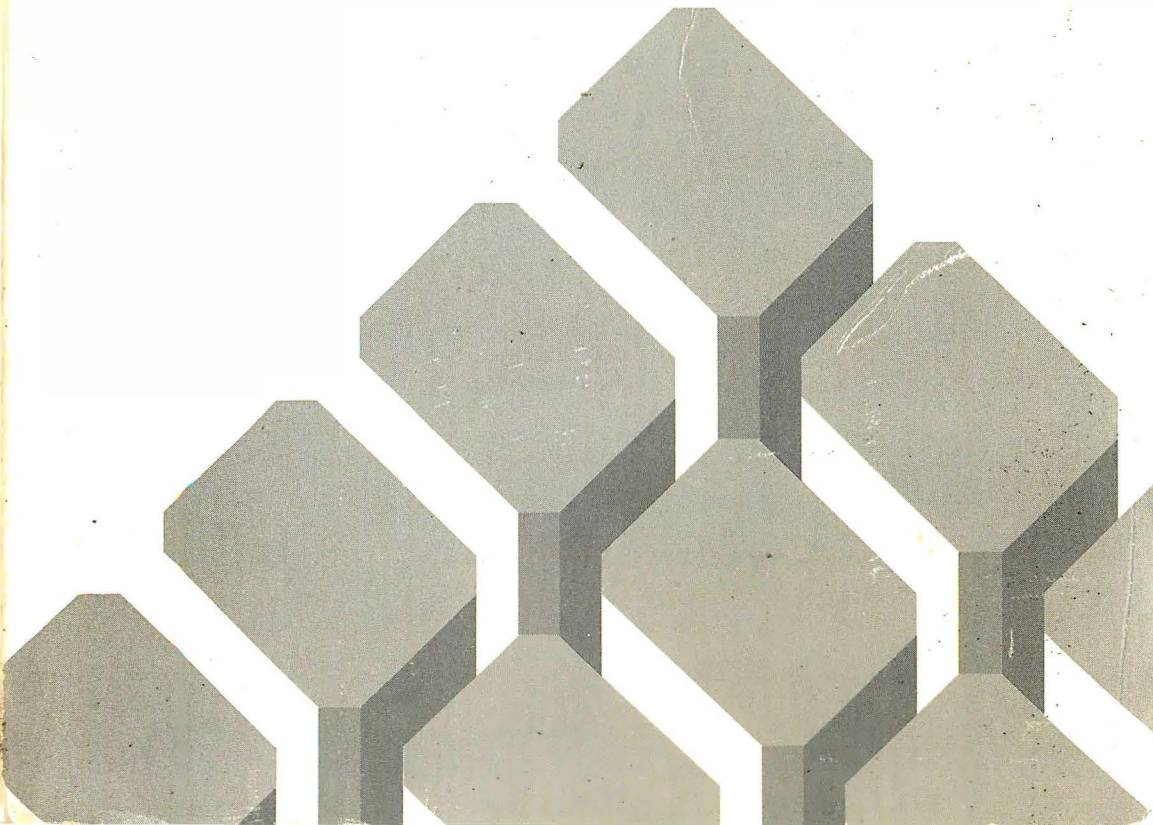

## REGULATORY AND REGISTRATION INFORMATION

**WARNING** — This equipment has been certified to comply with the limits for a Class B computing device, pursuant to Subpart J of Part 15 of FCC Rules. Only peripherals (computer input/output devices, terminals, printers, etc.) certified to comply with the Class B limits may be attached to this computer. Operation with non-certified peripherals is likely to result in interference with radio and TV reception.

**NOTE:** The I/O cables that interconnect between this computer and any peripheral (such as a printer, modem, etc.) must be shielded in order for this equipment to meet Class B emission limits.

This equipment generates and uses radio frequency energy for its operation and if not installed and used properly, that is, in strict accordance with the instruction manual, may cause interference with radio and television reception. It has been tested and found to comply with the RF emission limits for a Class B computing device which is intended to provide reasonable protection against such interference in a residential installation. However, there is no guarantee that interference will not occur in a particular installation. If this equipment does cause interference with radio or television reception, which can be determined by turning the equipment off and on, the user is encouraged to try to correct the interference by one or more of the following measures:

- Move the computing device away from the receiver being interfered with.
- Relocate (turn) the computing device with respect to the receiver.
- Reorient the receiver's antenna.
- Plug the computing device into a different AC outlet so that the computing device and receiver are on different branch circuits.
- Disconnect and remove any I/O cables that are not being used. (Unterminated I/O cables are a potential source of high RF emission levels.)
- Unplug and remove any circuit boards that not being used. (Here again, unterminated cards can be a source of potential interference.)
- Be certain that the computing device is plugged into grounded outlet receptacles. (Avoid using AC cheater plugs. Lifting of the power cord ground may increase RF emission levels and may also present a lethal shock hazard to the user.)

If you need additional help, consult your dealer or ask for assistance from the manufacturer. Customer service information may be found in the In Case of Difficulty section of the manual. You also may find the following booklet helpful: How to Identify and Resolve Radio-TV Interference Problems, which is available from the U.S. Government Printing Office, Washington, D.C. 20402 (Stock No. 004-000-000345-4).

### Registration

To receive the full benefits of your Warranty, complete and mail the accompanying Registration Card. Record the model, series, and serial number of your equipment below. Also record the date purchased. Refer to this information in any communication you have with Zenith Data Systems regarding this equipment.

Model \_\_\_\_\_ Series \_\_\_\_\_

Serial Number \_\_\_\_\_ Date Purchased \_\_\_\_\_

---

# Z-170 PC Portable Computer

Owner's Manual

### **Limited Rights Legend**

Contractor is Zenith Data Systems Corporation of St. Joseph, Michigan 49085. The entire document is subject to Limited Rights data provisions.

### **Trademarks and Copyright**

IBM, IBM PC, and PC-DOS are registered trademarks of the International Business Machines Corporation.

MS-DOS is a registered trademark of Microsoft.

Z-100 and Z-DOS are trademarks of Zenith Data Systems Corporation.

Copyright © 1985 by Zenith Data Systems Corporation

Printed in the United States of America

Zenith Data Systems Corporation

St. Joseph, Michigan 49085

# Contents

<b>Introduction</b> .....	1
<b>Operation</b> .....	3
General Care and Handling .....	3
Opening and Closing the Computer .....	4
Shoulder Strap Removal .....	5
Getting to Know the Computer .....	6
Front View .....	6
Right Side View .....	7
Rear Panel View .....	8
Left Side View .....	10
AC Adapter .....	11
Memory: The Three Types .....	12
Disks .....	13
General .....	13
Types of Disks .....	15
Initial Boot-Up .....	15
Disk Loading .....	16
Entering the Time and Date Automatically .....	18
MS-DOS Back-Up Copy .....	19
Formatting .....	19
Keeping Track of Disk Space .....	20
Naming Files .....	20
Keyboard .....	21
Overview .....	21
Icons .....	23
Clock/Calendar Icon .....	23
Phone Icon .....	23
Disk Icon .....	23
Calculator Icon .....	24
Function Keys .....	25
Alphanumeric Keys .....	26
Modifier Keys .....	27
Program Keys .....	28
Special Keys .....	30
Calculator .....	32
Keys .....	32
Display Symbols .....	35
Memory Value .....	35
Mathematical Examples .....	36
World Map Display .....	40
Calendar and Clock .....	40

# Contents

---

Setup Menu .....	42
Clock .....	43
Display .....	45
Start-Up .....	45
Printer/Serial Port .....	46
Modem .....	48
Internal Modem .....	48
Appointment Calendar .....	49
Connecting Devices to Your Computer .....	52
General .....	52
Connector Pinouts .....	54
Printers .....	56
Parallel Printer .....	56
Serial Printer .....	56
<b>In Case of Difficulty</b> .....	59
Service and Warranty .....	59
Automatic Tests at Power-Up .....	60
Additional Troubleshooting Hints .....	62
<b>Specifications</b> .....	63
<b>Appendix A, Options</b> .....	A.1
General Disassembly .....	A.1
Battery Pack Installation .....	A.3
Internal Color Video Card Installation .....	A.5
256K Dynamic RAM Chips Installation .....	A.6
300/1200 Baud Modem Installation .....	A.8
300/1200 Baud Modem Operation .....	A.11
General .....	A.11
Directory Display .....	A.12
Update Display .....	A.15
Backing Up the Phone Directory .....	A.18
Modem "Hands-On" Experience .....	A.21
<b>Appendix B, Software Summaries</b> .....	B.1
MS-DOS .....	B.1
Control Functions .....	B.2
Syntax Notations .....	B.3
Commands .....	B.4
ASCII Codes .....	B.12
Z-170 PC Keyboard Codes .....	B.19
Cross-Reference Chart (Z-100 PC Series/Z-170 PC Series) .....	B.23
Hayes Auto Dialing Protocol Summary .....	B.24
<b>Index</b> .....	I.1

## Introduction

Congratulations on your purchase of Zenith Data System's new state-of-the-art personal computer, the Z-170 PC Portable Computer.

Your new lightweight, briefcase-size computer is truly portable, weighing less than comparable models, and conveniently transportable with its over-the-shoulder strap. It's the right size to carry between home and office and small enough for carry-on luggage on the airlines.

You can use your new computer as a self-contained unit or as part of a large computer network. It can handle a wide variety of business and personal computing needs, and combined with Zenith Data Systems software, your personal computer can provide practical and affordable solutions to many business computing problems. Some of the many applications include data processing, telecommunications, transmittal of vital information from an outside location to an office mainframe, word processing, and order entry.

This Owner's Manual will acquaint you with your new computer and explain the many features and how to use them.







# Operation

In this section, we'll cover some basic points in caring for your computer. We'll get to know the computer by taking a look at the controls, switches, inputs, disks, and disk drives. We'll take a look at the keyboard and discuss the keys and their functions. Then we'll cover some of the operating procedures.

## General Care and Handling

- Keep the portable computer closed when it is not in use and be sure the power switch is off.
- Don't expose the computer to excessive amounts of direct sunlight or extreme temperatures.
- When moving the computer, use the cardboard shipping inserts that came with the drives to keep the drive heads from bumping into each other. Or, as an alternative, a spare disk will serve the same purpose.
- Never connect or disconnect external devices, such as printers and modems, to the computer while the power switch is on.
- Open the disk drive doors **before** turning off or unplugging the portable computer. Leave the doors open while turning the portable computer back on. This eliminates the possibility of damage to the disks resulting from a voltage surge when the computer is turned off or on.

## Opening and Closing the Computer

To open the computer:

Press the front edges of the keyboard latches as shown. Gently swing the keyboard down.

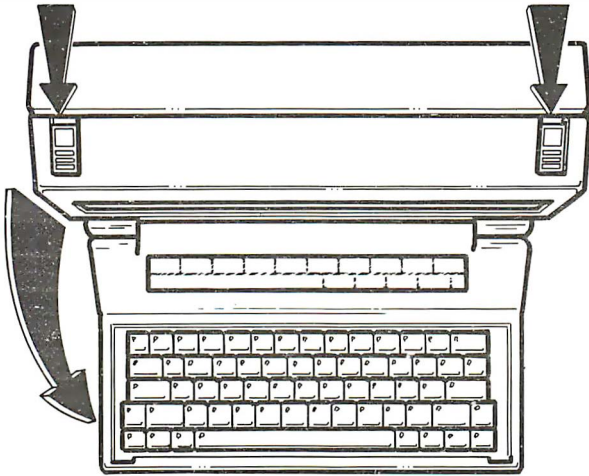

To close:

Swing the keyboard up. Hold it in its closed position and slide the latches forward until they click into place.

## Shoulder Strap Removal

The cloth shoulder strap is convenient for transporting the computer, but you may want to remove the strap when you use the computer at one location for a while. It's also easier to connect peripherals such as a printer or modem when the shoulder strap is removed.

To remove the shoulder strap:

Pull up on the latch on each side of the case as shown. Unhook the shoulder strap.

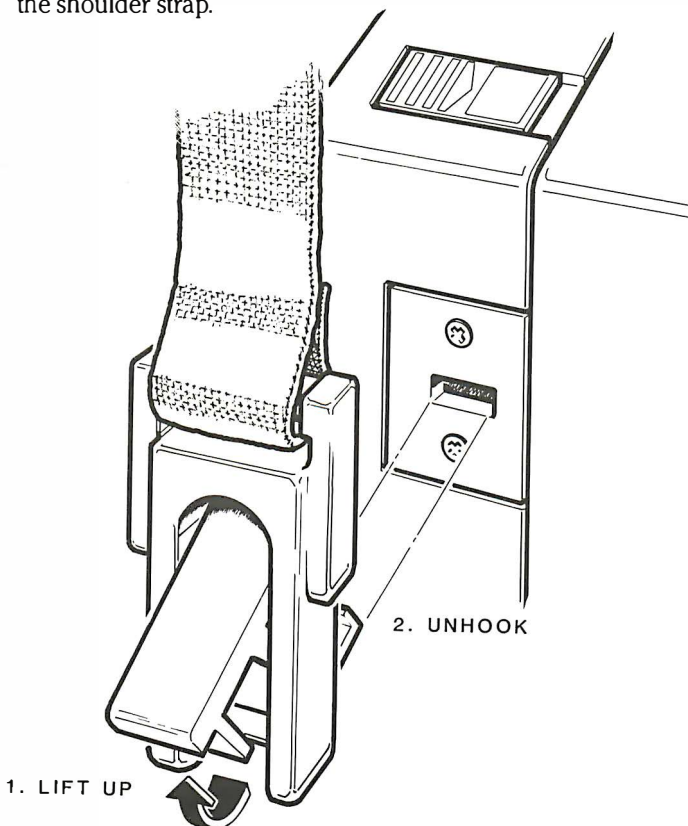

To replace:

Pull up on the latch, insert the hooked portion into the opening on the side of the computer, then release. The strap is now reinstalled.

## Getting to Know the Computer

### Front View

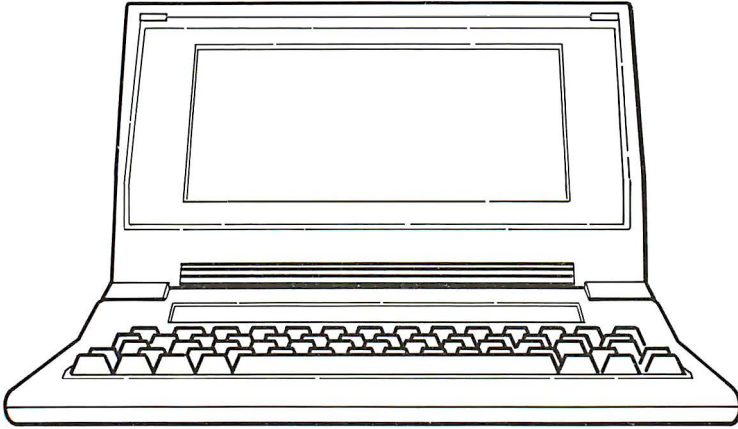

**Screen** — Your portable computer has a 25-line electroluminescent and liquid crystal display (LCD) that's compatible with the IBM PC™ color graphics adapter in text and graphics modes.

The display has a back light, which you adjust to control the display intensity. When the computer is on and a key has not been pressed for 10 minutes, the back light automatically goes off, thus prolonging the life of the internal battery. Pressing any key will turn the back light on again.

**Cursor** — When you're using MS-DOS™ (the operating system), you'll notice a rectangular block on the screen. This is the cursor and it marks the position where your typed entries will appear. You'll also see the cursor on the screen when you run most programs, and when you type, and position text. It also has other duties with some of the portable's built-in functions.

## Right Side View

On the right side you will find two floppy disk drives which are 5-1/4", double-sided, double-density drives. They have nine sectors/track, 362 kilobytes of storage, and are IBM-PC standard format.

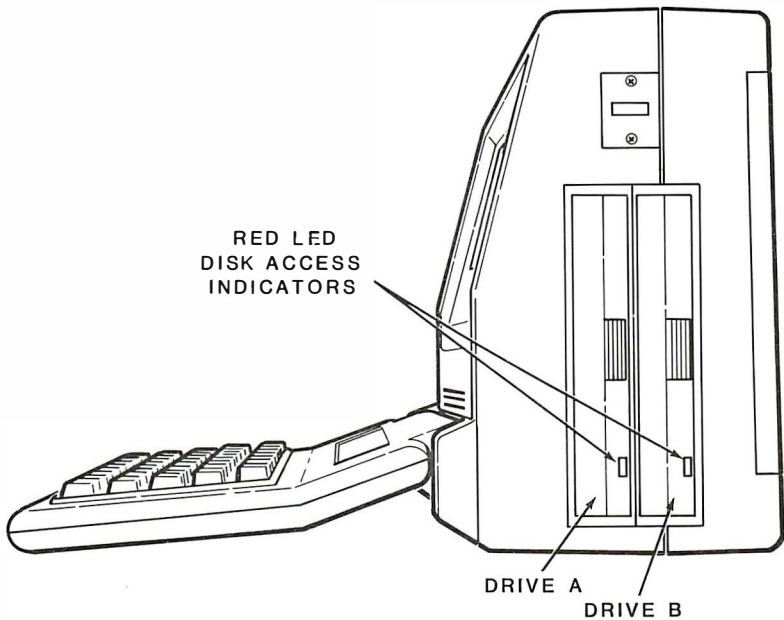

The drive closer to the keyboard is drive A and the rear drive is drive B. Each has a red LED disk access indicator which lights when the computer is attempting to read from or write to the disk. Do not open the door when the red LED is lit.

When the doors on these drives are closed, they completely cover the drive slots, which protects against dirt and dust. They are spring-activated and snap shut flush with the case.

## Rear Panel View

The rear panel contains the device connectors. Some of the connectors are for optional accessories. They're listed here and the installation of these accessories is covered in Appendix A.

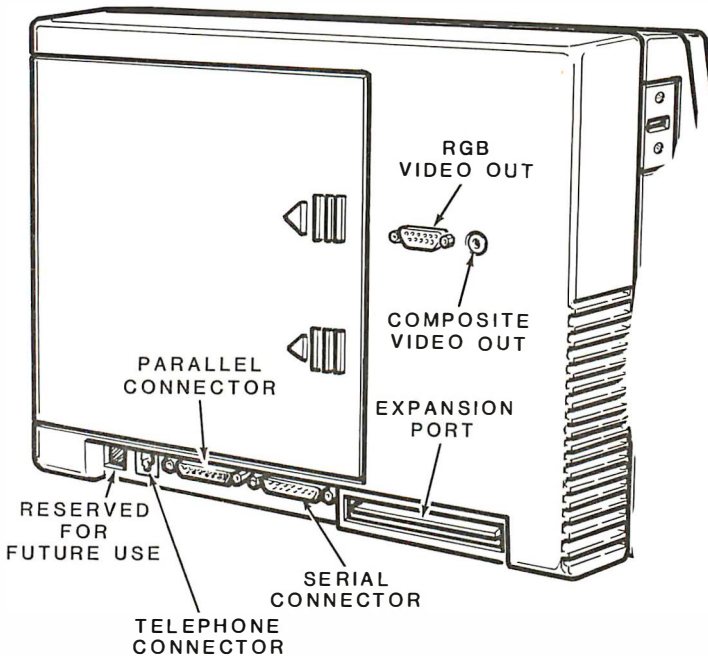

**Telephone Connector (RJ-11C)** — This jack is used for the internal 300/1200 baud, Hayes-compatible modem and for a wide variety of external modems using a serial RS-232C port.

**Parallel Connector** — This connector is a Centronics-type parallel output port for a printer or other device that uses parallel input signals.

**Serial Connector** — This is an RS-232C DTE (Data Terminal Equipment) port used for connecting serial printers, external modems, and other serial devices. It also can be used to connect the computer as a terminal for another computer.

**RGB Video Out** — A high-resolution color monitor that uses red, green, blue, and intensity signals (RGBI) can be connected to the computer using this 9-pin D connector. **NOTE:** This requires installation of the optional Internal Color Video Card.

**Composite Video Out** — Provides connection for an external monochrome (black and white, black and green, or black and amber) monitor with a video output signal if you have installed the Internal Color Video Card. Do not use a standard television receiver for this purpose; it is not designed to display the information required for word processing or accounting applications. **NOTE:** This requires installation of the optional Internal Color Video Card.

**Expansion Port** — For connection to the optional Color Video Card and to an expansion chassis.

## Left Side View

Here's where you'll find the controls you will be using often.

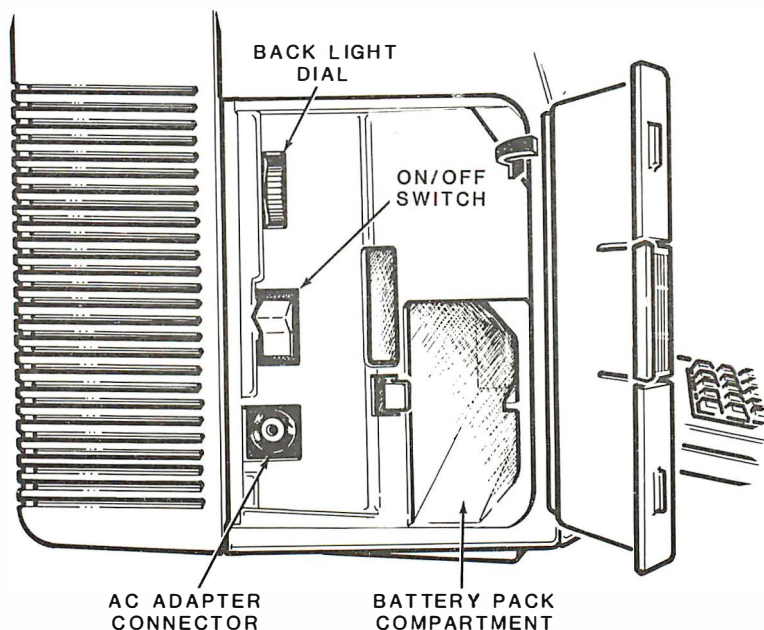

**Back Light Dial** — This dial adjusts the intensity of light behind the display to suit your environment and preference. It's also used as a contrast control to improve the visibility of the display screen.

**On/Off Switch** — Push up to turn on the computer; push down to turn it off. When both the AC adapter and battery pack are installed, the batteries will be charged, regardless of the position of this switch.

**Battery Pack Compartment** — The optional battery pack is installed in this compartment. (Appendix A tells you how to install the battery pack.)

**AC Adapter Connector** — For AC current operation, plug the adapter into this connector. Be sure the plug is inserted all the way.



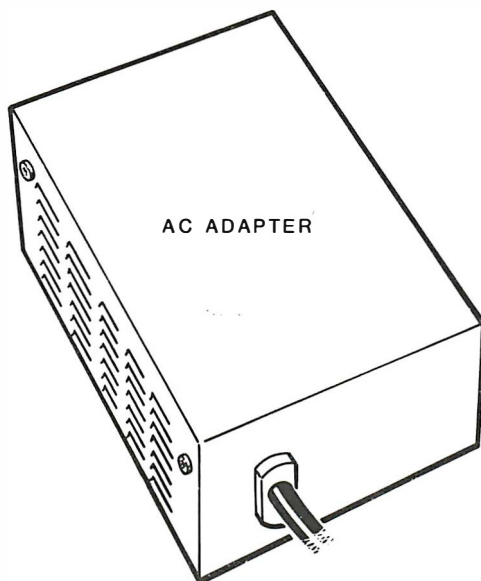

## AC Adapter

The AC adapter is shipped from the factory to operate at 120 VAC, 50/60 hertz. Have a qualified service technician change this setting if you wish to operate the AC adapter at 240 VAC, 50/60 hertz.

**WARNING:** When using the AC adapter, always connect the adapter to the computer, and then connect the adapter to an AC power outlet. When you're not using the adapter to run the computer or charge the battery pack, disconnect the adapter from the power outlet, and then disconnect it from the computer.

Do not disconnect the AC adapter while running a program, even if you have a fully-charged optional battery pack.

## Memory: The Three Types

Your computer comes with three types of memory chips. They differ in what they're for, how they store information, and how much of each is included.

**ROM** — Read-Only Memory implies that the computer can read the contents of these chips, but can't write anything new into them. ROM chips are permanently "burned" to hold information that the computer needs all the time. Specifically, they store the instructions for booting the computer, showing the World Map Display, running the calculator, appointment calendar, and the phone directory.

**Dynamic RAM** — This type of Random Access Memory holds information that changes very rapidly. When you run WordStar, the WordStar programs are copied from the program disk into RAM. A document you type is also stored in RAM. When power is lost, or when you reset your computer, everything in RAM is lost. That is why data and programs are always stored on disks.

**Non-Volatile RAM** — NVRAM is a special type of RAM that is kept intact with a small battery built into your computer. The contents of NVRAM are **not** lost with a power interruption or when you reset your computer. The NVRAM mainly stores the phone directory and your appointment calendar.

## Disks

### General

Your computer uses soft-sectored 5-1/4", double-sided, double-density floppy disks. Let's take a look at some basic items about these disks.

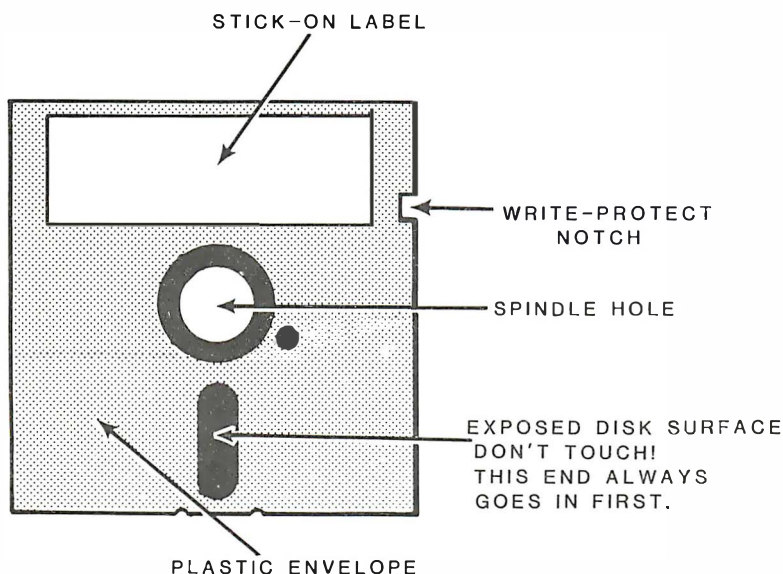

**Stick-On Label** — Write the file names on this label so you can identify the disk. It's best to write on the label before putting it on the disk. If the label's already on the disk, be sure to use a felt-tip pen. Labels go on the smooth side of the disk — the side without the seams. When inserting the disk into the computer, the label side faces the front of the computer.

**Write-Protect Notch** — Most disks have a small notch cut along their edge. This is called the write-protect notch. When the notch is uncovered, you can put new files on the disk, or change information on it. When it's covered with a write-protect tab, all you can do is read information off the disk; you can't change or erase anything.

## Operation

---

You should always write-protect your most valuable disks. If the information changes frequently, make routine backup copies of the disks with the DISKCOPY program on your MS-DOS disk and write-protect them. (Refer to page 19).

Write-protect tabs usually are supplied with blank disks when you buy them. The only disks you'll encounter without the notches are some software master disks. This keeps the masters from being changed in any way.

**Plastic Envelope** — This is a permanent part of the disk. Don't try to unwrap it.

Here are some of the "do's and don'ts" of caring for disks.

- DO:**
- Format all new disks.
  - Store them in their paper envelopes.
  - Keep them clean and dry.
  - Make backup copies of valuable disks.
  - Put write-protect tabs on valuable disks.
  - Label them with stick-on labels and a felt-tip pen.
  - Remove disks **before** turning the computer off.
  - Keep disks away from heat or direct sunlight.
  - Keep disks away from dust, oil, water, etc.
- DON'T:**
- Reformat valuable disks.
  - Use ballpoint pens or pencils when writing on labels.
  - Expose them to magnetism of any sort.
  - Touch the exposed surface of the disk.
  - Use paper clips on disks.

## Types of Disks

There are three categories of disks: system, program, and data. A disk can actually hold system files, programs, and data all at once; but for convenience, it's best to divide your "software" into these three categories.

**System Disk** — The MS-DOS system disk is special for two reasons: First, you can boot from it when you turn the computer on. Second, it contains the MS-DOS "housekeeping" programs like FORMAT and DISK-COPY.

**Program Disks** — These disks are application programs like SuperCalc®. It contains all the files needed to run the program. When you're working with program disks you normally have another disk called a data disk which stores the words and numbers you're manipulating with the programs.

**Data Disks** — These disks are your workspace, the place where you store the data generated when you use an application program.

## Initial Boot-Up

Your computer is designed to operate with MS-DOS (MicroSoft Disk Operating System). This is a program that lets you do certain tasks, such as organize the disk, copy information from one disk to another, enter the time and date, and load other programs.

MS-DOS was prepared for Zenith Data Systems Portable Personal Computer by Microsoft. It is compatible with Z-DOS™, the operating system for the Zenith Data Systems Z-100 PC Series Computers, and PC-DOS™, the operating system of the IBM Personal Computer. It is supplied on disks and must be loaded into your computer.

## Operation

---

### Disk Loading

Your computer was shipped with protective cardboard inserts in the drives. Be sure these are removed before inserting a disk into the computer. (Save these inserts to use when you transport the computer.)

If you are using your computer with the AC adapter:

Connect the AC adapter to your computer and then connect the AC adapter power line cord to an outlet. (If you are using the optional battery pack, refer to Appendix A for installation instructions.)

Turn on the computer with the On/Off switch.

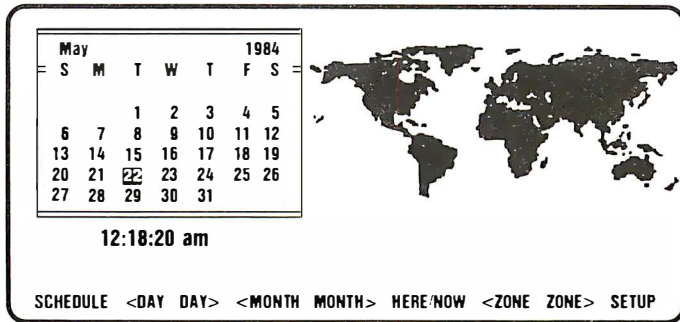

You will see a brief message, "Testing Memory," and the World Map will be displayed. It may be necessary to adjust the Back Light Dial for better viewing.

To “load” the disk operating system, take the MS-DOS Distribution Disk I and insert it into drive A as follows:

Press the middle of the drive door. The spring-loaded door will pop open.

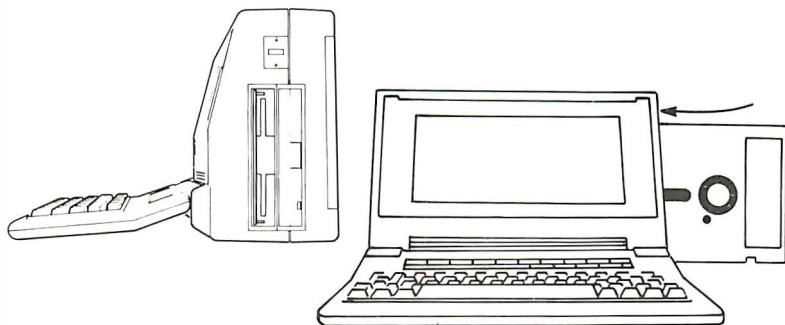

Insert the disk into drive A with the label side at the end, facing you, as shown. Slide the disk all the way in until it latches into place.

If the disk does not slide into the drive easily, check the label on the disk. Make sure it's not interfering.

After you've “loaded” the MS-DOS disk:

Carefully close the door. Make sure it snaps shut. This engages the drive hub into the disk so the drive can operate.

Press the Disk Icon (see page 23).

You should see the following message on the screen:

Booting...

MS-DOS version 2.XX

Copyright 1981, 82, 83, 84 Microsoft Corp.

Current date is XX:XX:19XX

Enter new date:

Current time is: XX:XX:XX

Enter new time:

## Operation

---

Refer to the figure below and enter the new date and press RETURN. Then enter the time and press RETURN.

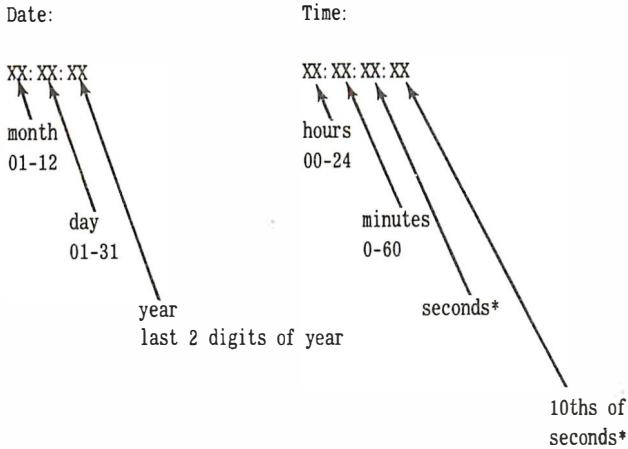

\*optional entry

The `A>` prompt should now appear, indicating that you've loaded MS-DOS into your computer.

## Entering the Time and Date Automatically

Your computer contains a "real time" clock that keeps track of both the date and time automatically using the NVRAM (non-volatile RAM) memory. This information can be automatically entered when you boot up MS-DOS; so instead of you having to enter the time and date, the computer will do it for you. To use this feature, you must create an `AUTOEXEC.BAT` file, copy a program called `DATETIME.COM` on your Demo (demonstration) disk onto your system disk and place the command `DATETIME` into the `AUTOEXEC.BAT` file.

The procedure for creating the `AUTOEXEC.BAT` file (batch file) and for placing the command `DATETIME` program into the `AUTOEXEC.BAT` file can be found in your MS-DOS documentation.



## MS-DOS Backup Copy

A backup copy might easily be called an insurance copy. It is a duplicate of a disk. Sometimes accidents happen — a disk is ruined or lost. If you have a backup disk, you won't be losing valuable information. To make a backup copy of MS-DOS to use as a "working copy," you'll need a blank 5-1/4", soft-sectored, double-sided, double-density floppy disk. Label the disk, "MS-DOS System Disk." (Write on the label before you put it on the disk. That way you'll avoid damaging the disk by writing on it.)

Use the MS-DOS disk that came with your computer to make a working copy. If it isn't already in drive A, place it there now.

Proceed as follows:

1. With the MS-DOS disk in drive A, and the A> prompt on the screen, insert the blank disk you labeled "MS-DOS System Disk" in drive B and type **DISKCOPY A: B:** and then press **RETURN**.
2. The screen will display a message asking you for the destination drive. Type **B**. You will then be instructed to place the source disk in A and the destination disk in B. You already have done this, so press **RETURN**.
3. You will now see "Formatting...", then "Copying...". Then you will be asked if you wish to copy another disk. Type **N** for no. The A> prompt will return.

And that's all there is to it. The MS-DOS master disk has been copied onto the disk in drive B. Remove the MS-DOS master disk from drive A and store it in a safe place. You'll now use your "working" copy when you want to use MS-DOS.

## Formatting

Unless you use DISKCOPY to duplicate a disk, you have to format new disks before you use them. (DISKCOPY automatically formats the disks.) Formatting is the "organization" of your disk so it can hold your "files" of information. This information may be data, programs, or the disk operating system (DOS).

A disk that has been previously used can be reformatted, but remember: **Formatting a disk erases everything on it!** So be careful. Make sure you do not reformat a valuable disk by accident.

## Keeping Track of Disk Space

It's a good idea to keep track of the available space on your disk. Otherwise you may labor for hours on a document, only to find there isn't room to save the information on the disk.

To determine how much space you have, when the prompt for the appropriate drive comes on the screen, type **DIR A:** and press **RETURN** (or **DIR B:** if the disk is in drive B). The bottom line of the resulting directory will tell you how many bytes are left for storing new data.

Each disk holds about 360,000 bytes (360K) of programs and data. A full page of single-spaced text takes about 3 kilobytes. Some word processing programs maintain temporary disk files that raise the need for available space to about 6 kilobytes per page.

## Naming Files

Whenever you write a new memo, create a graphics design, or make a spreadsheet, you're generating a new data file. When choosing a name for a file, it's best to describe the file with a short title.

- Files need a first name from 1 to 8 characters. If you need additional characters, add a period, then you can add 3 additional characters. You can use these additional characters even if you don't use all 8 characters before the period.
- File names can include most characters on the keyboard, but certain punctuation marks cannot be used since they have special meanings in the MS-DOS program. (Check your MS-DOS documentation for the exceptions.)
- All files must have a unique name. It must differ from all others on the disk by at least one character.

## Keyboard

### Overview

This section of the manual will describe the general nature of the keyboard, which is designed to duplicate the functions of Z-100 PC keyboards. The layout is as similar as possible within the design constraints of a lap-model computer. There are keystrokes and sequences of keystrokes that are unique to this computer. The following chart compares the keystrokes of the Z-100 PC Keyboards with the Z-170 PC Keystrokes.

#### Cross-Reference Chart

Z-100 PC Computer Series	Z-170 Portable Computer
Keystrokes Required	Actual Keys Typed
Unshifted/Left Arrow	Left Arrow
Unshifted/Right Arrow	Right Arrow
Unshifted/Up Arrow	Up Arrow
Unshifted/Down Arrow	Down Arrow
Unshifted/Num Lock	Num Lock
Unshifted/Delete	Delete
Unshifted/Home	Right Shift + Home
Unshifted/End	Right Shift + End
Unshifted/Pg Up	Right Shift + Pg Up
Unshifted/Pg Dn	Right Shift + Pg Dn
Unshifted/Scroll Lock	Right Shift + Scroll Lock
Unshifted/Insert	Right Shift + Insert
Shift/Left Arrow	Left Shift + Left Arrow
Shift/Right Arrow	Left Shift + Right Arrow
Shift/Up Arrow	Left Shift + Up Arrow
Shift/Down Arrow	Left Shift + Down Arrow
Shift/Num Lock	Left Shift + Num Lock
Shift/Delete	Left Shift + Delete
Shift/Home	Left Shift + Right Shift + Home
Shift/End	Left Shift + Right Shift + End
Shift/Pg Up	Left Shift + Right Shift + Pg Up
Shift/Pg Dn	Left Shift + Right Shift + Pg Dn
Shift/Scroll Lock	Left Shift + Right Shift + Scroll Lock
Shift/Insert	Left Shift + Right Shift + Insert

## Operation

The previous chart shows that the left Shift key performs the standard shift functions; while the right Shift key, when used with the dual function keys (Arrow Keys, Num Lock, and Delete) selects the upper functions of those keys. That way, both the shifted and unshifted functions of those keys can be generated.

Because of the multitude of tasks your computer can do, some keys perform a variety of tasks. There are also a few keys that are unique to this computer.

The computer keyboard has two major blocks of keys: the function keys/Icon block and the typewriter block. (Icon is a symbol that represents an object or concept.) The typewriter block contains alphanumeric keys, modifier keys, program keys, and other special keys.

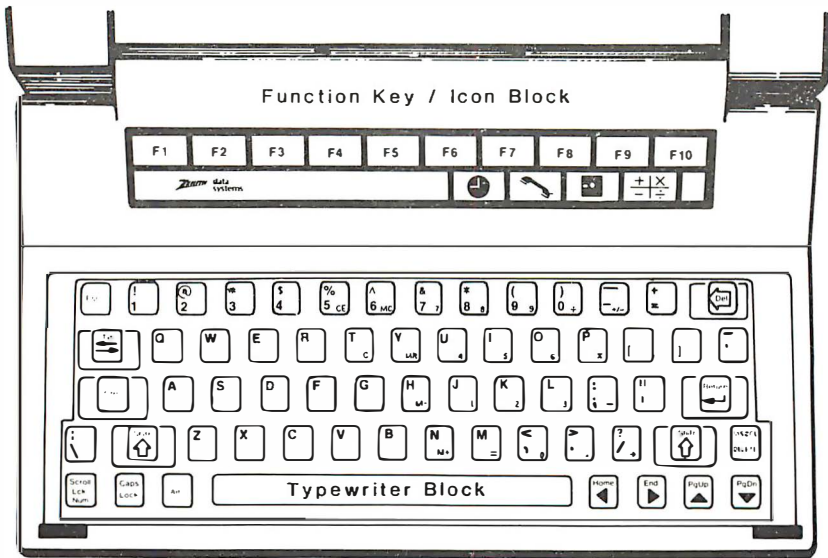

Every key on the keyboard has auto-repeat; that is, it repeats itself as long as you hold it down. This is most useful with keys that move the cursor, like DEL, RETURN, the space bar, and the arrow keys.

## Icons



The icon keys initiate the functions that make this computer much more than a basic lap-top computer. Most of the icon functions are available without booting MS-DOS, in other words, no disks are involved.

Some of the icons have two different meanings. This depends on what you're doing when you press them. See the text that follows for details.

### Clock/Calendar Icon



Pressing this key takes you to "home" base, the World Map display. From there you can change your set-up options or check the time in another area of the country or a foreign time zone.

### Phone Icon



When this icon is pressed, the computer will dial a number for you from its directory or make a call to a database service. It can also turn the computer into a "dumb terminal" for use with a nearby computer.

### Disk Icon



This icon has a couple of effects. If the World Map display appears when you first turn on the computer, pressing the Disk Icon will boot MS-DOS. This is the normal startup routine; an MS-DOS system disk or other "bootable" disk should be in drive A when you press the Disk Icon.

Another common use of the Disk Icon is to get back to a program after interrupting it by pressing some other icon. For instance, suppose you are running WordStar and you press the Calculator Icon to do some figuring. Pressing the Disk Icon will return you to WordStar. The same is true if you interrupt a program to use a modem; pressing the Disk Icon will return you to the original program.

### Calculator Icon

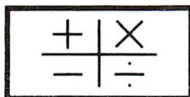

Pressing this icon activates the four-function calculator. A calculator “window” appears on the left side of the display (as viewed from the front). If you’re running a business program, its display stays on the rest of the screen, but you cannot continue working that program until you exit from the calculator function by pressing the Disk Icon.

You can shift the calculator to the right side of the screen and back again by pressing the Calculator Icon a second and third time.

## Function Keys

The function keys make up the row above the icons. They are labeled F1 through F10.

F1	F2	F3	F4	F5	F6	F7	F8	F9	F10
----	----	----	----	----	----	----	----	----	-----

Function keys are used for special purposes by some programs. In addition, when the World Map display is active, the computer also uses these keys to perform tasks such as changing the active calendar date, moving the Time Zone display, and calling up the Setup Menu. The meanings appear on the bottom line of the display over the function keys.

Some of the function keys are also used in conjunction with the calculator and modem functions. Their meanings also appear on the bottom line of the display.

The function keys also have special editing powers when you're at the A> or B> prompt; you can reuse all or part of a previously-entered command. (Refer to the MS-DOS User's Guide, Commands section.)

## Alphanumeric Keys

These are the letter, number, and punctuation mark keys that are similar to their typewriter counterparts.

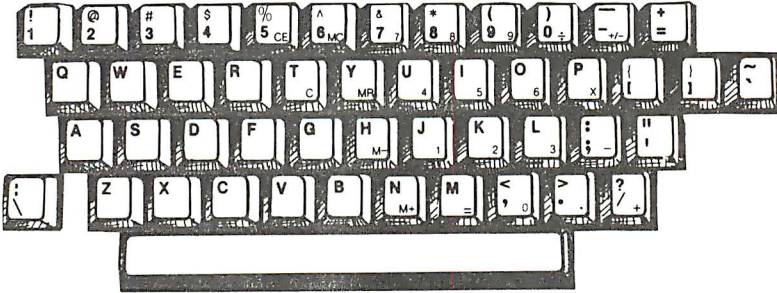

Some of these keys also have secondary meanings. Those with small blue numbers are used as part of the calculator keypad after the Calculator Icon has been pressed. They can also be used for typing numbers while running a program, like a spreadsheet. This is a function of Numeric Mode.

A few of the alphanumeric keys have unique computer uses. Specifically:



**Caps Lock** — This is almost the same as a typewriter shift lock key: press it once to begin typing capitals, press it again stop typing capitals. The difference is it only affects letter keys. With the Caps Lock active, the numbers in the upper row stay numbers; you still need to press either the right or left the Shift key to change them into the special symbols (!, @, #, etc.).



**Return** — Returns the cursor to the left side of the display (software usually adds a line feed as well). Also, pressing the Return key after data or instructions have been entered, tells the computer to process them.



**Delete** — Moves the cursor back to the left (backspaces).



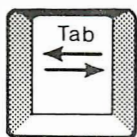

**Tab/Back Tab** — Moves the cursor to the next tab setting.

## Modifier Keys

The Shift, Ctrl, and Alt keys are called “modifier keys” because they modify, or change, the meaning of some other key. The modifier keys are **always used in conjunction with another key**. They don't do anything when used alone.

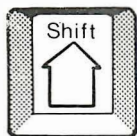

**Shift** — There are two Shift keys on the keyboard; a right Shift key and a left Shift key. Normally, when the Shift key is pressed, you get capital letters, symbols, and extra punctuation marks. However, if the Caps Lock key is also active, pressing the Shift key will generate lowercase letters.

The left and right Shift keys also interact with the Scroll Lock/Num key to change its meaning from Numeric Mode (On/Off) to Scroll Lock. The same is true for the Delete/Insert key (to be covered later). When the Delete/Insert key is pressed in conjunction with the right Shift key, it becomes Insert Mode (On/Off).

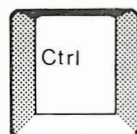

**Ctrl (Control)** — This key is used as one of the main keys for entering programs. Customarily, you press and hold the Ctrl key, and then press another key. The Ctrl key is often symbolized by a caret (^). For instance, if you see ^ K, you would press and hold the Ctrl key and then the K.

The Ctrl key is also used to modify several of the computer's keys to activate the meanings printed on the front edges of those keys. For example, pressing the Ctrl and Scroll Lock/Num key activates the Pause function for temporarily freezing the display.

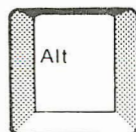

**Alt (Alternate)** — The Alternate key is almost identical in practice to the Ctrl key. It is used in the same way for entering commands, but it is much less frequently encountered.

## Program Keys

Basically, “program keys” have meaning only to business programs that are designed specifically to use them. However, these type of programs, such as spreadsheets, are becoming quite common. Refer to the program documentation to see if and how it uses the program keys.

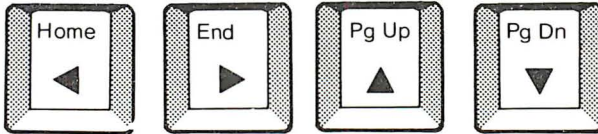

**Arrow Keys** — These are also called “cursor keys.” The arrows on these four keys indicate the direction the cursor will move when you press them. With WordStar, you can either enter Ctrl-key commands to move the cursor for typing and positioning text, or you can get the same effect much more simply by using these keys.

With many spreadsheets, these keys move the active cell in the direction they point. Other programs use the arrow keys in similar ways.

Each of the arrow keys has a second meaning when used together with the right Shift key. The meaning appears at the top of the key. (Again, for these keys to do what they say they’ll do, the program you’re using must have been designed with these keys in mind.)

**Home** — When using WordStar, pressing and holding the right Shift key while pressing Home will move the cursor to the upper-left corner of the screen. This is equivalent to the ^QE command. With spreadsheet programs, Home usually puts the active cell indicator in the upper-left corner of the spreadsheet (cell A1).

**End** — When pressed with the right Shift key, it will put the cursor in the lower-left corner or the most remote cell on a spreadsheet.

**Pg Up and Pg Dn** — These are the “page up” and “page down” keys. They move the cursor some set number of lines upward or downward.



**Scroll Lock/Num** — This key has the Scroll Lock effect when used with the right Shift key and the Num effect when pressed alone.

**Scroll Lock:** This is used by some spreadsheets to keep the cursor on the same screen line, while moving the whole spreadsheet, instead of the cursor. To get this effect, Shift and Scroll Lock/Num are pressed simultaneously. Scroll Lock can be canceled by pressing Shift and Scroll Lock a second time.

**Num:** This turns the block of keys with blue numbers on them from letters into numbers (Numeric mode). It also lets the keys with the blue plus and minus signs display their symbols. They will then do exactly the same thing as the regular number keys in the top row. This is a convenience feature with spreadsheets and other situations where you're typing long lists of numbers. This is the computer's way of providing a numeric keypad.

The other blue-letter keys such as the CE, M+, x, etc., retain their normal meanings. They change meaning only when you activate the Calculator mode.

If you want to type letters that have been replaced by the Numeric mode. Cancel Numeric mode by pressing Scroll Lock/Num a second time.



**Insert and Delete** — Delete is the regular meaning of this key; it means Insert when used with right Shift.

**Insert:** To exit from the Insert mode, press and hold the right Shift key. Then press the Insert key. To turn it back on, press and hold the right Shift key, then press Insert again. The Insert mode determines whether text you type will push existing text aside to make room (on), or simply type over and replace existing text (off). Insert is also part of a command sequence that inserts a new blank row or column into an existing spreadsheet.

**Delete:** Backspaces, while erasing whatever the cursor crosses. Its special purpose is to reset the computer when used simultaneously with the Ctrl and Alt keys.

## Special Keys

Generally, these are keys with additional labels printed on their front edges. In all cases, this front-edge meaning is activated by pressing the special key simultaneously with the Ctrl key.



**Pause** — When pressed at the same time as the Ctrl key, this command freezes the display of text on the screen.



**Prt Sc (Print Screen)** — When pressed simultaneously with the Ctrl key, this key sends whatever is onscreen to the printer. Your printer must be on, online, and have paper ready or the computer will pause until the printer becomes ready.

Typically, you would use Prt Sc to get a hard copy of the onscreen text, such as a list of files for a DIR (Directory) command.

The primary time to use this feature is when you run MS-DOS commands like DIR and TYPE, or if you're communicating with a modem, and want a copy of one screenful of information. Prt Sc sends out a full 25 lines of data.



**Prt On (Print On)** — When pressed at the same time as the Ctrl key, this MS-DOS function sends everything that's going to the screen to the printer as well. The printer has to be on, online, and have paper ready.

Once you enter the command, Print On stays in effect until you enter the same command a second time, or you reset the computer.



**Break** — The Break command, when used simultaneously with the Ctrl key, is used to stop certain programs as they're running. For example, if you begin a Diskcopy routine only to realize that you can't find the disk you want to copy, enter Break to quit. The A> prompt will return. Break is useful in stopping Type commands when you've seen enough. Generally, it is used with MS-DOS commands and not business programs.

Most business programs don't respond to Break keystrokes. This is a safeguard to prevent you from accidentally leaving the program before you save the data.

## Operation

---

### Calculator

Your computer includes a four-function, 16-digit calculator that may be used while an application program is running.

To activate the calculator at any time, simply press the Calculator Icon. To return to a program from the calculator, press the Disk Icon. Otherwise, press the Clock Icon to return to the World Map.

The result of a calculation can be stored in a special Memory Value that can later be transferred to another program, such as a word processor or data base.

### Keys

Shown below are the keys which make up the calculator keypad. They are identified by the small blue symbol in the lower right-hand portion of the keypad.

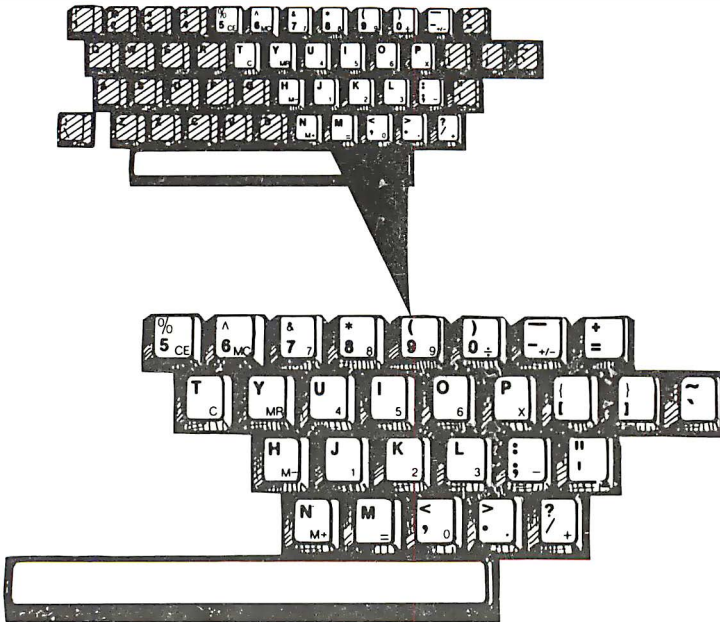

Following is a brief explanation of each key.

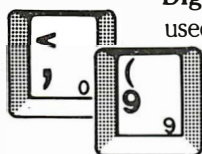

**Digit keys, 0 through 9** — The space bar can also be used as a zero key.

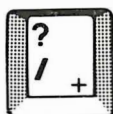

**Plus key** — For addition.



**Minus key** — For subtraction.

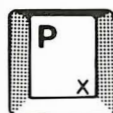

**Multiply key** — For multiplication.

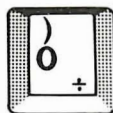

**Divide key** — For division.

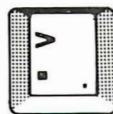

**Decimal point key** — For the placement of a decimal point.



**Equal key** — For obtaining the results of operations. The result may be used in subsequent calculations. This key is also used for repeated multiplication/division and repeated addition/subtraction.

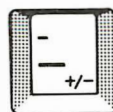

**Change Sign key** — Changes a positive number to a negative number and vice versa. *The small blue +/- sign may not be shown on your computer, but it will still work.*

Operation

---



**Memory Plus key** — For adding an entry to the Memory Value. Can also be used instead of the equal key to finish a calculation while adding the result to the Memory Value.



**Memory Minus key** — For subtracting an entry from the Memory Value. Can also be used instead of the equal key to finish a calculation while subtracting the result from the Memory Value.



**Memory Recall key** — For including the Memory Value in calculations.



**Memory Clear key** — For resetting the Memory Value to zero.

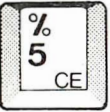

**Clear Entry key** — For correcting erroneous entries and error conditions such as overflow.

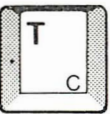

**Clear key** — Empties the display, total, and constant registers, but **not** the Memory Value.



## Display Symbols

The calculator displays standard mathematical symbols: +, −, ×, ÷, and =. The only symbols that may be unique are: +M, −M, ×M, ÷M which mean the Memory Recall (MR key) was used to bring the Memory Value into a calculation. MV means “the current Memory Value is ...”. \*ERROR\* signifies that an error has occurred. You may have typed or calculated a number longer than 16 digits or entered a sequence of keystrokes that the computer can't understand. Press the CE key to clear the error condition.

## Memory Value

The Memory Value is shown in the lower portion of the calculator window and is indicated by the characters **MV**. The memory value is kept in NVRAM, the battery-supported RAM memory. Once established, a number in the Memory Value stays there even if power is interrupted or you run other programs. Initially it contains zero. You can add to it by pressing **M+** after typing a number or calculation. You can subtract from it the same way by pressing **M−**. You can use the Memory Value in calculations by pressing **MR** (for Memory Recall). You reset it to zero by pressing **MC** (Memory Clear).

The Memory Value can be transferred to other programs. For instance, suppose you're in a word processing program and you need to add a list of figures, you press the Calculator Icon. You can now perform your calculations and place them in the Memory Value. To return to the word processing program, you press the Disk Icon. When your cursor is at the point where you want the value to be entered, press and hold the **ALT** key while pressing the Calculator Icon. The Memory Value will appear at the cursor.

# Operation

---

## Mathematical Examples

The following examples illustrate the key sequences involved in a variety of common calculations.

<u>TYPE OF CALCULATION</u>	<u>EXAMPLE</u>	<u>KEYSTROKES</u>	<u>DISPLAY</u>
<b>ADDITION/ SUBTRACTION</b>	5 12 + 22 - 32	$\boxed{1}$ <sub>5</sub> $\boxed{J}$ <sub>1</sub> $\boxed{K}$ <sub>2</sub>	5 12.
		$\boxed{?}$ <sub>/</sub> $\boxed{K}$ <sub>2</sub> $\boxed{K}$ <sub>2</sub>	22.+
		$\boxed{:}$ <sub>9</sub> $\boxed{L}$ <sub>3</sub> $\boxed{K}$ <sub>2</sub>	32.-
		$\boxed{M}$ <sub>=</sub>	502.=
<b>MULTIPLICATION</b>	12 x 12 x 3.14	$\boxed{J}$ <sub>1</sub> $\boxed{K}$ <sub>2</sub>	12.
		$\boxed{P}$ <sub>x</sub> $\boxed{J}$ <sub>1</sub> $\boxed{K}$ <sub>2</sub>	12.x
		$\boxed{P}$ <sub>x</sub> $\boxed{L}$ <sub>3</sub> $\boxed{>}$ <sub>.</sub> $\boxed{J}$ <sub>1</sub> $\boxed{U}$ <sub>4</sub>	3.14 x
		$\boxed{M}$ <sub>=</sub>	452.16 =
<b>DIVISION</b>	100 ÷ 6	$\boxed{J}$ <sub>1</sub> $\boxed{<}$ <sub>1 0</sub> $\boxed{<}$ <sub>1 0</sub>	100.
		$\boxed{)}$ <sub>0 ÷</sub> $\boxed{O}$ <sub>6</sub>	6. /
		$\boxed{M}$ <sub>=</sub>	16.666... =

TYPE OF CALCULATION	EXAMPLE	KEYSTROKES	DISPLAY
REPEATED ADDITION	9 + 5 + 5 + 5	$\left[ \begin{array}{c} ( \\ 9 \\ \end{array} \right]$ $\left[ \begin{array}{c} ? \\ / \\ + \\ \end{array} \right]$ $\left[ \begin{array}{c}   \\ 5 \\ \end{array} \right]$ $\left[ \begin{array}{c} M \\ = \\ \end{array} \right]$ $\left[ \begin{array}{c} M \\ = \\ \end{array} \right]$ $\left[ \begin{array}{c} M \\ = \\ \end{array} \right]$	9.
			5.+
			14.=
			5.+
			19.=
5.+			
24.=			
REPEATED SUBTRACTION	150 - 13 - 13 - 13	$\left[ \begin{array}{c} J \\ 1 \\ \end{array} \right]$ $\left[ \begin{array}{c}   \\ 5 \\ \end{array} \right]$ $\left[ \begin{array}{c} < \\ 5 \\ 0 \\ \end{array} \right]$ $\left[ \begin{array}{c} : \\ - \\ \end{array} \right]$ $\left[ \begin{array}{c} J \\ 1 \\ \end{array} \right]$ $\left[ \begin{array}{c}   \\ 3 \\ \end{array} \right]$ $\left[ \begin{array}{c} M \\ = \\ \end{array} \right]$ $\left[ \begin{array}{c} M \\ = \\ \end{array} \right]$ $\left[ \begin{array}{c} M \\ = \\ \end{array} \right]$	150.
			13.-
			137.=
			13.-
			124.=
13.-			
111.=			
REPEATED MULTIPLICATION	179.00 x .20 660.89 x .20 33.44 x .20	$\left[ \begin{array}{c} J \\ 1 \\ \end{array} \right]$ $\left[ \begin{array}{c} 7 \\ 7 \\ \end{array} \right]$ $\left[ \begin{array}{c} ( \\ 9 \\ 9 \\ \end{array} \right]$ $\left[ \begin{array}{c} P \\ x \\ \end{array} \right]$ $\left[ \begin{array}{c} \cdot \\ . \\ \end{array} \right]$ $\left[ \begin{array}{c} K \\ 2 \\ \end{array} \right]$ $\left[ \begin{array}{c} < \\ 5 \\ 0 \\ \end{array} \right]$ $\left[ \begin{array}{c} M \\ = \\ \end{array} \right]$ $\left[ \begin{array}{c} O \\ 6 \\ \end{array} \right]$ $\left[ \begin{array}{c} O \\ 6 \\ \end{array} \right]$ $\left[ \begin{array}{c} < \\ 5 \\ 0 \\ \end{array} \right]$ $\left[ \begin{array}{c} \cdot \\ . \\ \end{array} \right]$ $\left[ \begin{array}{c} + \\ 8 \\ 8 \\ \end{array} \right]$ $\left[ \begin{array}{c} ( \\ 9 \\ 9 \\ \end{array} \right]$ $\left[ \begin{array}{c} M \\ = \\ \end{array} \right]$ $\left[ \begin{array}{c}   \\ 3 \\ \end{array} \right]$ $\left[ \begin{array}{c}   \\ 3 \\ \end{array} \right]$ $\left[ \begin{array}{c} \cdot \\ . \\ \end{array} \right]$ $\left[ \begin{array}{c} U \\ 4 \\ \end{array} \right]$ $\left[ \begin{array}{c} U \\ 4 \\ \end{array} \right]$ $\left[ \begin{array}{c} M \\ = \\ \end{array} \right]$	179.
			.2 x
			35.8 =
			660.89
			.2 x
			132.178 =
			33.44
			.2 x
			6.688 =

# Operation

---

TYPE OF CALCULATION	EXAMPLE	KEYSTROKES	DISPLAY
<b>REPEATED DIVISION</b>	179.00 ÷ 5	J <sub>1</sub> 5 7 ( ) I <sub>5</sub>	179.
	660.69 ÷ 5	J <sub>1</sub> 7 9 0 ÷ I <sub>5</sub>	5. /
	33.44 ÷ 5	M =	35.8 =
NOTE: FOR CONSTANT DIVISION WITH THE SAME DIVIDEND (i.e., A NUMBER DIVIDED BY VARIOUS OTHER NUMBERS), STORE THE DIVIDEND AS THE MEMORY VALUE			
WITH $\overset{\wedge}{6}_{MC}$ & $\overset{N}{M+}$ AND RECALL IT		O <sub>6</sub> O <sub>6</sub> < > + ( )	660.89
		M =	5. /
AS NEEDED WITH $\overset{Y}{MR}$		L <sub>3</sub> L <sub>3</sub> > U <sub>4</sub> U <sub>4</sub>	132.178 =
		M =	33.44
			5. /
			6.666 =
<b>PERCENTAGE ADD-ON</b>	SALES TAX OF 6.5% ON SALE OF \$100.00	J <sub>1</sub> > < O <sub>6</sub> I <sub>5</sub>	1.065
	APPROACH: $1.065 \times 100.00$	P <sub>x</sub> J <sub>1</sub> < < M =	100. x 106.5 =
<b>PERCENTAGE DISCOUNT</b>	DISCOUNT OF 10% ON SALE OF \$345.00	J <sub>1</sub> : > J <sub>1</sub>	1.
	APPROACH: $(1.00 - .10) \times 345.00 = .90 \times 345.00$	P <sub>x</sub> L <sub>3</sub> U <sub>4</sub> I <sub>5</sub> M =	.1 - .9 = 345. x 310.5 =
<b>NEGATIVE NUMBERS</b>	$-3 \times -2$	L <sub>3</sub> - P <sub>x</sub> K <sub>2</sub> M =	-3. -2. x 6. =

## Operation

TYPE OF CALCULATION	EXAMPLE	KEYSTROKES	DISPLAY
---------------------	---------	------------	---------

## MEMORY CALCULATIONS

EXAMPLE 1.

$$(5 \times 3) + (6 \div 2) - 7$$

5	x	3	M+
---	---	---	----

5.  
3. x  
15. =

MEMORY VALUE = 15.

6	÷	2	M+
---	---	---	----

6.  
2. /  
3. =

MEMORY VALUE = 18.

5	7	M-
---	---	----

7.

MEMORY VALUE = 11.

NOTE: REMEMBER TO RESET THE MEMORY VALUE TO ZERO WITH

MC
----

BEFORE STARTING NEW MEMORY CALCULATIONS.

EXAMPLE 2.

$$(5.11 + 2.75) \times (0.2 - .099)$$

5	.	1	1	M+
2	.	7	5	M+
0	.	2	M-	
0	.	9	9	M-
x	=			

5.11  
2.75-  
7.86

MEMORY VALUE = 7.86

0	.	2	M-	
0	.	9	9	M-
x	=			

0.2  
0.099-  
0.101=  
7.86xM  
.79386=

## World Map Display

This display is called “home base” because it’s where you begin when the computer is turned on. The World Map display is also shown when you boot MS-DOS or change the Setup Menu.

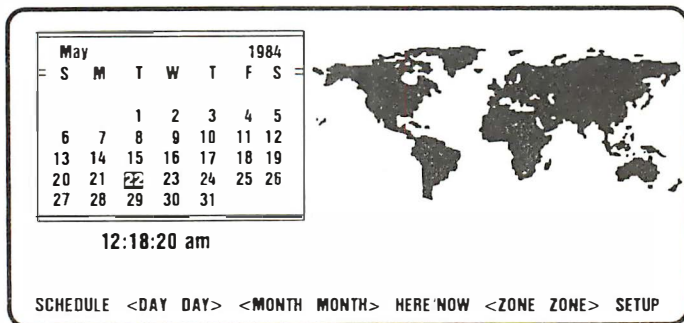

## Calendar and Clock

The World Map Display includes a calendar and clock readout for the current time and date. This is set for the correct time and date using the Setup Menu (more to follow on this).

On the bottom line of the display you'll see the following callouts:

SCHEDULE <DAY DAY> <MONTH MONTH> HERE/NOW <ZONE ZONE> SETUP

By pressing the function keys immediately below these words, you'll be able to do the following:

**SCHEDULE** — When the F1 function key is pressed, the Appointment calendar is activated. The schedule for the day that's highlighted on the Calendar of the World Map display will appear. To see the schedule for a day other than the current day, select the day on the World Map Display calendar before you press F1 (Schedule).

One you press F1 (Schedule) and a daily schedule appears, you can add appointments, erase them, change them, and even set an alarm. (See the section, “Appointment Calendar.”)

You can return to the World Map Display from the Appointment Calendar by pressing EXIT (F10). If you were checking the schedule of a day other than the current day, pressing HERE/NOW resets the calendar.

<**DAY DAY**> — By pressing either the F2 or F3 function key, you can select a day. The highlighted date on the calendar moves accordingly. These keys are **not** used to select the current date.

<**MONTH MONTH**> — The F4 and F5 keys control this function. They are very much like the DAY keys, except they change the **month**. You can also use these keys as if you were flipping through a regular calendar.

**HERE/NOW** — By pressing the F6 key, the calendar, clock, and map are reset to the present time, date, and time zone. Use it after you've checked the time in a foreign time zone. It also resets the date on the calendar.

<**ZONE ZONE**> — By pressing either the F7 or F8 function key, a vertical bar is moved across the world map, while changing the time display to show the time in foreign zones. In addition, key city names appear on the display.

Pressing F6 (Here/Now) returns you to your present time zone.

## Setup Menu

You call up the Setup Menu by pressing F10 when the World Map is displayed.

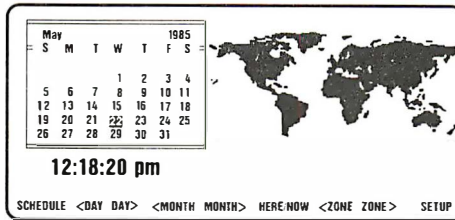

CLOCK	PRINTER	SERIAL PORT
Time: 14:22:00 Date: 07/05/84 Format: 24 hr. Time Zone: 19 New York Caracas	Type: PARALLEL	Baud rate: 1200 Data bits: 8 Stop bits: 1 Parity: None Handshake: XON/XOFF
DISPLAY	MODEM	INTERNAL MODEM
Ext. Mono. Adapter: OFF Screen Saver: ON	Location: INTERNAL	Baud rate: 1200 Data bits: 8 Parity: None
START-UP		
Action: World Map		
<SKIP SKIP>	CHANGE	System version 2.0 EXIT

This is what the Setup Menu looks like:

And this is how you “set up” your computer with it.



## Clock

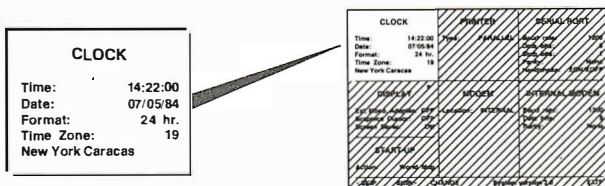

When you first turn your computer on, you'll have to set the *time*, *date*, and *time zone*. The only time you'll have to do this again is when you travel to other time zones.

Bring up the World Map Display. Now press function key **F6 (HERE/NOW)**. This will "clear" the display.

Next, press function key **F10** for SETUP.

Use **<SKIP (F1) or SKIP> (F2)** to select an item by moving the cursor (small rectangular block) forward (F2) or backward (F1). The item you're working with will be shown onscreen in reverse.

Press and hold **CHANGE (F4)** until the proper value is reached.

These are the clock settings you will probably need to change:

**Time** — Set the hour, minutes, and seconds separately. The hour will appear in either 12-hour or 24-hour format, depending on the setting of "Format" below. The seconds are always set to 00 when you press F4 to change them. Reset the time as you would any clock when you change time zones or when daylight savings time arrives or leaves.

**Date** — Set the month, day, and year separately. The computer automatically adjusts for months with fewer than 31 days. It also adjusts for leap years.

**Format** — This item decides whether time is shown in standard 12-hour format, or 24-hour format, on both the World Map Display and the Setup Menu.

**Time Zone** — Set this to reflect the time zone you're in right now. The computer will then tell you what time it is elsewhere in the world.

## Operation

---

The following table shows the 24 time zones the computer uses, along with representative cities or countries. (The cities and countries shown in parentheses are also representative of the area, but are not displayed on the screen.) The zone number reflects the offset in hours from Greenwich Mean Time.

**Time Zone Table**

<b>Zone</b>	<b>Location</b>
0	London, Lisbon, Reykjavik (Morocco, Mauritania, Ivory Coast)
1	Paris, Rome, Copenhagen (Berlin, Madrid, Oslo, Stockholm, Warsaw, Vienna, Algiers)
2	Athens, Cairo (Jerusalem, Bucharest, Tripoli, Helsinki, Johannesburg)
3	Moscow, Iraq (Turkey, Madagascar, East Africa)
4	Iran, Afghanistan (Gorky)
5	Pakistan
6	India, Nepal (Bangladesh)
7	Thailand, Viet Nam (Sumatra, Laos, Java)
8	China, Phillipines (Mongolia, West Australia)
9	Japan, Korea (Central Australia)
10	Sydney, Guam (Brisbane, Melbourne, New Guinea)
11	Solomon Is., New Caledonia
12	New Zealand, Fiji
13	Nome, Midway, West. Samoa
14	Anchorage, Hawaii, Tahiti (Cook Islands)
15	Pitcairn, Marquesas Is.
16	Los Angeles, Vancouver (Seattle)
17	Denver, Edmonton, Mazatlan (Phoenix)
18	Chicago, Winnipeg, (Dallas, Mexico City, Central America)
19	New York, Ciba, Bogota (Montreal, Panama)
20	Halifax, Caracas, Santiago
21	Rio de Janeiro, Greenland (Sao Paulo, Buenos Aires)
22	Trinidad, Falkland Is.
23	Azores, Cape Verde

There will be some variations, since the computer simply divides the world into 24 neat longitudinal zones. Some time zones will be 15 or 30 minutes off. And the computer doesn't take daylight saving time variations into consideration either.

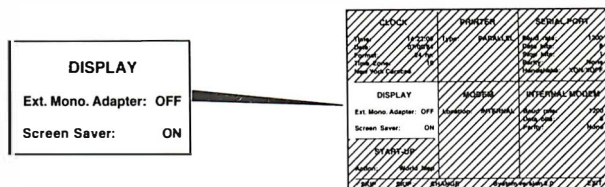

## Display

**Ext. Mono. Adapter (External Monochrome Adapter)** — Usually set to OFF, except when you've added extra monochrome equipment.

**Screen Saver** — Leave this ON for all normal situations.

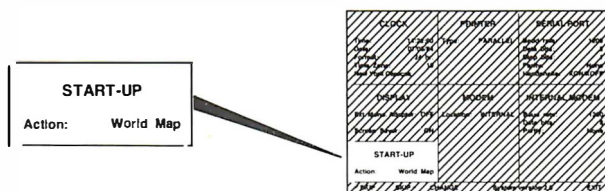

## Start-Up

**Action** — Your choices here are the World Map Display or Boot. If you choose the World Map Display, you will see the World Map when you start up your computer. If you choose Boot, the computer will automatically try to boot your MS-DOS system disk.

## Operation

---

PRINTER		SERIAL PORT	
Type:	PARALLEL	Baud rate:	1200
		Data bits:	8
		Stop bits:	1
		Parity:	None
		Handshake:	XON/XOFF

DEVICE	PRINTER	SERIAL PORT
Type	PARALLEL	Baud rate
Type		Data bits
Type		Stop bits
Type		Parity
Type		Handshake
PRINTER	PARALLEL	SERIAL PORT
Type		Baud rate
Type		Data bits
Type		Stop bits
Type		Parity
Type		Handshake

### Printer/Serial Port

Because of the greater flexibility of the MS-DOS CONFIGUR program, this portion of the Setup Menu is not used when setting up your computer and printer. However, the items mentioned on this display are the same items you'll be considering when you use the CONFIGUR program.

Basically, there are two types of printers, parallel and serial (Centronics-type).

The term serial means that data is broken down into its component parts, either characters (bytes) or bits. These bytes or bits are then transmitted one after the other (usually on three wires) from the computer to the printer.

Parallel means that eight bits (or a byte) is sent all at once across eight wires.

**Baud rate** — This is the speed at which a serial printer (or other device) and the computer will communicate. Standard baud rates are 110, 300, 600, 1200, 2400, and 9600. The most common for printers are 300, 1200, and 2400. Set the computer and the printer for the same baud rate. If the printer has switches for setting the baud rate, set it at the highest baud rate possible.

**Data bits** — This is the number of bits the printer expects the computer to use for representing a letter or other character. For modern printers, 8 bits is normal. This number does not include stop bits, which are set separately. It does include the parity bit, which may or may not be used.

**Stop bits** — This is what tells the printer that's the end of a character. The normal setting for this is 1. Occasionally a printer will require 2. Check your printer documentation to be sure.

**Parity** — If your printer has switches for parity processing, set them so parity is Disabled. Then set the computer Parity to None. The only time you should select Odd or Even parity for the computer, is when the device being used with the computer demands it. Again, check the device's documentation.

**Handshake** — This is how the printer communicates with the computer to tell it not to send any more characters for a while. There are three possible settings: Hardware, XON/XOFF, and No Handshake. Most of the time you will set this for XON/XOFF, also known as software handshaking. This is the preferred setting. The Hardware method is used by some older printers. It uses a special wire in the cable to communicate with the computer. It attaches to pin 20 on the computer. Check the printer documentation for the pin on the printer. The other choice, No Handshake, is seldom used.

# Operation

---

CLOSE	PROCES	SERIAL PORT
Stop Cancel Help Print Quit	Stop Cancel Help Print Quit	Baud rate: 1200 Data bits: 8 Parity: None
MODEM	MODEM	INTERNAL MODEM
Stop Cancel Help Print Quit	Location: INTERNAL	Baud rate: 1200 Data bits: 8 Parity: None
STARTUP		
Stop Cancel Help Print Quit		
STOP QUIT CHANGE	System version 2.0	EXIT

MODEM	INTERNAL MODEM
Location: INTERNAL	Baud rate: 1200 Data bits: 8 Parity: None
System version 2.0	
EXIT	

## Modem

**Location** — Your choices are Internal or External. Choose Internal if you're using the internal modem or External if an external modem is attached to the computer's serial connector.

## Internal Modem

These items control your computer's optional built-in modem. They basically are chosen using the same considerations as you do when you set up a serial printer.

## Appointment Calendar

The Appointment Calendar is a useful feature that helps you keep track of a busy schedule. There are 4,000 bytes of NVRAM (non-volatile memory) available. This is what the computer uses for storing appointments. If you have the optional modem installed, it shares this memory with the phone numbers that you have entered for modem operation.

To bring the Appointment Calendar up on your display, select the day for the Appointment Calendar at the World Map Display before you press SCHEDULE. Use the MONTH and DAY keys until the day you want is shown in reverse video. Then press F1.

<b>AM</b>	<b>October 15</b>	<b>PM</b>	<b>2544 Bytes Free</b>
6:00		12:00	
7:00		1:00	
8:00		2:00	<b>Pick up Judy at airport.</b>
8:30	<b>Breakfast with Dave &amp; Co.</b>	3:00	
9:00		4:00	<b>Board meeting. Don't</b>
10:00	<b>Meeting with HP reps.</b>	4:01	<b>forget copies of report!</b>
11:00		5:00	
<DAY DAY> INSERT ERASE ALARM			EXIT

This is how a typical day's schedule might look.

The entry at the top of the appointment calendar, XXXX Bytes Free, tells you how much memory is available for appointments and phone numbers. When NVRAM gets full (0 bytes free), the computer makes room for new appointments and phone numbers by erasing your oldest appointments, one at a time. If you have the optional modem installed, and have an extremely large phone directory, it will limit your appointment space since the computer automatically deletes your oldest appointments, never phone numbers.

## Operation

---

The four arrow keys in the lower right corner of the keyboard are used to move around the schedule display. The RETURN key can also be used to step through the time slots.

The regular keyboard is used for entering text. When you are at the point in the schedule where you want to enter text, just begin typing. You can correct mistyped entries either by erasing the complete entry with the ERASE key or by using the DEL key in the upper-right corner to back up and erase a character at a time.

Some of the function keys are used for the following actions:

**<DAY DAY>** — By pressing either the F1 or F2 function keys located directly below the <DAY DAY>, you can step ahead a day at a time, or step backwards a day at a time. If you activated the calendar without selecting a day at the World Map, you will begin with today's schedule.

**INSERT** — The initial (empty) display for a day's schedule only includes hourly entries from 6:00 a.m. to 5:00 p.m. All other entries are inserted with the INSERT (F3) key. When this key is pressed, a blank line is created underneath, with the same hour as the line above it. Then you just type in the minutes and continue typing the text for the appointment. The minutes must be between 01 and 59. One exception: When you insert appointments after 5 p.m., the minute setting can be 00; you must also type the hour. You can insert as many extra numbers as you have room for on the screen.

The Insert function can also be used to create extra lines for an entry that is longer than a single line.

**ERASE** — There are two ways to change the text for an appointment. You can type over the old text, or erase it with the ERASE (F4) key. The ERASE function will also delete any inserted time slots that are no longer needed.

**ALARM** — Pressing the F5 key sets the alarm for an appointment. If you change your mind, pressing the F5 again will cancel the alarm.



When you've set the alarm for an appointment, the computer will beep five minutes before the appointment time. It will beep for 10 seconds or until you press the ESC key or until you press SCHEDULE to activate the calendar. If you don't do any of these things, the computer will beep once again every minute for ten minutes. After that, it cancels itself.

*The computer must be turned on for the alarm to work.*

**EXIT** — Press F10 to return to the World Map Display. If you were running a program, press the Disk Icon to continue with the program.

## Connecting Devices to Your Computer

### General

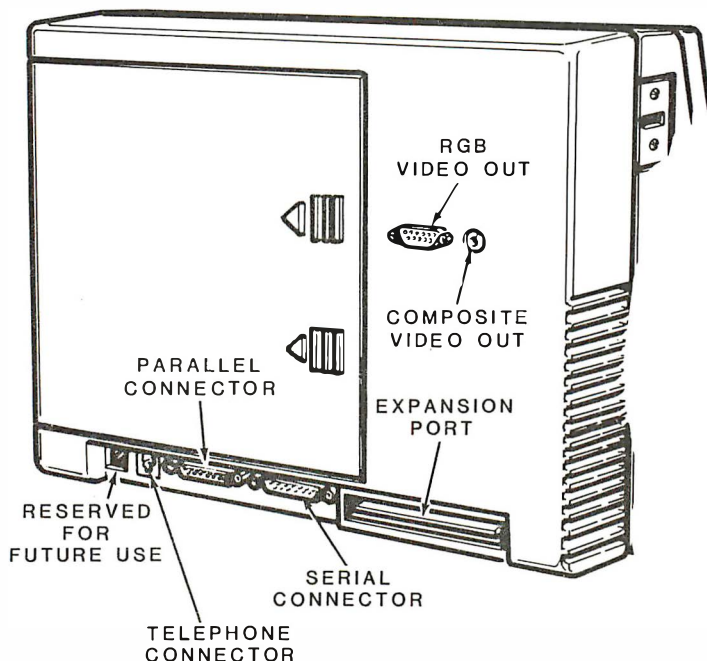

These are the connectors on the computer's back panel. They allow you to attach printers, plotters, and external modems. With the addition of the optional Internal Color Video Card, you can use external monitors.

**Telephone (RJ-11) Connector** — This connects the optional internal modem to the phone line. If the internal modem isn't present, this socket is nonoperative.

**Parallel Connector** — Used almost exclusively for parallel or Centronics-type printers.

**Serial Connector** — Used for serial printers, plotters, and external modems. Printers can be one of two types, serial or parallel. It simply means their method of communicating with the computer. Plotters are special printers that are used to draw graphs and pictures. External modems may be used instead of the computer's built-in modem to get 2400 baud transmission rates.

The serial connector may also be used with certain joysticks, mice, and graphics tablets. The software that comes with these devices should be written for PC-DOS or MS-DOS. The device itself must be designed to attach to the IBM-PC Asynchronous Communications Adapter (or equivalent) serial connector. It should not come with its own circuit board for mounting inside the computer, nor should it be designed to hook up to an IBM-PC keyboard connector.

**Composite Video Connector (optional)** — This is an RCA-style socket for connecting the optional Internal Color Video Card to an external monitor. Output complies with the RG-170 standard.

A cable is run from this connector to a similar one on either a color or a black and white monitor. The monitor connector is probably labeled "Video In."

This connector supplies only black and white signals — colors are simulated with shades of gray.

**RGB Color Monitor Connector (optional)** — This 9-pin socket is compatible with the socket on an IBM-PC type color/graphics adapter. It is designed solely to connect the optional Internal Color Video Card to a direct-drive RGB-type color monitor. This will let you view full-color displays of software written for an IBM-type color/graphics adapter.

## Operation

---

### Connector Pinouts

Following are the pinouts for the cables.

**NOTE:** An asterisk after the signal name indicates the signal is active on a low logic level.

#### Parallel Connector

All signals are at TTL level.

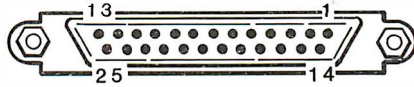

PIN NO.	PRINTER
1	STROBE
2	DATA0
3	DATA1
4	DATA2
5	DATA3
6	DATA4
7	DATA5
8	DATA6
9	DATA7
10	ACK
11	BUSY
12	PAPER OUT
13	SELECT
14	AUTO FEED
15	ERROR
16	INIT
17	SELECT IN
18-25	FRAME GND

#### Serial Connector

All signals are at TTL level, except current loop. Pins not shown are not used.

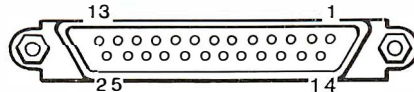

PIN NO.	SERIAL DEVICE
1	GND
2	SOUT *
3	SIN
4	RQS
5	CLS
6	DSR
7	GND
8	CD
20	DTR
22	RING

### Expansion Bus Connector

All signals are at TTL level. Pins A1, B3, B5, B7, B9, and B29 are non-IBM standard. 5V and 12V are not supplied on the bus.

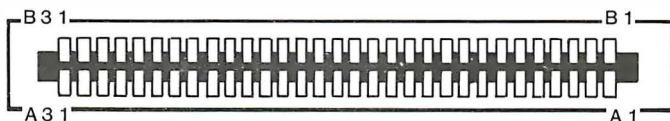

<u>PIN NO.</u>	<u>SIGNAL</u>	<u>PIN NO.</u>	<u>SIGNAL</u>
A 1	NC	B 1	GND
A 2	D 7	B 2	RESET DRV
A 3	D 6	B 3	+5V
A 4	D 5	B 4	IRQ2
A 5	D 4	B 5	GND
A 6	D 3	B 6	DRQ2
A 7	D 2	B 7	GND
A 8	D 1	B 8	NC
A 9	D 0	B 9	GND
A 10	I/O CH RDY	B 10	GND
A 11	AEN	B 11	MEMW*
A 12	A 19	B 12	MEMR*
A 13	A 18	B 13	IOW*
A 14	A 17	B 14	IOR*
A 15	A 16	B 15	DACK 3*
A 16	A 15	B 16	DRQ3
A 17	A 14	B 17	DACK 1*
A 18	A 13	B 18	DRQ 1
A 19	A 12	B 19	DACK 0*
A 20	A 11	B 20	CLOCK
A 21	A 10	B 21	IRQ7
A 22	A 9	B 22	IRQ6
A 23	A 8	B 23	IRQ5
A 24	A 7	B 24	IRQ4
A 25	A 6	B 25	IRQ3
A 26	A 5	B 26	DACK 2*
A 27	A 4	B 27	T/C
A 28	A 3	B 28	ALE
A 29	A 2	B 29	GND
A 30	A 1	B 30	MCLK
A 31	A 0	B 31	GND

## Printers

There are four basic things to remember when you hook up a printer.

- Make sure you have the right cable.
- Use the CONFIGUR program to set the computer serial port (for serial printers) and set the printer's switches correctly.
- Install your software for the printer, if necessary.
- Be sure the printer power switch is on.

### Parallel Printer

If you have a parallel or Centronics-type printer, all you need to do is connect your printer to the parallel connector on the computer.

### Serial Printer

Setting up a serial printer takes a few more steps.

First check that you have the proper cable. You will need a null-modem, RS-232C cable with a suitable DB-25 connector. (Check with your Zenith distributor for the proper cable.)

Next, you must run the MS-DOS CONFIGUR (configuration) program. (Refer to your MS-DOS documentation for the proper procedure.)

After running the CONFIGUR program, check to see if the printer is hooked up and all the settings are correct. First, be sure the printer is turned on, online, with paper and ribbon in place.

Boot MS-DOS. When the `A>` prompt is onscreen, press and hold the CTRL key and then press the **PRT ON** key. Then press **RETURN**.

Now anything that appears onscreen should go to the printer too.

Enter `DIR` and press **RETURN**.

Your printer is hooked up correctly if the Directory is printed out. If any of the following conditions occur, check for these possible causes.

- If you have a serial printer and the printing is not decipherable, check the baud rate settings of the computer and printer. They may be set to different rates.
- If you have a parallel printer, and the printing is not decipherable, check for a defective cable.
- No printing suggests it may be a bad cable. Also check that your printer is online.
- Some good printing and then a lockup or undecipherable printing indicates a handshaking problem. (See page 47.)

If you have to reset the computer, hold down the **CTRL** and **ALT** keys and then the **INSERT/DELETE**.





# In Case of Difficulty

## Service and Warranty

All Zenith Data System (ZDS) computer products, hardware and software, are designed to work together as a complete system. For proper operation, use your computer with other ZDS designed or approved accessories. Zenith Data Systems does not assume responsibility for improper operation that results from custom interfacing, custom software, or the use of accessories not approved by Zenith Data Systems.

Your computer has been wired and tested at the factory. If you encounter any malfunction during the warranty period, call your authorized repair facility for service. Do **not** attempt to service this computer yourself during the warranty period; to do so could void the Warranty.

To locate a Zenith Data Systems dealer or authorized Zenith Data Systems repair facility, check the Service Center Listing that you received with your computer or call 1-800-842-9000 for the name and location of the one nearest you.

**IMPORTANT:** When you contact a Zenith Data Systems dealer or authorized repair facility, list the following information about your computer system. It will help them diagnose and repair your unit.

1. The problem you are having.
2. The name, model number, and series number of your computer.
3. The system configuration, including any peripherals you are using.
4. Any additional information that will help describe your system.

## Automatic Tests at Power-Up

The power-up checks are automatically made on the following when the computer is first turned on:

- Central Processing Unit (CPU)
- Read-Only Memory (ROM)
- User Random Access Memory
- Interrupt Control and Timer Circuits
- Keyboard Microprocessor
- Disk Drive Read
- Disk Drive Seek Function
- Disk Controller
- Disk Direct Memory Access (DMA) Overrun
- Disk Cyclic Redundancy Check (CRC)
- Disk Address Mark

The following is a list of messages that may be displayed at power-up or during the self-tests. Possible solutions are also listed. If the suggestions are ineffective, have your computer checked by a qualified service technician.

### What the Power-Up Messages Mean

```
+++ ERROR: CPU failure! +++  
+++ ERROR: ROM checksum failure! +++
```

These two messages indicate the CPU logic may not be working properly. The checksum message is a result of a mismatch between a predetermined value and a value derived from the contents of the system ROM. Turn the machine off, wait 5 seconds, then turn it on again. If the same message reoccurs, you will need to have your system serviced by a qualified individual.

```
+++ ERROR: RAM failure! Address: XXXX:YYYY, Bit: N, Chip XXX +++
```

This message indicates the CPU is unable to read from or write to RAM or video RAM. If the displayed chip number is a 400 number, the failure is on the RAM board. If the chip number is a 300 number, the failure is on the Video board.

```
+++ ERROR: Timer interrupt failure! +++
```

This message indicates the timing logic on the CPU board may have failed. Make sure the timer chip is properly seated.

```
+++ DISK ERROR: Drive not ready! +++  
+++ DISK ERROR: Seek failure! +++
```

These messages usually occur when you are attempting to boot an operating system. The cause is usually an open drive door or the disk being improperly inserted in the system.

```
+++ DISK ERROR: Bad disk controller! +++  
+++ DISK ERROR: DMA overrun error! +++
```

Messages of this nature usually indicate a problem on the disk controller board; however, they may also be caused by other defective boards in the system. If any nonstandard boards have been installed, suspect these boards first.

```
+++ DISK ERROR: Sector not found! +++  
+++ DISK ERROR: CRC error! +++  
+++ DISK ERROR: Invalid address mark detected! +++
```

These messages indicate that an operating system was not found on the selected drive disk, or that you have a defective drive. First try a different disk. If this message occurs often, it may be necessary to have the drive aligned or the disk controller board checked by a qualified individual.

### No Error Message

Occasionally a problem may occur that prevents anything, including an error message, from being displayed. If you are using a color RGB monitor, check the jumpers on the video board. Also make sure you are allowing enough time for any disk input/output problems to show up.

## **Additional Troubleshooting Hints**

### **Nothing happens, no matter what keys you press.**

- Can be caused by many things. It will be necessary to reset the computer by holding the CTRL and ALT keys and then press the Insert/Delete at the same time.

### **Computer won't operate.**

- Check the AC adapter connections, the wall socket, and the power switch.

### **Unrecognizable screen display.**

- Check battery, it may be low.

### **You hear the disk drives working, but "Booting" and other messages don't appear on the display.**

- Check the Setup Menu, the "External Monochrome Adapter" may be set to On; it should be set to Off. To turn this item off, open the disk drive doors, turn the computer off, wait a few seconds and turn it back on. When the World Map appears, press F10 to get to the Setup Menu. Make the change and press F10 to get back to the World Map. Be sure the MS-DOS disk is inserted into the front drive and press the Disk Icon to boot.

### **Error message keeps repeating.**

- Reset the computer.

# Specifications

Central Processor Unit (CPU)	
Processor .....	80C88 CMOS 16-bit processor.
Type .....	16 bit internal.
Clock Rate .....	4.77 MHz.
System Monitor ROM ...	MFM-170 Monitor consisting of 32K × 8 ROM, containing system support code, disk boot code, and menu-selectable utilities.
Memory .....	4K non-volatile RAM; 256K dynamic RAM.
Input/Output	
Serial I/O .....	DB25 RS-232C port, data programmable from 110 baud to 9600 baud. Full-duplex and half-duplex operation. Hardware XON-XOFF handshaking.
Serial I/O Mode .....	Compatible with IBM-PC asynchronous communications adapter.
Parallel I/O .....	DB25 Centronics-compatible parallel printer port.
Expansion .....	PC bus interface for optional expansion chassis or optional expansion chassis with Winchester storage.
Modem .....	RJ-11 modular connector.
Display .....	Liquid Crystal Display (LCD) 640 × 200 dot-addressable pixels; 80 characters × 25 lines.
Disk Drives .....	5-1/4" double-sided/double-density. 9 sectors/track; 362 kilobytes formatted. IBM-PC standard.
Power Requirements .....	+ 12.8 VDC (@ 2.5 amperes (32 watts)). 110 VAC to 220 VAC, selectable.

## Specifications

---

### AC Adapter Power

Requirements ..... 90–132 VAC @ 45–63 Hz;  
180–270 VAC @ 45–63 Hz.

**NOTE:** This setting should only be changed by a qualified service technician.

### Environment

Operating ..... 50°–90°F (10°–32°C).  
Storage ..... –40°–125°F (–40°–51°C).  
Humidity ..... 20% to 80% relative humidity.

### Measurements

Size ..... 9.5" H × 13" W × 6.1" D closed or .5"  
D open (24.1 × 33.0 × 15.5 or 34.2 cm).  
Weight (two drives) ..... 14.4 lbs (6.48 kg).  
With internal modem ... 14.7 lbs (6.62 kg).  
Battery Weight ..... 1.6 lbs (0.72 kg).

---

Zenith Data Systems reserves the right to discontinue products and to change specifications at any time without incurring any responsibility to incorporate these features in products previously sold.

# Appendix A, Options

## General Disassembly

The only time it will be necessary to disassemble the ZFL-171-42 Portable Computer is if you install an option, other than the battery pack. The following options are presently available.

- Battery Pack (ZA-170-1)
- Internal Color Video Card (ZA-170-3)
- 300/1200 Baud Modem (ZA-170-4)
- 256K Dynamic RAM Chips (Z-205-4)

**WARNING:** Before beginning disassembly of the computer, turn the computer power switch OFF and disconnect the AC adapter.

To remove the rear cover:

Turn the computer power switch OFF and disconnect the AC adapter.

Close the computer by gently swinging the keyboard up, holding it in its closed position and sliding the latches forward until they click into place.

Lay the computer down on the closed keyboard on a clean sturdy surface.

## Appendix A

---

**NOTE:** The four screws which you will remove in the next step also secure the main logic board. Make sure the main logic board stays in position by not changing the computer's position.

Using a Phillips screwdriver, remove the four screws which secure the back cover.

Remove the two screws from the RGB connector.

Lift off the back cover and set it aside.

Refer to the appropriate section for installing your option.

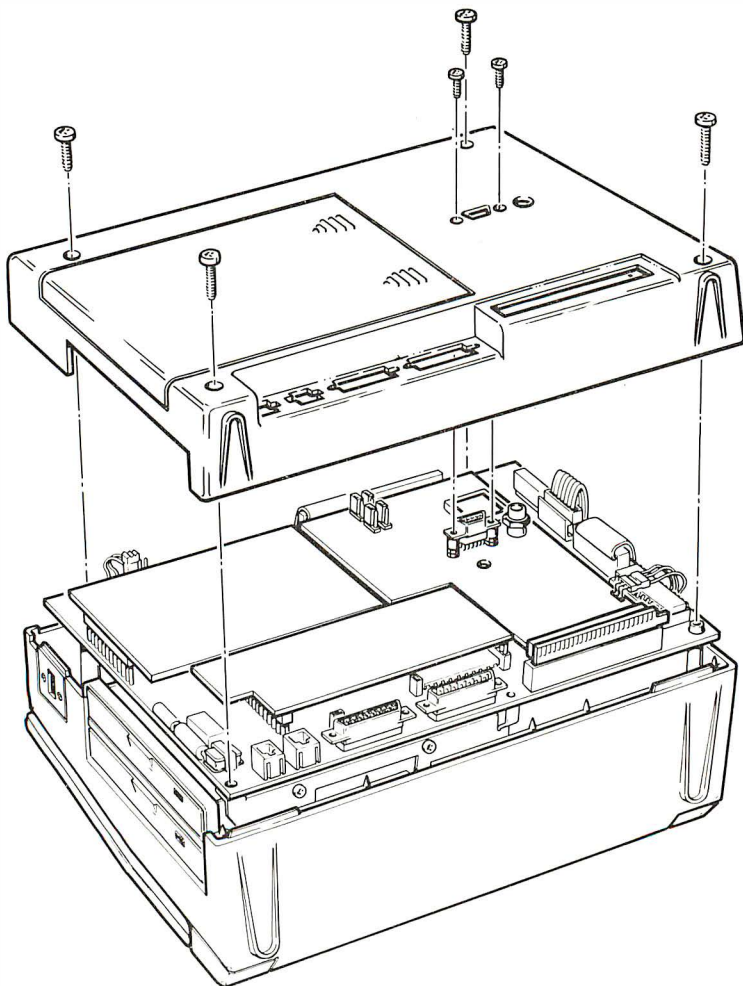



## Battery Pack Installation

To install the ZA-170-1 Battery Pack:

Turn the computer so you are looking at the side with the battery pack compartment. (This is on the same side as the On/Off switch.)

To open the battery pack compartment, squeeze the tab on the battery access door as shown in the inset below.

Slide the battery pack in as shown.

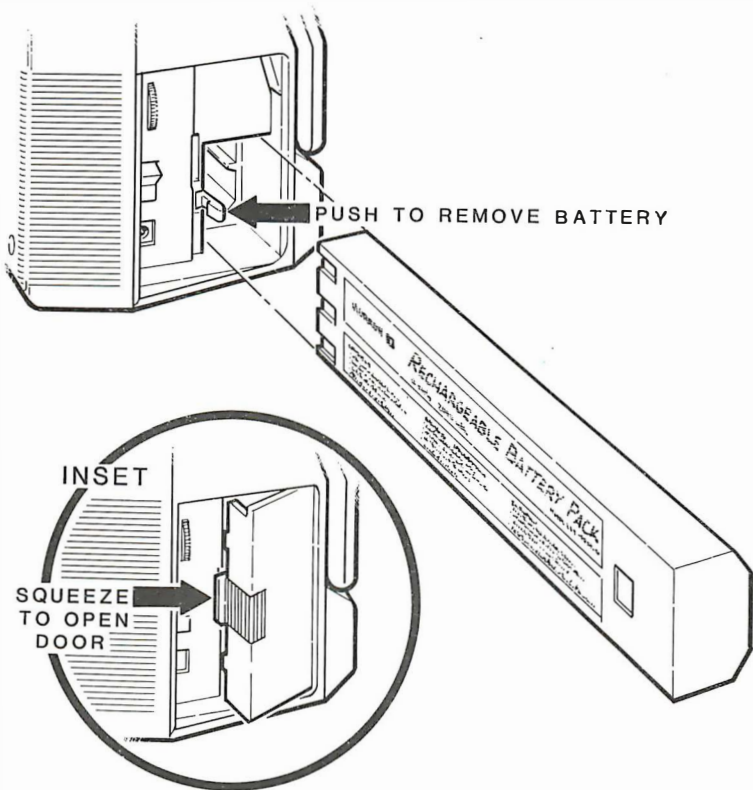

To remove a battery pack:

Release the battery pack from the computer by pushing the indicated tab.

**NOTES:**

1. Never remove the battery pack from the computer while running a program.
2. Do not disconnect the AC adapter while running a program, even if the battery pack is fully charged.
3. To charge the battery pack, leave the computer connected to the AC adapter with the power switch OFF for 8 or more hours. (The battery pack cannot be "overcharged.")
4. When the battery needs to be charged, the computer will beep and a "Battery Low" message will occur on the video display. When this happens, save the data on your working disk **immediately**. (If you wait the battery pack will become too weak to run the disk drives.) Connect the AC adapter.
5. The optional Internal Video Card will not operate when you are using only the battery pack. You must use the AC adapter.

## Internal Color Video Card Installation

The ZA-170-3 Color Video Card has a phono jack connector for connecting a monochrome monitor and a 9-pin D connector for connecting a color monitor. Two screws are also included to secure the connectors on the back cover after installation of the card. The AC adapter must be used with this option; it will not work with the internal battery pack.

To install the video card:

Remove the back cover from the computer. (See "General Disassembly.")

Refer to the illustration below and install the video card into the expansion chassis port at the bottom of the computer.

Connect the plug as shown.

Reinstall the back cover with the screws removed earlier.

Secure the video connectors on the back cover with the two screws supplied with the card.

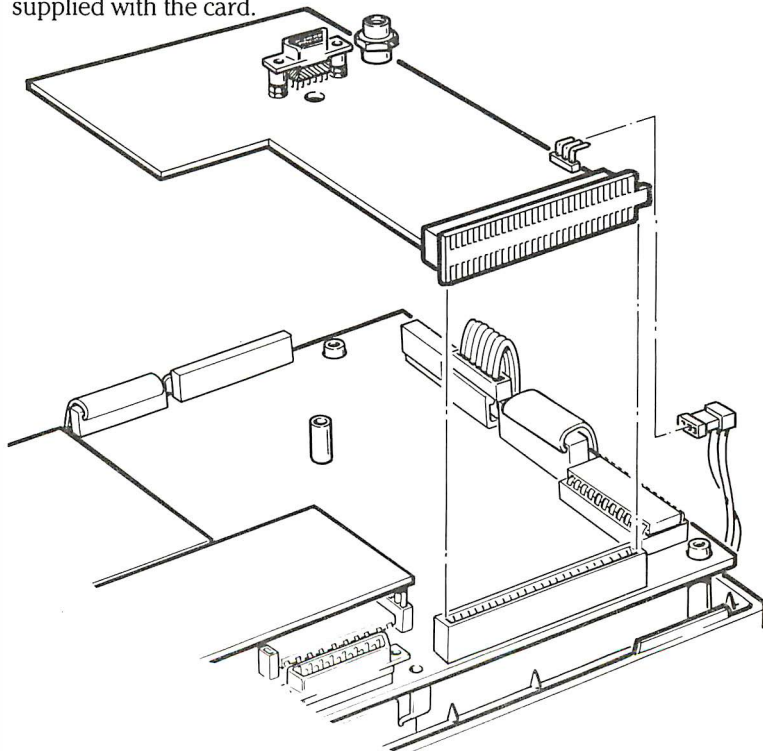

## 256K Dynamic RAM Chips Installation

**CAUTION:** Many integrated circuits (ICs) are electrostatic-sensitive and can be damaged by static electricity. Observe the following precautions when handling ICs.

- Once you remove an IC or a circuit board from its protective foam packing, envelope, or computer, **do not** lay the IC or board down or let go of it until you install it in your computer.
- It may be necessary to straighten the pins on an IC so they line up with the holes in an IC socket. When you bend the leads of an IC, hold the IC in one hand and place your other hand on your work surface before you touch the IC to the work surface. This equalizes the static electricity between the work surface and the IC. To straighten the pins, lay the IC down on its side and very carefully roll it toward the pins to bend the lower pins into line. Then turn the IC over and bend the pins on the other side.

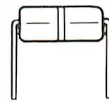

The 256K dynamic RAM chips (Z-205-4) are installed in complete banks (rows of ICs). Install the 256K dynamic RAM chips upgrade in bank C. (Additional upgrades are installed in bank D, then E.)

To install a bank of ICs:

Remove the back cover from the computer. (See “General Disassembly.”)

Remove the memory board by gently pulling straight up.

**NOTE:** Your package contains nine ICs. Set one IC aside in case future replacement is needed.

Install eight ICs as shown.

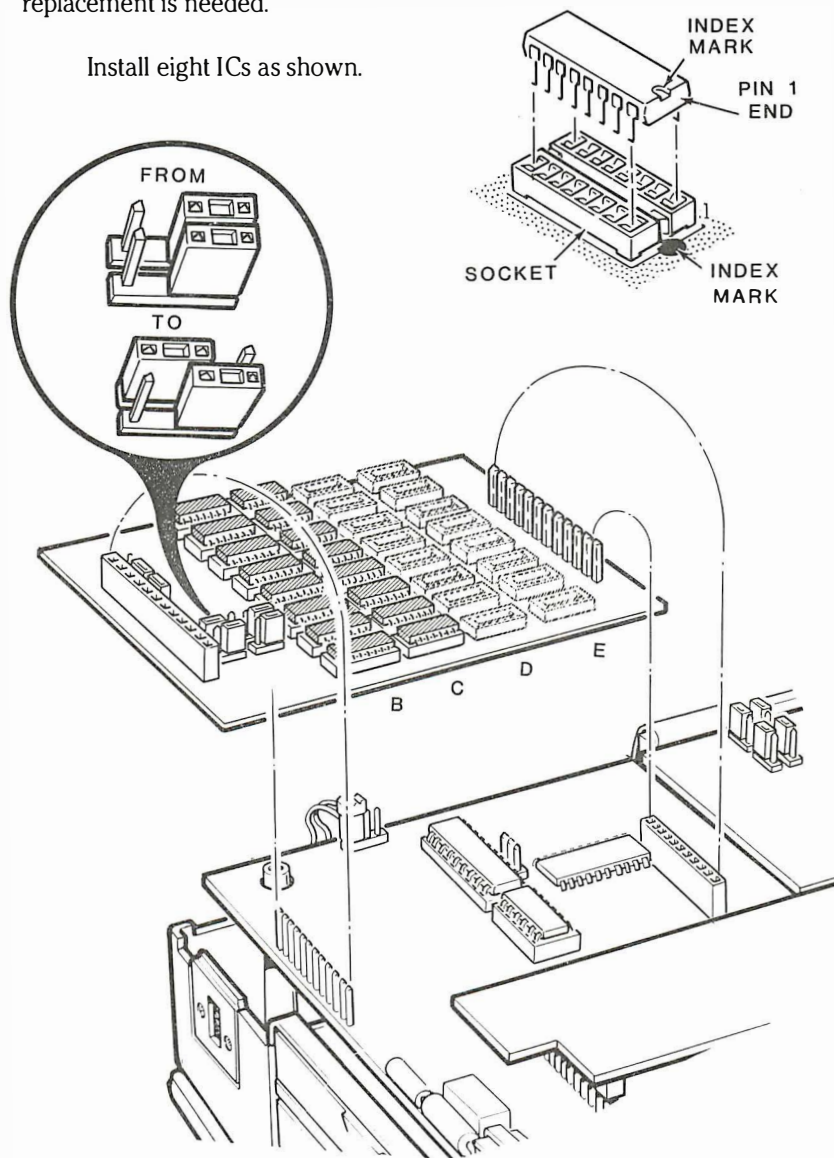

Change the setting on the jumper as shown.

Reinstall the memory board and the back cover.

## 300/1200 Baud Modem Installation

The ZA-170-4 Modem will let you to use a phone with your computer. To install the 300/1200 baud modem:

Remove the back cover from the computer. (See "General Disassembly.")

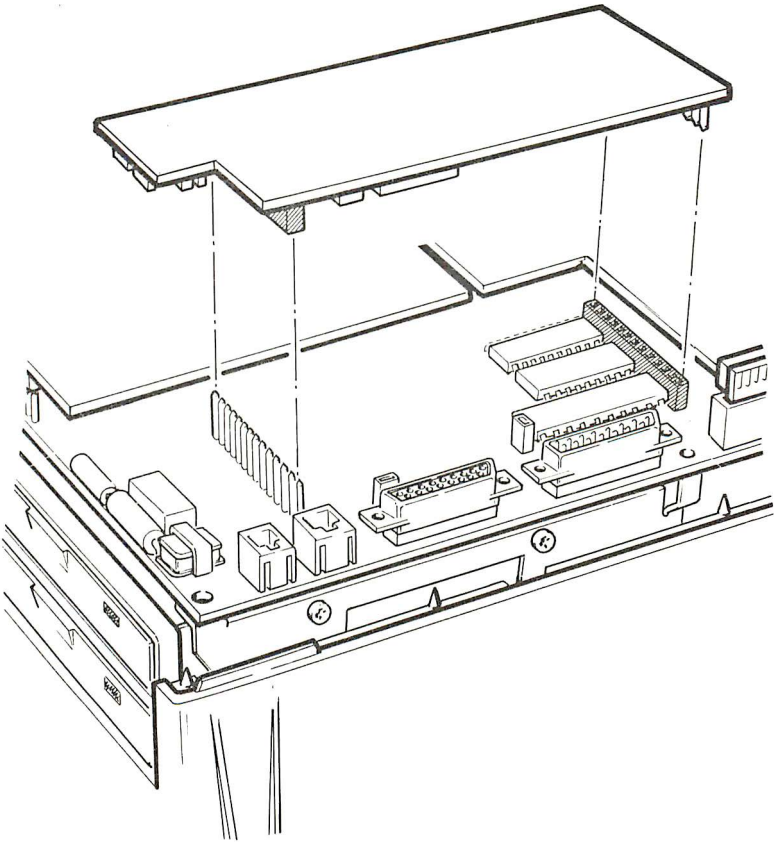

Line up the contact pins on the main board and the modem board and carefully press the modem board down onto the main board.

Reinstall the back cover.

The next step is to connect the computer to the telephone system. Some hookups will only require a piece of telephone cable with modular (standard RJ11-C) connectors. You may need other items, depending on the hardware used in your phone system.

To hook up a modular phone, either domestic or commercial:

Disconnect the modular plug from the telephone.

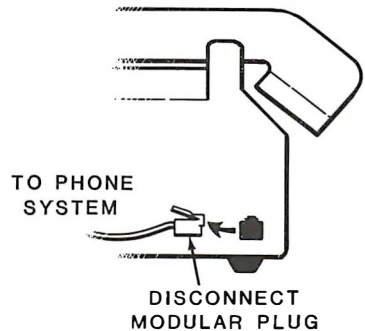

Install a duplex jack on the telephone.

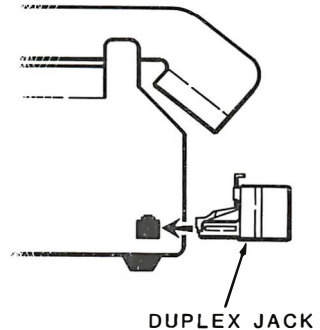

Connect a phone cable to either socket and the modem cable to the remaining one.

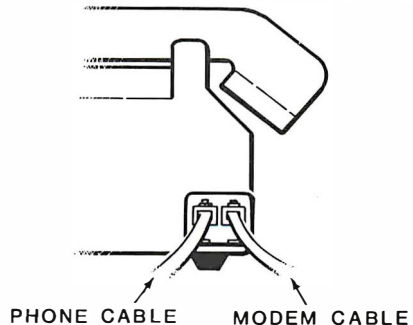

Appendix A

---

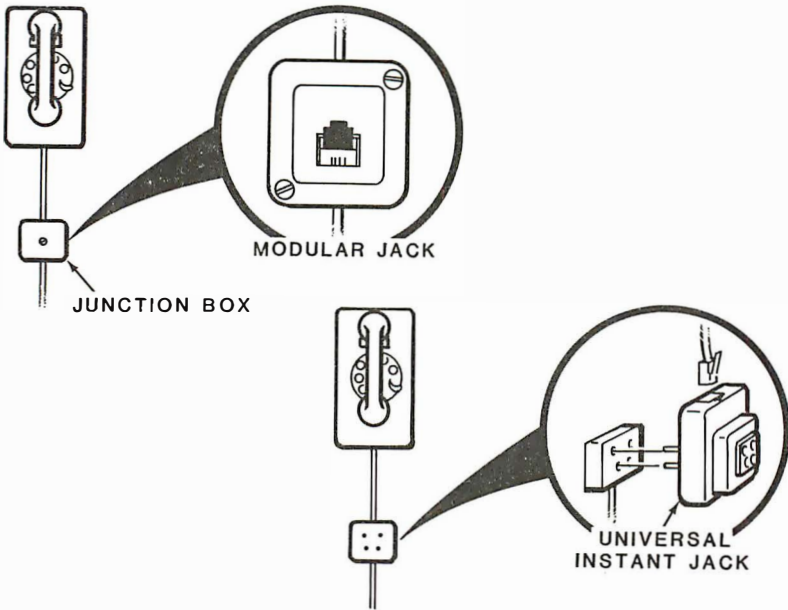

To connect a phone with a junction box or 4-pin plug:

Replace the junction box with a modular jack. Each screw inside the jack will have two wires of each color attached to it.

Add a "universal instant jack" to the phone socket. Plug the phone and modem cables into the universal jack.

To connect the modem to a PBX system:

Install a "Line One Tap" between the 24-pin connectors. Connect the modem cable to the tap.

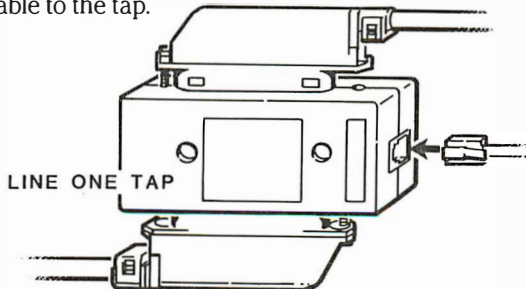

To operate the modem, set "External Mono Adapter" on the Setup Menu to OFF.



## 300/1200 Baud Modem Operation

### General

Modems are a combination of hardware and software that let computers talk to each other over telephone lines. Using the built-in modem, your computer can call data bases, electronic bulletin boards, and other personal computers.

Your modem has a unique feature: you can use the Phone Directory for automatic dialing of voice calls, not just modem (computerized) conversations. Throughout this section, we'll use the term voice calls to mean regular telephone calls that you let the computer dial and/or time for you. The calls which are carried out through the keyboard and display will be referred to as modem calls. With these, your telephone stays hung up.

When you're in the modem mode, there are two screen displays you will see. One is the Directory Display which you'll use when you choose a number to dial. The other is the Update Display which you'll see when you add, remove, or change a number.

You can enter the modem mode from other modes. For example, if you're running a business program or working with MS-DOS, all you need to do is press the Phone Icon. When your call is finished, press the appropriate icon to return to where you were. (If you made a modem call, it will be necessary to press the Phone Icon first to return to the Directory Display to hang up.)

The following keys are used to move the cursor around both the Directory Display and the Update Display:

**Return** — Press this key to move down through the directory list, one line at a time.

**Up and Down Arrow Keys** — Press this key to move the cursor up and down a line at a time. When the Shift key is pressed at the same time, it moves up and down a screenful at a time. The down arrow key can be used interchangeably with the Return key.

## Appendix A

---

**Letter Keys** — If you type a letter key while looking at the Directory Display, the cursor moves to the first entry in the list that begins with the letter you've typed. (This feature doesn't work when you're at the Update Display.)

The feature or function you choose is shown in reverse video.

### Directory Display

The Phone Directory display will look similar to this:

Area Code:	Prefix: 9	Call Timer: 00:00:00	2488 Bytes Free
#1 – Sprint		(616)555-4242	WWWWW12345 +
#2 – Home		(616)555-6783	
Action Graphics		(765)555-9243	
Al's Auto		(715)555-7653	
Allen, Mary		(616)555-0228	
American Photo		(982)555-3477	
Beta Bulletin Board		(616)555-7272M	
Dialed so far: <u>555-7272M</u>			
PREFIX DIAL #1 #2 KEYBOARD REDIAL HANGUP TIMER TERMINAL UPDATE			

Let's begin by defining the elements of the display.

**Area Code** — This is the number you'll enter as your local area code at the Update Display. The computer uses this information to determine whether to dial an area code. If the area code at the top of the display is the same as the area code contained in the number you choose for dialing, the computer knows it's a local call and doesn't dial the area code. If the numbers are different, the computer dials the area code.

**Prefix** — In certain situations, it's necessary to dial 9 to get an outside line or sometimes you may have to dial 1 when you're calling long distance. These are the times when you use the prefix function.

**Call Timer** — This does just what it says; it times calls. If you need to time the length of a phone call, you set the timer and when you're finished, you stop the timer. The computer, however, doesn't store this information; it's necessary for you to keep a record if you need to use the information in the future. This feature is useful for people like lawyers and consultants, and you can also use it to compare your record with bills from the phone company or data base service.

**XXXX Bytes Free** — The names and numbers for the phone directory are stored in a memory bank called NVRAM (non-volatile random access memory). When the computer is turned off, this memory is kept intact by a small built-in battery. Your computer has 4000 bytes of NVRAM. The Bytes Free indicator tells you how much of NVRAM is currently available for additions to the phone list. This memory space is also used by the Appointment Calendar.

**#1 and #2** — Frequently-called numbers are entered in these two special places. You can conveniently dial the two numbers at these locations by pressing the #1 or #2 function key. The numbers you choose for these locations can be numbers that are used for either voice calls or modem calls. They can also be part of a dialing sequence, such as a Sprint local number and your access code.

**Dialed so far:** — When Prefix, Dial, or Redial functions are being used, the number being dialed by the computer appears in this line.

The following are the Directory Display items that are controlled with the function keys.

**Prefix (F1)** — Use this key if you need a prefix as part of the dialing sequence. After using the Prefix, press Dial to dial the rest of the number from the directory, or Keyboard to dial the rest from the keyboard. This is an optional entry.

**Dial (F2)** — Press this key to begin dialing after you choose a number in the directory to dial. If you also need a prefix, it's necessary to press Prefix (F1) first.

**#1 and #2 (F3 and F4)** — Use these for speed dialing the numbers entered at these locations. It's not necessary to press Dial when you want to call these numbers, just press #1 or #2.

## Appendix A

---

**Keyboard (F5)** — Press this key when you want to manually enter a phone number from the keyboard.

**Redial (F6)** — Press this key to automatically redial the last number that was dialed, including a prefix (if one was used). This is especially useful when a number is “busy.” This feature works even if the computer has been turned off between calls.

**Hangup (F7)** — Press this key when the dialing sequence is completed.

With **voice** calls, press Hangup as soon as you pick up the telephone handset.

With **modem** calls, press the Phone Icon to return to the Directory Display, then press Hangup.

Even if you dial a busy number, you have to press Hangup or your phone will be “busy.”

**Timer (F8)** — Call timing automatically begins when a call is initiated. To let the computer know your call is over, press this key. During voice calls, the time is displayed onscreen (unless you ask the computer to perform another task). For modem calls, the time is displayed when you press the Phone Icon to return to the Directory Display to hang up. The computer does not retain the time in memory.

**Terminal (F9)** — Press this key when you want to use your computer as an input/output terminal (as part of a system where a mainframe computer is shared with many users).

**Update (F10)** — When you want to add new phone numbers, erase old numbers, change current numbers, or enter numbers in the #1 and #2 slots, press this key. It will take you to the Update Display where you can also set the values for the area code and prefix.

## Update Display

The Update Display looks a lot like the Directory Display. You move the cursor around the display with most of the same keys: the Up and Down arrows and Return. The Letter keys do not work at the Update Display.

<b>Area Code:</b>	<b>Prefix: 9</b>	<b>Call Timer: 00:00:00</b>	<b>2488 Bytes Free</b>
<b>#1 – Sprint</b>		<b>(616)555-4242</b>	<b>WWWWW12345 +</b>
<b>#2 – Home</b>		<b>(616)555-6783</b>	
<b>Action Graphics</b>		<b>(765)555-9243</b>	
<b>Al's Auto</b>		<b>(715)555-7653</b>	
<b>Allen, Mary</b>		<b>(616)555-0228</b>	
<b>American Photo</b>		<b>(982)555-3477</b>	
<b>Beta Bulletin Board</b>		<b>(616)555-7272M</b>	
<b>Special chars:</b>			
<b>T = Tone P = Pulse W = Wait 2 seconds M = Modem + = Add more</b>			
<b>PREFIX</b>	<b>AREA CODE</b>	<b>#1 #2</b>	<b>ADD REMOVE BACKUP EXIT</b>

When you're at the main Directory Display, you can get to the Update Display by pressing F10. When you have completed your entries at the Update Display, pressing F10 returns you to the Directory Display.

When you're at the Update Display, you can manipulate the numbers in your directory: add, remove (delete), or change.

## Appendix A

---

The following keys are used to make entries. For now, a brief description for each is given; we'll give you a few more details in a while and a couple of examples to more fully explain their functions.

<b>0 — 9</b>	For the actual phone number.
<b>M</b>	Signifies a modem call.
<b>P</b>	Indicates it's a telephone number for a phone in a "pulse" dialing phone system (the older rotary dialing phones).
<b>T</b>	Used when part of the number is dialed in pulse, and then it switches to tone (pushbutton phones).
<b>W</b>	Tells the computer to wait two seconds before dialing any more numbers. Can be used in series for longer pauses.
<b>+</b>	Tells the computer there's more numbers to process.
<b>( )</b>	Used when entering area codes for numbers in your directory.
<b>—</b>	The dash is used along with the digits when entering phone numbers.

The following are the Update Display items that are controlled with the function keys.

**Prefix (F1)** — Press this to establish any sequence of numbers or special letters (up to 10 maximum) that you need consistently at the beginning of calls. To clear an existing prefix, type over it with spaces and then press RETURN. A Prefix entry is only entered if your phone number entry requires one.

**Area Code (F2)** — Press this key to enter the area code for your current location. Only enter three digits, your area code will appear in parentheses automatically. If you make a mistake when entering the area code, press AREA CODE again and retype. Change this setting whenever you move to a location with a different area code.

**#1 and #2 (F3 and F4)** — Use these keys to set the names and numbers in the special #1 and #2 slots. These are the first two locations in the Directory Display. To enter a name and number at either of these locations, press either F3 or F4. The cursor will go to the upper left corner, ready to accept a name. Type in a name. If you're replacing a name, type over the old name with the new name. If the new name is shorter, replace the balance of the letters of the old name with spaces. Use the DEL key to correct typing errors. Press RETURN when you have entered the name. Then type the number and press RETURN. The name and number will stay in your choice of first or second place in the directory.

**Add (F5)** — Pressing this key will open a blank line toward the top of the screen and the cursor will be positioned for adding a new name. Type the name of the party (up to a maximum of 39 characters, including spaces). Use the DEL key to correct typing errors. Press the RETURN key to enter the name. The name now automatically appears in its alphabetical position in your directory. Next, enter the phone number, including the area code with parentheses (for a maximum of 39 characters including spaces). If you make an error, you can delete the entire entry by pressing REMOVE (F6). If you only need to correct the number, position the cursor with the Return or Arrow key and type the correct number over the wrong one. If the correct number is shorter than the one it's replacing, hit the Space bar to type over the remaining digits.

**Remove (F6)** — To delete names and numbers from the directory, position the cursor at the name or number by using either the Return or Arrow key. Then press F6. The entry is now removed from the directory, which will free memory for other entries.

**Exit (F10)** — When you finish updating the directory, pressing this key returns you to the main Directory Display.

## Backing Up the Phone Directory

The RAMBACK program is a utility on the Demonstration Disk that lets you make a backup copy of your phone directory. It also will read it back into memory if its ever needed. Backup copies of your phone directory should be made when the small battery used to power NVRAM is being changed or if your computer requires other servicing.

To make a backup copy of your phone directory:

Place your Demonstration Disk in drive A. When the A> prompt appears, enter RAMBAK and press **RETURN**.

Place a formatted disk in drive B and press B to back up or copy your phone directory on disk.

It's a good idea to back up your phone directory at frequent intervals; use the same disk, just update the label's date.

You can also restore the NVRAM contents by following the same procedure, only instead of choosing the B option, press **R**. Anything that's currently in NVRAM memory will be replaced by the information on the disk file, RAMBAK.DAT, which was created when you made the backup copy with RAMBAK. Only the information that was in your Directory when you made the backup will be filed. Updates since that time will not be included.

## Modem Operating Notes

1. The computer always dials numbers with tones unless you use a P in the number to signify Pulse dialing. P signifies that any digits after the P will be pulse dialed.
2. If you live in an area where local calls must be dialed in pulse, every one of your directory numbers might have to begin with a P. Or, you could enter P as all or part of your Prefix on the Update Display.
3. The only time you use T for tone is when part of a dialing sequence is pulse, and then it switches to tone. If the whole number can be dialed in tone, neither T nor P is needed.



4. W added after the number allows for the necessary time span for the telephone to access a phone system (like MCI or Sprint) or to gain access to an outside line, such as when you dial 9 in an office situation. W equals 2 seconds, WW equal 4 seconds, WWW equal 6 seconds, etc.
5. M signifies a Modem call. Unless you put an M as the last character in a phone number, the computer assumes it's a voice call. It dials and tells you to pick up the handset. M is used with modem calls. The computer dials and waits for an acknowledgement from the computer on the other end.
6. Most numbers will consist of only an area code and seven digits, with no letters.
7. A + added after the number means there is more; that this is only the first half of a long dialing sequence. Usually, you would use it at the end of a Sprint or MCI-type access number. The plus sign must be the last character in the first part of the number. When the computer dials a number that ends in +, it beeps and pauses. You would then move the reverse video bar to a number in the list (the second part of your number), and press DIAL, or press KEYBOARD to dial the second part from the keyboard.
8. When numbers are entered in the phone directory, they should all have area codes enclosed in parentheses. The computer will then recognize these numbers as area codes and will compare your area code with the area code of the number to be called. If they match, the area code will not be dialed. If they don't match, the computer will dial the area code.
9. When you add a new name/number, it's automatically placed in the proper alphabetical sequence in the directory (excluding the #1 and #2 entries).

## Appendix A

---

10. The built-in modem program was designed specifically for contacting remote computers and electronic bulletin boards. The computer's modem software does not allow you to send and receive disk files. For example, you cannot trade programs over the modem. When receiving text, the only way to capture it permanently is to use PRINT SCREEN repeatedly. When sending text, you must type it in on the keyboard during the call. The modem program does not answer calls from other computers. It only originates calls. If you need file transfer or answer-mode, you'll need other software.
  
11. If you're in the middle of a modem call, you can switch back to your program for a moment without breaking the connection by pressing the Diskette Icon. To return to the call, press the Phone Icon. This time, you go straight back to your modem call without passing through the directory. To get to the directory for hanging up, press the Phone Icon one more time, and then press HANGUP. Press the Disk Icon again to return to the program.

## Modem “Hands-On” Experience

The best way to learn how to use the modem is to use it. Let's go through the process of entering numbers and then telling your computer to dial a call for you.

1. First, turn on your computer. If the Start-Up Action on the Setup Menu is set to World Map, the World Map appears. If not, press the Clock Icon to go to the World Map.
2. Press **SETUP (F10)** to proceed to the Setup Menu.
3. Now press **SKIP>2 (F2)** until the cursor is on Location under MODEM. Be sure it's set to “Internal.” If not, press **CHANGE (F4)** to change it.
4. Press **SKIP> (F2)** until the cursor is next to Baud Rate in the Internal Modem column. It should show “1200.” Use **CHANGE (F4)** if necessary.
5. Press **SKIP** again to move down to Data Bits. Verify that Data equals “8.”
6. Press **SKIP** again to move down to Stop Bits. It should be set to “2”.
7. Again press **SKIP** to move to Parity. Check that its set to “None.”
8. Press **EXIT (F10)** to leave the Setup Menu. You should be back at the World Map Display now.
9. Now proceed to the Update Display by pressing the Phone Icon, and then the **UPDATE (F10)** key.
10. At the Update Display, press **AREA CODE (F2)**. The cursor will move to the area code part of the top line. Type in your present area code (three digits only).
11. Press **PREFIX (F1)** to move to “Prefix.” If you are in an office where you need to dial 9 or some other code to get an outside line, type that prefix here. Otherwise leave it blank. Press **RETURN**.

## Appendix A

---

12. Now put the phone number you wish to call in the phone directory by pressing **ADD (F5)**. Now type the name of the party. (Remember to use the DEL key to correct any typing errors.) Press **RETURN**. Now type the phone number, including the area code enclosed in parentheses. This can be any number up to 39 characters, including spaces. Now press **RETURN** and then **EXIT (F10)** to get back to the main Directory Display.
13. Now you should be back at the Directory Display and the phone number that you typed should be in reverse video. If not, press the **UP** or **DOWN** arrow key so the number is in reverse video.
14. If you're in an office or anywhere else that requires the prefix you (may have) entered in the last steps, press **PREFIX (F1)** now to dial it. If you didn't enter a prefix, skip this step.
15. Now press **DIAL (F2)**. The computer will begin to dial and the number will be shown in the "Dialed so far" line. When the number has been dialed, pick up your phone and press **HANGUP (F7)**. (Pressing "Hangup" doesn't hang up the phone, it simply takes the computer out of the circuit. It's always necessary to press "Hangup," even if the line was busy or there was no answer.) You should hear ringing or a busy signal. From here on, it's just like a regular telephone call.

Now we'll do a little "Hands-On" exercise by entering a modem number from the keyboard. This exercise serves three purposes: you'll know how to communicate through the modem, you'll learn to dial from the keyboard, and you'll be able to see what HUGs (Heath User's Group) electronic bulletin board is like.

1. Press **KEYBOARD (F5)**. You will be prompted to type a number into the "Number to Dial" line.
2. Type: 1-616-982-3956M. (If you live in a 616 area code, you can leave those numbers off, and type a prefix if you need one.) Use the number keys in the top row of the typewriter keyboard. Back up with the DEL key if you make a mistake, and retype. When the number's exactly right, press **DIAL (F2)**.

3. The computer will keep you informed of the dialing. If you get through (which is sometimes hard to do with busy bulletin boards), you'll proceed into communication with HUG's computer. Press the **RETURN** key until the bulletin board locks-in on your baud rate. If you don't get through, the "Waiting for signal" stays on the screen until you press **HANGUP**. You can then use **REDIAL (F6)** to try again in a moment.
4. After you've reached the HUG bulletin board, type **I** for instructions.
5. When you're through with the Bulletin Board, log off according to its instructions. Then press the Phone Icon to get back to the Directory Display. Then press **HANGUP**.

And that's all there is to dialing a modem call from the keyboard. If you have any questions regarding the bulletin board, give HUG a voice call at 1(616)982-3837.



## Appendix B, Software Summaries

This section of the manual contains the summaries of the operating system, MS-DOS and BASIC, along with code sequences for your Z-170 PC Series Computer. The Cross-Reference Keystroke Chart for the Z-100 PC Series and Z-170 PC Series and the Hayes Auto Dialing Protocol are also included.

### MS-DOS

The following pages are a summary of the control functions and commands that are available while you are using MS-DOS.

**Control Functions**

<u>KEY PRESSED</u>	<u>EVENT</u>
F1	Copy one character.
F2 <i>n</i>	Copy all characters up to the character "n".
F3	Copy all characters in buffer.
DEL	Skip one character.
F4 <i>n</i>	Skip all characters up to the character "n".
ESC	Cancel current line; do not affect template.
INS	Enter or exit insert mode (toggle).
F5	Create new template.
F6	Insert EOF (IAH) in new template.
ALT-BREAK	Empty keyboard buffer.
BACK SPACE	Backspace and delete character.
CTRL-ALT-DEL	Reset system.
CTRL-BREAK	Exit current function immediately.
CTRL-C	Exit current function after execution of preceding entries.
CTRL-H	Backspace and delete character.
CTRL-I	Move cursor to next tab column.
CTRL-J	In BASIC, insert a physical end-of-line and extend the current logical line beyond the physical limits of the display line.
CTRL-NUM LCK	Suspend all operation. Press any key to continue.
CTRL-PRT SC	Copy the current display to the printer.
CTRL-RETURN	In BASIC, insert a physical end-of-line and extend the current logical line beyond the physical limits of the display line.
CTRL-S	Suspend all operation. Press any key to continue.
RETURN	Execute current line.
TAB	Move cursor to next tab column.



## Syntax Notations

<u>FORM OR SYMBOL</u>	<u>DEFINITION</u>
CAPITALS	Required entry; enter the information exactly as shown.
<i>CAPITALS</i>	Names of keys; press the key(s) indicated.
<i>lowercase</i>	User entry.
<i>d:</i>	Drive name.
<i>path</i>	Path name.
<i>filename</i>	File name.
<i>filespec</i>	File specification: [ <i>d:</i> ][ <i>path</i> ][ <i>filename</i> ][ <i>.ext</i> ].
<i>.ext</i>	File extension.
<i>command</i>	MS-DOS command.
<i>unit</i>	Hardware unit number.
<i>keyword</i>	Alphanumeric combination of characters.
<i>dev</i>	Any valid I/O device.
<i>"string"</i>	A string of characters (used in search/compare commands).
<i>/switch</i>	Switch parameters.
<i>comment</i>	Comments to be displayed on screen.
[ ]	Optional entry.
...	Repeated entry.
CON	Console (keyboard and screen).
PRN	Parallel printer #1.
LPT1	Parallel printer #1.
LPT2	Parallel printer #2.
LPT3	Parallel printer #3.
AUX	Serial port #1.
COM1	Serial port #1.
COM2	Serial port #2.
CLOCK\$	Clock (on board).
>	Send to specified file.
>>	Append output to specified file.
<	Receive from specified file.
	Pipe information through utility.

**NOTE:** *External utilities* are external to the operating system and require specific disk files on the default or specified drive. *Internal commands* are part of the memory-resident operating system and do not require specific disk files to be present.

## Appendix B

---

### Commands

**APPLY** [-][d:] [path]filename "command"

**APPLY** "command" [-][d:] [path]filename

External utility. Executes an MS-DOS command and substitutes parameters according to material contained in the file specified.

**BACKUP** [?][[filespec[+filespec...]] [d:][filename][/switch...]]

External utility. Creates a single backup file on one or more disks for one or more files.

Switches:	/A[:date]	Back up files after <i>date</i> .
	/B[:date]	Back up files before <i>date</i> .
	/D	Provide directory of master backup files.
	/E	Back up all but exception files.
	/F	Format destination disks without prompt.
	/G	Global; back up subdirectories as well.
	/L	List internal backup file directory.
	/N	No formatting of destination disks.
	/Q	Query each source file.
	/R	List files to be backed up.
	/T	Back up files with today's date only.
	/V	Verify; read after write.
	/W	Back up files that have changed since last backup.

**BREAK** [ON | OFF]

Internal command. Turns on (or off) immediate response to CTRL-C or CTRL-BREAK key operations. If off, response is only during normal MS-DOS I/O operations. Turn off feature when running programs that make use of either CTRL-C or CTRL-BREAK.

**CD** [d:] [path]

**CHDIR** [d:] [path]

Internal command. Changes current directory to another directory *path*.



Appendix B

---

**DATE** [*mm-dd-yy*]

Internal command. Display and/or change date.

**DEBUG** *filespec* [*parameters*]

External utility. MS-DOS debugger.

Functions:

<b>A</b> <i>[addr]</i>	Assemble.
<b>C</b> <i>range addr</i>	Compare.
<b>D</b> <i>[addr]</i> [ <i>L val</i> ]	Dump.
<b>D</b> <i>[range]</i>	Dump.
<b>E</b> <i>addr</i> [ <i>list</i> ]	Enter.
<b>F</b> <i>range list</i>	Fill.
<b>G</b> [= <i>addr1</i> ] [ <i>addr2...</i> ]	Go.
<b>H</b> <i>addr1 addr2</i>	Hex.
<b>I</b> <i>val</i>	Input.
<b>L</b> <i>[addr</i> { <i>drive rec rec</i> }]	Load.
<b>M</b> <i>range addr</i>	Move.
<b>N</b> <i>filespec</i> [ <i>filespec...</i> ]	Name.
<b>O</b> <i>val byte</i>	Output.
<b>Q</b>	Quit.
<b>R</b> <i>[reg]</i>	Register.
<b>S</b> <i>range list</i>	Search.
<b>T</b> [= <i>addr</i> ] [ <i>val</i> ]	Trace.
<b>U</b> <i>[addr]</i> [ <i>L val</i> ]	Disassemble.
<b>U</b> <i>[range]</i>	Disassemble.
<b>W</b> <i>[addr</i> { <i>drive rec rec</i> }]	Write.

**DIR** [*d:*] [*path*] [*filespec*] [*/switch*]

Internal command. List requested directory entries.

Switches:

<b>/P</b>	Page mode.
<b>/W</b>	Wide display mode.

**DISKCOMP** [*filespec1*] [*filespec2*]

External utility. Compare the data of two identical disks.

**DISKCOPY** [*filespec1*] [*filespec2*] [*/switch*]

External utility. Duplicate a disk.

Switches:

<b>/V</b>	Verify; read after write.
-----------	---------------------------

ECHO [ON] [OFF] [*message*]

Internal command. Control echo feature of batch processor.

EDLIN *filespec*

External utility. MS-DOS line editor.

Commands:	<i>n</i> A	Append <i>n</i> lines.
	[ <i>ln1</i> ] [, <i>ln2</i> ]D	Delete line(s).
	<i>ln</i>	Edit line <i>n</i> .
	E	Exit EDLIN.
	<i>ln1</i>	Insert line <i>ln</i> .
	[ <i>ln1</i> ] [, <i>ln2</i> ]L	List line(s).
	Q	Quit EDLIN.
	[ <i>ln1</i> ] [, <i>ln2</i> ] [?]R[ <i>string1</i> ]F6[ <i>string2</i> ]	Search and replace text.
	[ <i>ln1</i> ] [, <i>ln2</i> ] [?]S[ <i>string</i> ]	Search text.
	[ <i>n</i> ]W	Write <i>n</i> lines.
Editing:	F1 or →	Copy one character.
	F2 <i>n</i>	Copy <i>n</i> characters.
	F3	Copy all characters.
	DEL	Skip one character.
	F4 <i>n</i>	Skip <i>n</i> characters.
	ESC	Skips current line.
	INS	Enter or exit insert mode (toggle).
	F5	Create new template.

EXIT

Internal command. Exit COMMAND.COM.

FC *filespec1 filespec2*[/*switch*]

External utility. Compare the data of two files.

Switches:	/B	Binary compare.
	/c	Ignore upper- and lowercase differences.
	/w	Compress tabs and spaces during compare.

FIND "*string*" [*filespec...*]/[*switch*]

External utility. Search for string in specified file(s).

Switches:	/c	Count matches.
	/I	Ignore upper- and lowercase differences.
	/N	Number of lines before find to display.
	/v	Display lines that do not contain string.

## Appendix B

**FOR %variable IN set DO command**

Internal command. Branch command for batch processor.

**FORMAT [d:] [/switch]**

External utility. Format a disk to receive MS-DOS files (9 sectors/track).

Switches:

/C	Clear directory only; do not format.
/M	Single-sided format only.
/N	Suppress operator prompts.
/S	Include system files; make disk bootable.
/V	Verify; read after write; lock out bad sectors.
/8	Format 8 sectors/track.

**GOTO label**

Internal command. Jump command for batch processor.

**IF [NOT] condition command**

Internal command. Conditional branch for batch processor.

**LIB [command,] [listing] [@filename]**

External utility. MS-DOS macro library manager.

Commands:

+	Append object file to library.
-	Delete module from library.
*	Extract a module; place in object file.
;	Use defaults to remaining prompts.
&	Extend current logical line; repeat prompt.
CTRL-BREAK	Exit library session.

**LINK [Objfile,Runfile,Listfile,Liblist[/switch]] [@filespec]**

External utility. MS-DOS linking loader.

Switches:

/DSALLOCATE	Load data at high end of data segment.
/HIGH	Place runfile in high memory.
/LINENUMBER	Include line numbers in list file.
/MAP	List global symbols and definitions.
/PAUSE	Halt session; press RETURN to continue.
/STACK: n	Set stack size to n.

Commands:

+	Separate entries/extend current logical line.
;	Use defaults to remaining prompts.
CTRL-BREAK	Exit linker session.

**MKDIR** [*d:*] *path*

**MD** [*d:*] *path*

Internal command. Create new directory path and directory.

**MORE** <*filespec*

*command filespec* | **MORE**

External utility. Display contents of file or result of command one screen at a time.

**PATH** [*d:*] [*path*]; [*d:*] *path*...]

Internal command. Specify path name(s) to be used by external commands.

**PAUSE** [*comment*]

Internal command. Temporarily suspend execution of batch file. *Comment* can be any text material.

**PRINT** [*filespec* [/switch] [*filespec* [/switch]...]]

External utility. Print the contents of an ASCII file on a printer.

Switches:

/A	Do not print file(s) from /A to /S switches.
/C <i>n</i>	Print <i>n</i> copies.
/F	Issue form feed (top of page) at end of file.
/L <i>n</i>	Set left margin at <i>n</i> .
/P <i>n</i>	Set page length to <i>n</i> lines.
/R <i>n</i>	Set right margin at <i>n</i> .
/S	Add file(s) to print queue from /S to /A switches.
/T	Terminate printing; empty print queue.

**PROMPT** [*comment*]

Internal command. Change the MS-DOS prompt and/or material.

Comments:

\$	Specifies parameter or delimiter to follow.
t	Current time.
d	Current date.
p	Current directory path name.
v	Current MS-DOS version number.
n	Designate default drive.
g	Specify > character.
l	Specify < character.
b	Specify   character.
—	New line.
s	Leading space.
h	Backspace.
e	Escape code (01BH).

Appendix B

---

**PSC***name*

External utility. Load printer driver into memory to allow graphics print screen dumps using CTRL-PRTS.

Names:	IDS	IDS prism printers.
	MPI	MPI printers.
	MX80	Epson printers with Graftrax <sup>™</sup> .
	OKI	Okidata printers.
	P920	Printek 920 printer.
	TS315	TranStar 315 color printer.

**RDCPM** [?][DIR *d*: [*filespec*][/*switch*]][[*d*:]*filespec1* [*d*:]*filespec2*][/*switch*]]

External utility. Copy file(s) from CP/M formatted disk.

Switch:	/z	Read Zenith Data Systems CP/M formatted disk.
---------	----	---

**RECOVER** [*d*:]*filespec*

External utility. Recover file(s) specified on damaged disks.

**REM** [*comment*]

[. [*comment*]]

Internal command. Displays a comment in a batch file.

**REN** *filespec1 filespec2*

**RENAME** *filespec1 filespec2*

Internal command. Rename first file as second file.

**RESTORE** [?][[*d*:]*filename* [*filespec*{+*filespec*...}][/*switch*]]

External utility. Restores one or more files from single backup file.

Switches:	/A[: <i>date</i> ]	Restore files after <i>date</i> .
	/B[: <i>date</i> ]	Restore files before <i>date</i> .
	/D	Provide directory of master backup files.
	/E	Restore all but exception files.
	/F	Restore all files.
	/L	List internal backup file directory.
	/M: <i>d</i>	Restore files to drive <i>d</i> .
	/O	Overwrite existing file(s) with same name.
	/Q	Query each file before restoring.
	/R	List files to be restored.
	/T	Restore files with today's date only.
	/V	Verify; read after write.



**RMDIR** [*d:*]*path*

**RD** [*d:*]*path*

Internal command. Remove a directory path (must be empty).

**SEARCH** [*filespec*] [/switch]

External utility. Locate file(s) on a disk and list directory structure.

Switches:	/C	Do not search subdirectories.
	/D	List names of directories being searched.
	/T	Display directory structure.

**SET** [*string*=*string*]

Internal command. Set, change, or clear value in system environment.

**SHIFT**

Internal command. Shift batch parameters one position.

**SORT** [/switch] [<][*filespec*] [>][*filespec*]

*command* | **SORT** [/switch]

External utility. Sorts material specified in ascending order.

Switches:	/R	Sort in descending order.
	/+ <i>n</i>	Sort material, based on column <i>n</i> .

**SYS** *d:*

External utility. Transfer the MS-DOS system to designated drive.

**TIME** [*h*[:*m*[:*s*[:*c*]]]

Internal command. Display and/or change time.

**TYPE** [*d:*] [*path*]*filename*

Internal command. Display contents of specified file.

**VER**

Internal command. Display current version number of system files.

**VERIFY** [ON] [OFF]

Internal command. Turn on or off verify feature (read after write).

**VOL** [*d:*]

Internal command. Display disk label in default or designated drive.

## Appendix B

---

### ASCII Codes

The following table is a decimal (DEC) to hexadecimal (HEX) code conversion table of the ASCII codes your computer can generate. The KEY column represents the key you would press to obtain the code illustrated. The CHAR column represents the accepted acronym or letter in the ASCII standard. Since you cannot obtain many of the first thirty-one codes by pressing a single key, the control key combination is shown in the CTRL column. A brief description is given for each code.

#### ASCII Code Conversion

DEC	HEX	CHAR	KEY	CTRL	DESCRIPTION
0	00	NUL	...	@	Null, tape feed.
1	01	SOH	...	A	Start of heading.
2	02	STX	...	B	Start of text.
3	03	ETX	...	C	End of text.
4	04	EOT	...	D	End of transmission.
5	05	ENQ	...	E	Enquiry.
6	06	ACK	...	F	Acknowledge.
7	07	BEL	...	G	Rings bell.
8	08	BS	BACK SPACE	H	Back space.
9	09	HT	TAB	I	Horizontal tab.
10	0A	LF	LINE FEED	J	Line feed: advance cursor to next line.
11	0B	VT	...	K	Vertical tab (VTAB).
12	0C	FF	...	L	Form feed to top of next page.
13	0D	CR	RETURN	M	Carriage return to beginning of line.
14	0E	SO	...	N	Shift out.
15	0F	SI	...	O	Shift in.
16	10	DLE	...	P	Data link escape.
17	11	DC1	...	Q	Device control 1: turns transmitter on (XON).
18	12	DC2	...	R	Device control 2.
19	13	DC3	...	S	Device control 3: turns transmitter off (XOFF).
20	14	DC4	...	T	Device control 4.
21	15	NAK	...	U	Negative acknowledge: also ERR (error).
22	16	SYN	...	V	Synchronous idle (SYNC).

## ASCII Code Conversion (continued)

DEC	HEX	CHAR	KEY	CTRL	DESCRIPTION
23	17	ETB	...	W	End of transmission block.
24	18	CAN	...	X	Cancel (CANCL). Cancels current escape sequence.
25	19	EM	...	Y	End of medium.
26	1A	SUB	...	Z	Substitute.
27	1B	ESC	ESC	[	Escape.
28	1C	FS	...	\	File separator.
29	1D	GS	...	]	Group separator.
30	1E	RS	...	^	Record separator.
31	1F	US	...	-	Unit separator.
32	20	SP	...		Space (spacebar).
33	21	!	!	...	Exclamation point.
34	22	"	"	...	Quotation mark.
35	23	#	#	...	Number sign.
36	24	\$	\$	...	Dollar sign.
37	25	%	%	...	Percent sign.
38	26	&	&	...	Ampersand.
39	27	'	'	...	Acute accent or apostrophe.
40	28	(	(	...	Open parenthesis.
41	29	)	)	...	Close parenthesis.
42	2A	*	*	...	Asterisk.
43	2B	+	+	...	Plus sign.
44	2C	,	,	...	Comma.
45	2D	-	-	...	Hyphen or minus sign.
46	2E	.	.	...	Period.
47	2F	/	/	...	Slash.
48	30	0	0	...	Number 0.
49	31	1	1	...	Number 1.
50	32	2	2	...	Number 2.
51	33	3	3	...	Number 3.
52	34	4	4	...	Number 4.
53	35	5	5	...	Number 5.
54	36	6	6	...	Number 6.
55	37	7	7	...	Number 7.
56	38	8	8	...	Number 8.
57	39	9	9	...	Number 9.
58	3A	:	:	...	Colon.
59	3B	;	;	...	Semicolon.
60	3C	<	<	...	Less than.
61	3D	=	=	...	Equal sign.
62	3E	>	>	...	Greater than.
63	3F	?	?	...	Question mark.

## Appendix B

## ASCII Code Conversion (continued)

DEC	HEX	CHAR	KEY	CTRL	DESCRIPTION
64	40	@	@	...	At sign.
65	41	A	A	...	Letter A.
66	42	B	B	...	Letter B.
67	43	C	C	...	Letter C.
68	44	D	D	...	Letter D.
69	45	E	E	...	Letter E.
70	46	F	F	...	Letter F.
71	47	G	G	...	Letter G.
72	48	H	H	...	Letter H.
73	49	I	I	...	Letter I.
74	4A	J	J	...	Letter J.
75	4B	K	K	...	Letter K.
76	4C	L	L	...	Letter L.
77	4D	M	M	...	Letter M.
78	4E	N	N	...	Letter N.
79	4F	O	O	...	Letter O.
80	50	P	P	...	Letter P.
81	51	Q	Q	...	Letter Q.
82	52	R	R	...	Letter R.
83	53	S	S	...	Letter S.
84	54	T	T	...	Letter T.
85	55	U	U	...	Letter U.
86	56	V	V	...	Letter V.
87	57	W	W	...	Letter W.
88	58	X	X	...	Letter X.
89	59	Y	Y	...	Letter Y.
90	5A	Z	Z	...	Letter Z.
91	5B	[	[	...	Open brackets.
92	5C	\	\	...	Reverse slash.
93	5D	]	]	...	Close brackets.
94	5E	^	^	...	Caret.
95	5F	_	_	...	Underscore.
96	60	`	`	...	Grave accent.
97	61	a	a	...	Letter a.
98	62	b	b	...	Letter b.
99	63	c	c	...	Letter c.
100	64	d	d	...	Letter d.
101	65	e	e	...	Letter e.
102	66	f	f	...	Letter f.
103	67	g	g	...	Letter g.
104	68	h	h	...	Letter h.
105	69	i	i	...	Letter i.

---

**ASCII Code Conversion (continued)**

---

DEC	HEX	CHAR	KEY	CTRL	DESCRIPTION
106	6A	j	j	...	Letter j.
107	6B	k	k	...	Letter k.
108	6C	l	l	...	Letter l.
109	6D	m	m	...	Letter m.
110	6E	n	n	...	Letter n.
111	6F	o	o	...	Letter o.
112	70	p	p	...	Letter p.
113	71	q	q	...	Letter q.
114	72	r	r	...	Letter r.
115	73	s	s	...	Letter s.
116	74	t	t	...	Letter t.
117	75	u	u	...	Letter u.
118	76	v	v	...	Letter v.
119	77	w	w	...	Letter w.
120	78	x	x	...	Letter x.
121	79	y	y	...	Letter y.
122	7A	z	z	...	Letter z.
123	7B	{	{	...	Left brace.
124	7C			...	Vertical bar (broken).
125	7D	}	}	...	Right brace.
126	7E	~	~	...	Tilde.
127	7F	DEL	DELETE	...	Delete (rub out).
128	80				
129	81				
130	82				
131	83				
132	84				
133	85				
134	86				
135	87				
136	88				
137	89				
138	8A				
139	8B				
140	8C				
141	8D				
142	8E				
143	8F				
144	90				
145	91				
146	92				

Appendix B

---

ASCII Code Conversion (continued)

---

DEC	HEX	CHAR	KEY	CTRL	DESCRIPTION
147	93				
148	94				
149	95				
150	96				
151	97				
152	98				
153	99				
154	9A				
155	9B				
156	9C				
157	9D				
158	9E				
159	9F				
160	A0				
161	A1				
162	A2				
163	A3				
164	A4				
165	A5				
166	A6				
167	A7				
168	A8				
169	A9				
170	AA				
171	AB				
172	AC				
173	AD				
174	AE				
175	AF				
176	B0				
177	B1				
178	B2				
179	B3				
180	B4				
181	B5				
182	B6				
183	B7				
184	B8				
185	B9				
186	BA				
187	BB				

---

**ASCII Code Conversion (continued)**

---

DEC	HEX	CHAR	KEY	CTRL	DESCRIPTION
188	BC				
189	BD				
190	BE				
191	BF				
192	C0				
193	C1				
194	C2				
195	C3				
196	C4				
197	C5				
198	C6				
199	C7				
200	C8				
201	C9				
202	CA				
203	CB				
204	CC				
205	CD				
206	CE				
207	CF				
208	D0				
209	D1				
210	D2				
211	D3				
212	D4				
213	D5				
214	D6				
215	D7				
216	D8				
217	D9				
218	DA				
219	DB				
220	DC				
221	DD				
222	DE				
223	DF				
224	E0				
225	E1				
226	E2				
227	E3				
228	E4				

Appendix B

---

ASCII Code Conversion (continued)

---

DEC	HEX	CHAR	KEY	CTRL	DESCRIPTION
229	E5				
230	E6				
231	E7				
232	E8				
233	E9				
234	EA				
235	EB				
236	EC				
237	ED				
238	EE				
239	EF				
240	F0				
241	F1				
242	F2				
243	F3				
244	F4				
245	F5				
246	F6				
247	F7				
248	F8				
249	F9				
250	FA				
251	FB				
252	FC				
253	FD				
254	FE				

---



## Z-170 PC Keyboard Codes

The following table illustrates codes returned by Z-100 PC Series computer hardware. Operating systems and program languages (such as MS-DOS and GW-BASIC) will not receive the same information; the hardware codes will be intercepted and converted.

For most keys, the value received will be the least significant byte of the key code. For instance, 2C7AH would be received as 7AH.

However, keys where the least significant byte is 0, will generate two bytes, the first having a value of zero (0) to indicate a special key and the second being the code of the key itself. Thus, function key F10 (which generates 7100H in hardware) will generate 00H followed by 71H.

### Keyboard Codes, Hardware Generated

KEY	NOT				
	SHIFTED	SHIFTED	CONTROL	ALT	CAPS LOCK
ESC	011BH	011BH	011BH	----	011BH
1/!	0231H	0221H	----	7800H	0231H
2/@	0332H	0340H	0300H	7900H	0332H
3/#	0433H	0423H	----	7A00H	0433H
4/\$	0534H	0524H	----	7B00H	0534H
5/%	0635H	0625H	----	7C00H	0635H
6/↑	0736H	075EH	071EH	7D00H	0736H
7/&	0837H	0826H	----	7E00H	0837H
8/*	0938H	092AH	----	7F00H	0938H
9/(	0A39H	0A28H	----	8000H	0A39H
0/)	0B30H	0B29H	----	8100H	0B30H
-/_	0C2DH	0C5FH	0C1FH	8200H	0C2DH
=/+	0D3DH	0D2BH	----	8300H	0D3DH
BACK SPACE	0E08H	0E08H	0E7FH	----	0E08H
TAB	0F09H	0F00H	----	----	0F09H
Q	1071H	1051H	1011H	1000H	1051H
W	1177H	1157H	1117H	1100H	1157H
E	1265H	1245H	1205H	1200H	1245H
R	1372H	1352H	1312H	1300H	1352H
T	1474H	1454H	1414H	1400H	1454H
Y	1579H	1559H	1519H	1500H	1559H

## Appendix B

## Keyboard Codes, Hardware Generated (continued)

KEY	NOT SHIFTED	SHIFTED	CONTROL	ALT	CAPS LOCK
U	1675H	1655H	1615H	1600H	1655H
I	1769H	1749H	1709H	1700H	1749H
O	186FH	184FH	180FH	1800H	184FH
P	1970H	1950H	1910H	1900H	1950H
[{/	1A5BH	1A7BH	1A1BH	----	1A5BH
]/	1B5DH	1B7DH	1B1DH	----	1B5DH
RETURN	1C0DH	1C0DH	1C0AH	----	1C0DH
CTRL	----	----	----	----	----
A	1E61H	1E41H	1E01H	1E00H	1E41H
S	1F73H	1F53H	1F13H	1F00H	1F53H
D	2064H	2044H	2004H	2000H	2044H
F	2166H	2146H	2106H	2100H	2146H
G	2267H	2247H	2207H	2200H	2247H
H	2368H	2348H	2308H	2300H	2348H
J	246AH	244AH	240AH	2400H	244AH
K	256BH	254BH	250BH	2500H	254BH
L	266CH	264CH	260CH	2600H	264CH
;/:	273BH	273AH	----	----	273BH
"/'	2827H	2822H	----	----	2827H
`/~	2960H	297EH	----	----	2960H
(Left) SHIFT	----	----	----	----	----
\ /	2B5CH	2B7CH	2B1CH	----	2B5CH
Z	2C7AH	2C5AH	2C1AH	2C00H	2C5AH
X	2D78H	2D58H	2D18H	2D00H	2D58H
C	2E63H	2E43H	2E03H	2E00H	2E43H
V	2F76H	2F56H	2F16H	2F00H	2F56H
B	3062H	3042H	3002H	3000H	3042H
N	316EH	314EH	310EH	3100H	314EH
M	326DH	324DH	320DH	3200H	324DH
,/<	332CH	333CH	----	----	332CH
./>	342EH	343EH	----	----	342EH
//?	352FH	353FH	----	----	352FH
(Right) SHIFT	----	----	----	----	----
*/PRT SC	372AH	(Note 1)	7200H	----	372AH
ALT	----	----	----	----	----
(Space)	3920H	3920H	3920H	3920H	3920H
CAPS LOCK	----	----	----	----	----
F1	3B00H	5400H	5E00H	6800H	3B00H
F2	3C00H	5500H	5F00H	6900H	3C00H
F3	3D00H	5600H	6000H	6A00H	3D00H

---

**Keyboard Codes, Hardware Generated (continued)**

---

KEY	NOT				
	SHIFTED	SHIFTED	CONTROL	ALT	CAPS LOCK
F4	3E00H	5700H	6100H	6B00H	3E00H
F5	3F00H	5800H	6200H	6C00H	3F00H
F6	4000H	5900H	6300H	6D00H	4000H
F7	4100H	5A00H	6400H	6E00H	4100H
F8	4200H	5B00H	6500H	6F00H	4200H
F9	4300H	5C00H	6600H	7000H	4300H
F10	4400H	5D00H	6700H	7100H	4400H
NUM LCK	----	----	(Note 2)	----	----
SCROLL LCK	----	----	(Note 3)	(Note 4)	----

---

KEY	NOT				
	SHIFTED	SHIFTED	CONTROL	ALT	NUM LOCK
HOME / 7	4700H	4737H	7700H	(Note 5)	4737H
(Up) / 8	4800H	4838H	----	(Note 5)	4838H
PGUP / 9	4900H	4939H	8400H	(Note 5)	4939H
-	4A2DH	4A2DH	----	----	4A2DH
(Left) / 4	4B00H	4B34H	7300H	(Note 5)	4B34H
5	----	4C35H	----	(Note 5)	4C35H
(Right) / 6	4D00H	4D36H	7400H	(Note 5)	4D36H
+	4E2BH	4E2BH	----	----	4E2BH
END / 1	4F00H	4F31H	7500H	(Note 5)	4F31H
(DOWN) / 2	5000H	5032H	----	(Note 5)	5032H
PGDN / 3	5100H	5133H	7600H	(Note 5)	5133H
INS / 0	5200H	5230H	----	(Note 5)	5230H
DEL / .	5300H	532EH	----	----	532EH
ENTER	540DH	540DH	540AH	----	540DH

## Appendix B

---

### NOTES:

1. CTRL-PRT SC causes the contents of the screen to be printed.
2. CTRL-NUM LCK causes the running program to pause until another key is pressed.
3. CTRL-BREAK is used to break (abort) a program. This key sequence sends a special key code of 0000H.
4. ALT-BREAK is used to empty the type-ahead buffer.
5. Special keycodes can be entered directly by pressing and holding the ALT key, and then entering the three-digit keycode (in decimal) on the numeric keypad. Releasing the ALT key will then generate the desired keycode. For example, pressing ALT, then entering 1, 2, and 3 on the numeric keypad, then releasing ALT, will generate a keycode of 123 decimal = 7BH. When entering these special keycodes, the high byte of the key code is set to 38H, which is the scan code for the ALT key. Thus, the complete key code for ALT-1-2-3 is 387BH.

## Cross-Reference Chart

Z-100 PC Computer Series	Z-170 Portable Computer
Keystrokes Required	Actual Keys typed
Unshifted/Left Arrow	Left Arrow
Unshifted/Right Arrow	Right Arrow
Unshifted/Up Arrow	Up Arrow
Unshifted/Down Arrow	Down Arrow
Unshifted/Num Lock	Num Lock
Unshifted/Delete	Delete
Unshifted/Home	Right Shift + Home
Unshifted/End	Right Shift + End
Unshifted/Pg Up	Right Shift + Pg Up
Unshifted/Pg Dn	Right Shift + Pg Dn
Unshifted/Scroll Lock	Right Shift + Scroll Lock
Unshifted/Insert	Right Shift + Insert
Shift/Left Arrow	Left Shift + Left Arrow
Shift/Right Arrow	Left Shift + Right Arrow
Shift/Up Arrow	Left Shift + Up Arrow
Shift/Down Arrow	Left Shift + Down Arrow
Shift/Num Lock	Left Shift + Num Lock
Shift/Delete	Left Shift + Delete
Shift/Home	Left Shift + Right Shift + Home
Shift/End	Left Shift + Right Shift + End
Shift/Pg Up	Left Shift + Right Shift + Pg Up
Shift/Pg Dn	Left Shift + Right Shift + Pg Dn
Shift/Scroll Lock	Left Shift + Right Shift + Scroll Lock
Shift/Insert	Left Shift + Right Shift + Insert

## Hayes Auto Dialing Protocol

### Commands

Each command in the Hayes auto dialing protocol follows the same format, as shown below, except for the “A” command which is described later.

`<AT><Command>{Argument} { = n} {More} <CR>`

<code>&lt;&gt;</code>	Indicate that these “fields” must be included as part of the command line.
<code>{ }</code>	Indicate that these “fields” may not be necessary as part of the command line.
AT	Attention code to let the modem know a command will be following. Must be in capital letters.
Command	One or two letter command. Functions of the different commands follows.
Argument	An optional field that further defines the command.
<code>= n</code>	Used when setting a register. These registers may be used to change certain default options.
More	Commands may be strung together in one command line as long as 40 characters. AT (attention code) is only needed at the beginning of the command line.
CR	Carriage return or enter key. Tells the modem to execute the previous command(s).

**NOTE:** In the following commands, “r” and “n” are used as variables; “n...n” means that an item can be repeated as many times as necessary (up to 40 characters).

Command	Function										
A	Immediately answer an incoming call.										
A/	Perform the last command issued again. For instance, can be used to redial a number if the previous command was dialed.										
C	Argument (n) n = 0 or 1 (default = 1) C0 turns the carrier signal off; C1 turns the carrier signal on.										
D	Argument (n...n) n = 0-9, *, #, P, R<, T, ;, , Dials the phone number expressed by the argument. The number will be dialed with either tones or pulses depending on how the last number was dialed. On power-up, this command will default to pulse dialing.										
DP	Argument (n...n) n = 0-9, *, #, P, R<, T, ;, , Dials the phone number using tone dialing. These are the special characters that can be included in a dialing string: <table border="0" data-bbox="298 850 946 1357"> <tr> <td>P</td> <td>Pulse dial the following numbers.</td> </tr> <tr> <td>R</td> <td>Enter answer mode after dialing number. This character should only be at the end of the dialing string.</td> </tr> <tr> <td>T</td> <td>Tone dial the following numbers.</td> </tr> <tr> <td>;</td> <td>Return to command state. You can now enter other commands that are to be executed while online.</td> </tr> <tr> <td>,</td> <td>Insert inside a dialing string for a two-second pause during the dialing sequence. (Pause duration can be changed by S8 register setting—described later.)</td> </tr> </table>	P	Pulse dial the following numbers.	R	Enter answer mode after dialing number. This character should only be at the end of the dialing string.	T	Tone dial the following numbers.	;	Return to command state. You can now enter other commands that are to be executed while online.	,	Insert inside a dialing string for a two-second pause during the dialing sequence. (Pause duration can be changed by S8 register setting—described later.)
P	Pulse dial the following numbers.										
R	Enter answer mode after dialing number. This character should only be at the end of the dialing string.										
T	Tone dial the following numbers.										
;	Return to command state. You can now enter other commands that are to be executed while online.										
,	Insert inside a dialing string for a two-second pause during the dialing sequence. (Pause duration can be changed by S8 register setting—described later.)										
E	Argument (n) n = 0 or 1 (default = 1) Determines if characters are echoed in the command state. E0 is off; E1 is on.										

## Appendix B

---

### Command Function

- F**            Argument (n) n = 0 or 1 (default = 1) Similar to previous command, but only active when another modem is connected. Determines if characters are echoed while online. F0 is on, half-duplex; F1 is off, full-duplex.
- H**            Argument (n) n = 0 or 1 (default = 0) H0 means onhook or hang up phone; H1 means offhook or pick up telephone.
- I**            Argument (n) n = 0 or 1 (default = 0) Asks for identification code.
- L**            Argument (n) n = 0 to 7 (default = 4) Controls modem's speaker volume. L0, speaker off; L1, volume level 1; L2, volume level 2; L3, volume level 3; L4, mid-range volume level; L5, volume level 5; L6, volume level 6; L7, maximum volume.
- M**            Argument (n) n = 0, 1, or 2 (default = 1) Controls modem speaker function. M0, speaker off; M1, speaker on until carrier is detected; M2, speaker on all of the time.
- O**            Causes modem to go offhook in the same mode, originate or answer, that was being used on previous call.
- Q**            Argument (n) n = 0 or 1 (default = 0) Q0, send result codes; Q1, stay quiet.
- S**            Argument (r?) r = 0 to 12, 16  
 Lets you read the value of any 14 registers stored in the modem. These registers are used to set up operating parameters. See the register summary which follows for registers and possible values and functions.
- Argument (r=n) r = 0 to 12, 16 n = 0 to 255 Allows you to modify the value of any of 14 registers.
- V**            Argument (n) n = 0 or 1 (default = 1) V0 sends result codes as digits, V1 sends result codes as words.
- Z**            Resets all commands and registers to default settings.



## Registers

### Dialing

REGISTER	RANGE	UNITS	FUNCTION	DEFAULT
S6	2-255	seconds	Wait time for dial tone	2
S8	0-255	seconds	Length of pause caused by comma	2
S11	50-255	milli-seconds	Duration and spacing of touch tones	70

### Answering

S0	0-255	rings	Number of rings on which modem answers call	0
S1	0-255	rings	Number of rings occurred	0

### Dialing and Answering

S7	1-255	seconds	Wait time for carrier	30
S9	1-255	1/10 sec	Carrier detect response time	6

### Character Definitions

S2	0-127	ASCII	Escape code character	43
S3	0-127	ASCII	Carriage return character	13
S4	0-127	ASCII	Line feed character	10
S5	0-32, 127	ASCII	Backspace character	8

### Special Functions

S12	0-255	1/50 sec	Escape code guard time	50
S16	0-2		Self test	0



# INDEX

- #1 and #2 keys (Directory Display), A.13, A.17
- #1 and #2 keys (Update Display), A.14, A.16, A.17
- 256K Dynamic RAM Chips installation, A.6
- 300/1200 Baud Modem
  - installation, A.8
  - operation, A.11
- A> prompt, 18, 25
- AC adapter, 11, 62, A.4
  - connector, 10
  - requirements, 10, 11, 64,
- ADD function key (phone), A.17, A.19, A.22
- Addition example, 36, 37
- Alarm, 50
- Alphanumeric keys, 26
- ALT key, 27
  - resetting with, 57, 62
  - transferring Memory Value to program, 35
- Alternate key, see ALT key
- Appointment Calendar, 49
  - activating and leaving, 49, 51
  - function keys, 50, 51
  - memory usage, 49
  - selecting a day, month, 49, 50
- Appointments
  - adding and erasing, 49, 50
  - typing, 50
- AREA CODE key (Directory Display), A.12
- Area codes (Update Display), A.16, A.21
  - entering, A.16
  - dialing from keyboard, A.13
  - parentheses with, A.16, A.17
- Arrow keys, 28, A.15
  - with Appointment calendar, 50
  - with Directory Display, A.11, A.17
  - with Shift key, 28
- ASCII Codes, B.12
- Automatic boot disks, 45, 60
- Autorepeat, 22
- B> prompt, 25
  - see also A> prompt
- Backing up
  - valuable disks, 19
  - see also COPY and DISKCOPY
- Backlighting, screen, 6, 10
- Battery Low message, 62, A.4

# Index

---

- Battery pack, A.3
  - charging, A.4
  - compartment, 10, A.3
  - installing, A.3
  - run down, A.4
- Baud rate
  - internal modem, 48
  - standalone modem, see serial port
  - serial port, 46
  - serial printer, 46
- Black and white composite video,
  - see Monitors and Video Graphics Adapter
- Boot disks,
  - automatic 15, 17
- Booting,
  - first time, 16
  - general procedure, 16
  - Start-Up Action (Setup Menu), 45
- BREAK KEY, 31
- Bulletin Board services, A.11, A.22
- Bytes Free Message, 49, A.13
  
- Cables, see also connectors
  - null modem, 56
  - parallel printers, 8, 56
  - serial printers 8, 56
- Calculator Icon, 24
  - transferring Memory Value, 35
- Calculator, 32
  - activating and leaving, 32
  - display symbols, 35
  - examples, 36
  - keys, 32
  - moving the display window, 24
- Calendar display, see World Map Display
- Calendar Icon, see Clock Icon
- Calendar
  - setting, 43
  - see also Appointment calendar
- Call timer, see Timer
- Capital letters, see Upper and lower
- CAPS LOCK key, 26, 27
- Care of computer, 3
- Care of disks, 13, 14
- Caret ( ^ ) symbol, 27
- Case, see Upper and lower
- Centronics, 8
- Centronics printer, see Printers, parallel
- Change sign key (Calculator), 33
- Clear entry key (Calculator), 33

- Clock/calendar display, 40
  - see also World Map Display
- Clock, setting time, 43
- Clock Icon, 23, 32
- Closing the computer, 4
- Color monitor, see RGB and Monitors
- Commands
  - aborting (Break), 31
  - entering, 26
  - see also Programs
- Composite video monitors,
  - see also Monitors and Video Graphics Adapter
- Computer care, 3
- Connecting the computer to phone system, A.9
- Connectors,
  - AC adapter, 10
  - composite video, 53
  - expansion bus, 9, 54
  - parallel, 2, 5, 8, 54
  - Pinouts, 54, 55
  - RGB, 9, 53
  - serial, 8, 52, 54
  - telephone/modem, 8, 52, A.9, A.10
- Control (CTRL) key, see CTRL
- CPU specifications, 63
- CPU test, 60
- Cross-Reference Chart (Z-100/Z-170), 21, B.23
- CTRL (Control) key, 27
  - resetting with, 29, 57, 62
- Cursor, 6
  - Directory and Update displays, A.12, A.15
- Cursor keys, 28
  - see also Arrow keys,
  
- Data bits
  - internal modem, 48, A.21
  - serial port, 46
- Data disks, 15
- Data, saving on disk, A.18
- Date, setting, 43
- DAY function keys (Appointment Calendar),
- DAY function keys (World Map Display), 40
- Decimal point key (Calculator), 33
  
- DEL key, 26
- Delays while dialing, A.16, A.19
- DELETE/INSERT key, 27, 29
  - resetting with, 29, 57, 62
- Device connectors, see Connectors

## Index

---

- Devices (printers, etc.), 3
  - see also Connectors, Setup Menu,
  - and individual device
- DIAL function key (phone), A.13
- Dial, viewing angle, 10
- Dialing phone numbers, A.14
  - delays, A.16, A.19
  - from keyboard (example), A.22
  - from keyboard (details), A.17
  - tone and pulse, A.16, A.18
  - see also Directory Display and Update Display
- Digit keys (Calculator), 33
- Dimensions, 64
- Directory Display (phone), A.12
  - adding names/numbers, A.12, A.14, A.17, A.22
  - changing names/numbers, A.14
  - dialing from, A.14
  - letter keys, A.12
  - moving around in, A.11, A.12
  - removing names/numbers, A.14, A.17
  - selecting a number, A.22
  - special characters, A.16
  - see also Modem, Phone, Update Display
- Disassembly, general, A.1
- Discount example, 38
- Disk Drives,
  - indicator, 7
  - letters, 7
  - opening, 7, 17
  - protection during travel, 3, 7
  - read test, 60
  - seek function test, 60
- Disks,
  - Automatic boot, 45, 60
  - boot disks, 17
  - care of, 13, 14
  - copy protection, 13
  - checking available space, 20
  - copying masters, 19
  - data, 15
  - directories, 20
  - formatting, 19
  - inserting, 17
  - labelling, 13, 14
  - organization, 15
  - physical features, 13
  - program, 15
  - saving data on, 19
  - space taken by files, 20
  - specifications, 13

- storage capacity, 20
- system, 15
- tests, 60
- type to buy, 7, 13
- write-protecting, 13, 14
- see also Disk drives
- Disk Icon, 23
  - booting with, 23
  - returning to programs, 24
- Display symbols (Calculator), 35
- Display
  - adjusting, 6, 10
  - cursor, 6
  - external monitors, 45
  - lighting (screen saver), 6
  - specifications, 63
  - see also Monitors
- Divide key (Calculator), 33
- Division example, 36, 38
- DOWN KEY, see Arrow keys
- Drives, see Disk drives
- Dynamic RAM (DRAM), 12
  
- END key, 28
- Entering commands, see Commands
- Environmental considerations, 64
- Equal key (Calculator), 33
- Equipment failure, 59
- Error messages, 60
  - Bad disk controller, 61
  - Battery Low, 62, A.4
  - CPU failure, 60
  - CRC error, 61
  - DMA overrun error, 61
  - Drive not ready, 61
  - Invalid address mark detected, 61
  - RAM failure, 60
  - ROM checksum failure, 60
  - Seek failure, 61
  - Sector not found, 61
  - Timer interrupt failure, 61
- EXIT function key (Appointment Calendar), 51
- EXIT function key (Update Display), A.17
- Expansion specifications, 63
  - connector, 9
  - modems, 8
  - monochrome adapters, 9
  - port, 9
  - networks, 1, 8

## Index

---

- External modems,
  - see Modems
- External monitors,
  - see Monitors
- External Mono Adapter (Setup Menu), 45
- External Mono Adapter, 62, A.10
- F-keys, see Function keys
- Files
  - creating with COPY command, 19
  - data, 15
  - naming, 20
  - formatting program, 19
  - space taken on disks, 20
  - system, 15
- Floppy disks, see Disks and Disk drives
- Foreign time, checking, 41
- Format options, 43
- Formatting program, 19
- Freezing the display, see PAUSE key
- Function key block, 22
- Function keys, 25
  - Appointment Calendar, 49
  - Directory Display (phone), A.12
  - Setup Menu, 42
  - Update Display (phone), A.15
  - with SHIFT, CTRL and ALT, 27
  - World Map Display, 40
- Handshaking, serial port, 47
- Hanging up, A.20, A.22
- HANGUP function key (phone), A.14
- Hardware handshaking, 47
- Hayes Auto Dialing Protocol, B.24
  - registers, B.27
  - Hayes compatible, 8
- HERE/NOW key, 41
- HOME key, 28
- Hours, display format, 43
  - see also TIME
- HUG, A.22
- IBM-PC, 6
  - Asynchronous Communications Adapter, 53
  - Color/Graphics Adapter, 9
  - keyboard, 22
  - Monochrome Display Adapter, 9
  - PC-DOS, 15, 53
- ICs, A.6
- Icon block (keys), 22
- Icons, 22, 23
  - see also individual icons



Input/Output terminal, A.14  
Input/Output specifications, 61  
In Case of Difficulty, 59  
Internal Video Card, 9, 53, A.5  
    see also Monitors  
INSERT/DELETE key, 29  
    resetting with, 29, 57, 62  
Insert mode, 27, 29  
Inserting disks, 13, 17  
Initial Start-Up, 15  
Internal Color Video Card Installation, A.5  
Interrupt Control and Timer Circuit test, 60

joysticks, 53  
jumper settings, A.7

Keyboard dialing, A.14, A.22  
Keyboard, 21  
    alphanumeric, 26  
    calculator keys, 32  
    dialing from, A.14  
    microprocessor test, 60  
    modifier keys, 27  
    program keys, 28  
    special keys, 30

KEYBOARD function key (phone), A.14  
Keys, function, see Function keys

Labels, 13  
LCD, 6  
LED, 7  
LEFT key, see Arrow keys  
Letter keys with Directory Display, A.12  
Light, screen, 6, 10  
Lower case, see Upper and lower

M = Modem special letter, A.16  
Master disks, 17  
    copying, 19  
Measurements, 64  
Memory  
    board, A.6  
    space on disks, 20  
    specifications, 63  
    storage capacity, 63  
    types, 12  
Memory Calculations example, 39  
Memory clear key (Calculator), 34  
Memory minus key (Calculator), 34

## Index

---

- Memory plus key (Calculator), 34
- Memory recall key (Calculator), 34
- Memory value (Calculator), 34, 35, 39
  - transferring to a program, 34
- Messages, see Error messages
- Mice, 53
- Minus key (Calculator), 33
- Modem Icon, see Phone Icon
- Modem, Internal, 48
  - Setup Menu options, 48
  - wiring to phone system, A.9
  - see also Modem Program
- Modem, External,
  - see Serial Port
- Modem Program, A.21
  - activating and leaving, A.14, A.15, A.21
  - adding numbers, A.14, A.21, A.22
  - and Setup Menu, 48, A.21
  - calling, A.14, A.22
  - "Hands-On" Experience, A.22
  - hanging up, A.14, A.22
  - tone and pulse dialing, A.16, A.18
  - see also Dialing, Directory Display, and Update Display
- Modifier keys, 22, 27
  - and function keys, 25
- Monitors,
  - black and white (composite), 9
  - color (RGB), 9
  - monochrome, 9
  - Setup Menu options, 45
  - television set, 9
  - see also Display, Monochrome Internal Color Video Card
- MONTH function keys (World Map Display), 40
- Monochrome adapter/monitor, 9
- Moving the cursor, 28
- MR (Calculator) 33, 35, 36
- MS-DOS, 6, 15, 17
  - back-up copy, 19
  - commands, B.4
  - control functions, B.2
  - definition, 15
  - entering date and time, 18
  - role in running programs, 15
  - syntax notation, B.3
- MS-DOS master disk, 15
  - booting from, 15
  - copying, 19
- MS-DOS System disk, 15
- Multiplication example, 36, 37
- Multiply key (Calculator), 33

- MV (Calculator), 35
  - see also Memory Value
- Naming files, 20
- Negative numbers, example, 38
- Networks, 1
- Non-volatile RAM (NVRAM), 12, 49, A.13, A.18
- NUM/SCROLL LOCK key, 27, 29
- Number keys, 32
- Numeric mode, 26, 27, 29
- On/off switch, 10
  - safety considerations, 3, 11
- Opening the computer, 4
- Opening the disk drives, 17
- Operating systems, general description, 15
- Options, A.1
  - battery pack, A.1, A.3
  - Internal Color Video Card, A.1, A.5
  - 300/1200 Baud Modem, A.1, A.8
  - 256K Dynamic RAM Chips, A.1, A.6
- P = Pulse special letter (phone), A.16, A.18
- PAGE UP/DOWN keys, 28
- Parallel connector, 8, 52
  - pinouts, 54
- Parallel I/O spec, 61
- Parallel printers, see Printers
- Parentheses and area codes, A.16, A.19
- Parity
  - internal modem, 47, A.21
  - serial port, 46
- PAUSE command, 27
- PAUSE key, 29
- PBX systems, A.10
- PC-DOS, 15, 53
- Percentage add-on example, 38
- Percentage discount example, 38
- Peripherals, see Devices
- Phone
  - see Dialing, Directory Display, Modem Program, Phone numbers, and Update Display
- Phone Icon, 23
  - while running programs, A.11
- Phone numbers
  - adding, A.14, A.19
  - backing up on disk, A.18
  - changing, A.14
  - correcting, A.17

## Index

---

- deleting, A.14
- memory usage, 12, 49
- Pinouts
  - expansion bus, 55
  - parallel connector, 54
  - serial connector, 54
- Plotter, 52
- Plus key (Calculator), 33
- Plus sign ( + ) special character (phone), A.16, A.19
- Power requirements, 64
- Power switch, see On/Off switch
- Prefix,
  - entering, A.16
  - with keyboard dialing, A.12, A.13
- PREFIX key (Directory Display), A.12, A.13
- PREFIX key (Update Display), A.16, A.19
- PRINT ON key, 30
  - with TYPE command, 30
- PRINT SCREEN key, 30
- Printers, 46
  - baud rate, see Baud rate
  - connectors, 53
  - parallel, 8, 46, 56
  - problems, 57
  - serial, 8, 46, 56
  - Setup Menu considerations, 46
  - testing, 56
  - see also Connectors, Devices, Printing, and Serial Port
- Printing, 30
- Program disks, 15
- Program files, 15
- Program keys, 22, 28
- PROMPT command, 18, 25
- PRT ON key, see PRINT ON
- PRT SCN key, see PRINT SCREEN
- Pulse dialing, A.16
- RAM, 12
  - specifications, 63
  - test, 60
  - see also Memory and NVRAM
- Random access memory, see RAM
- Read-only memory, see ROM
- REDIAL function key (phone), A.14, A.23
- REMOVE function key (phone), A.17
- Repeated addition example, 37
- Repeated division example, 38
- Repeated subtraction example, 37
- Resetting, general procedure, 57
- Restarting, see Resetting

- RETURN key, 26
  - with Appointment Calendar, 50
  - with Directory Display, A.11
- RGB color monitors, 9, 53
  - see also Monitors and Video Graphics Adapter
- RIGHT key, see Arrow keys
- RJ11C (phone) connector, 8, 52
  - see also Connectors and Modem
- ROM, 12
  - test, 60
- RS-232C, 8
  - see also Serial
  
- Saving data, A.4
- SCHEDULE function key (Setup Menu), 40
- Schedule, 40
  - memory usage, 40
  - see also Appointment calendar
  
- Screen
  - adjusting, 6, 10
  - see also Display and Monitors
- Screen Saver, 45
- SCROLL LOCK/NUM key, 27, 29
- Serial connector, 52
  - pinouts, 54
  - see also Devices and Serial Port
- Serial I/O specifications, 63
- Serial port, 8, 46
  - configuring (Setup Menu), 46
  - for external modem, 8
  - for printer, 8, 56
  - pinouts, 54
- Serial printers, see Printers
- Service, 59
- Setting time and date, 43
- SETUP function key, 42
- Setup Menu, 42, A.21
  - activating, 42
  - external modem, 45
  - function keys, 42
  - initial setup, 42
  - internal modem, A.21
  - monochrome adapter/monitor, 45
  - parallel printers, 46
  - Screen Saver, 45
  - serial printers, 46
  - start-up action, 42
  - time/date/time zone, 40

## Index

---

- SHIFT command, 27
- SHIFT key, 27
  - with function keys, 25
- Shoulder strap removal, 5
- Shoulder strap replacement, 5
- Signals, see Pinouts
- SKIP function keys,
- Special keys, 30
- Specifications, 63
- Starting the computer, see Booting and Resetting
- Start-Up Action (Setup Menu), 45
- Stop bits, 47
  - internal modem, 48
  - serial port, 47
- Subtraction example, 36, 37
- Switch, on/off, 10
- System disks, 15
  - see Boot disks
- System files, 15
- System prompt, see A > prompt
  
- T = Tone special letter (modem), A.16, A.18
- TABkey, 27
- Telephone, see Modem Program and Phone
- TERMINAL function key, A.14
- Time zone, 43
  - checking foreign,
  - setting, 41
  - table, 44
- Time
  - checking foreign, 43
  - display format, 41
  - setting, 41
- Timer, A.13, A.14
- TIMER function key (phone), A.13, A.14
- Tone dialing, A.16, A.18
- Transferring results to programs (Calculator), 32
- Transporting the computer, 3, 7
- Troubleshooting, 59
- TV sets, 9
- Typewriter block (keys), 22
  
- UP key, see Arrow keys
- Update Display (phone), A.15
  - changing, A.15
  - elements, A.16
  - entering, A.16
  - function keys, A.16
  - leaving, A.5
  - see also Directory Display, Modem Program, and Phone Numbers

UPDATE function key (phone), A.14

Upper and lower case letters

    CAPS LOCK, 26

    SHIFT, 27, 29

Viewing angle dial, 6, 10

Voice calls, A.11, A.13, A.14

W = Wait special letter (phone), A.16

World Map display, 40, 45

    function keys, 25, 40

Write protection, 13

XON/XOFF handshaking, 47, 57

ZDOS, 15

ZONE function keys, 41

Repair:

6/1/87 ON Keyboard "Q" would not Respond. Took  
Keyboard apart (+ screws on left side - w/ key) took  
key apart - black plastic; wiggled keyboard connection  
"Q" ok.



---

## **IMPORTANT NOTICE**

### **Demonstration Disk Instructions**

A demonstration disk has been provided with your new Zenith Data Systems microcomputer. This disk contains a program that displays text and graphics, illustrating the features and capabilities of your microcomputer.

To run this demonstration program, insert the disk into the default boot drive. The default boot drive is the one closest to the front of the microcomputer.

Power up the computer. The demonstration disk is bootable and contains a file (AUTOEXEC.BAT) that will automatically load the demo program and begin execution. If your Z-170 PC microcomputer is not set to automatically boot a disk, you must press the DISK ICON key to boot the demonstration disk.

Once the program is running, select the desired menu item to view a part of the demo.

Also included on this disk are two programs (RAMBAK.COM and DATETIME.COM) for use with MS-DOS. RAMBAK.COM allows you to back up and restore your telephone directory and appointment calendar. DATETIME.COM will automatically enter the date and time into MS-DOS. See your Owner's Manual for more details.

A:V

B: ~~18~~ \* \* \*

copy

## IMPORTANT NOTICE

Please write in the following note at the bottom of Page A.4 in your Owner's Manual.

6. When using the computer with the optional battery pack, the "Battery Low" message may occur on the video display during initial bootup and drive access. This is a normal operating characteristic.

Thank you

ZENITH DATA SYSTEMS

ZFL-171-42/595-3532  
591-4828

P-O



## IMPORTANT NOTICE

The text on the attached pages replaces the information on pages A.6 and A.7 in Appendix A in your Owners Manual.

Thank you  
Zenith Data Systems

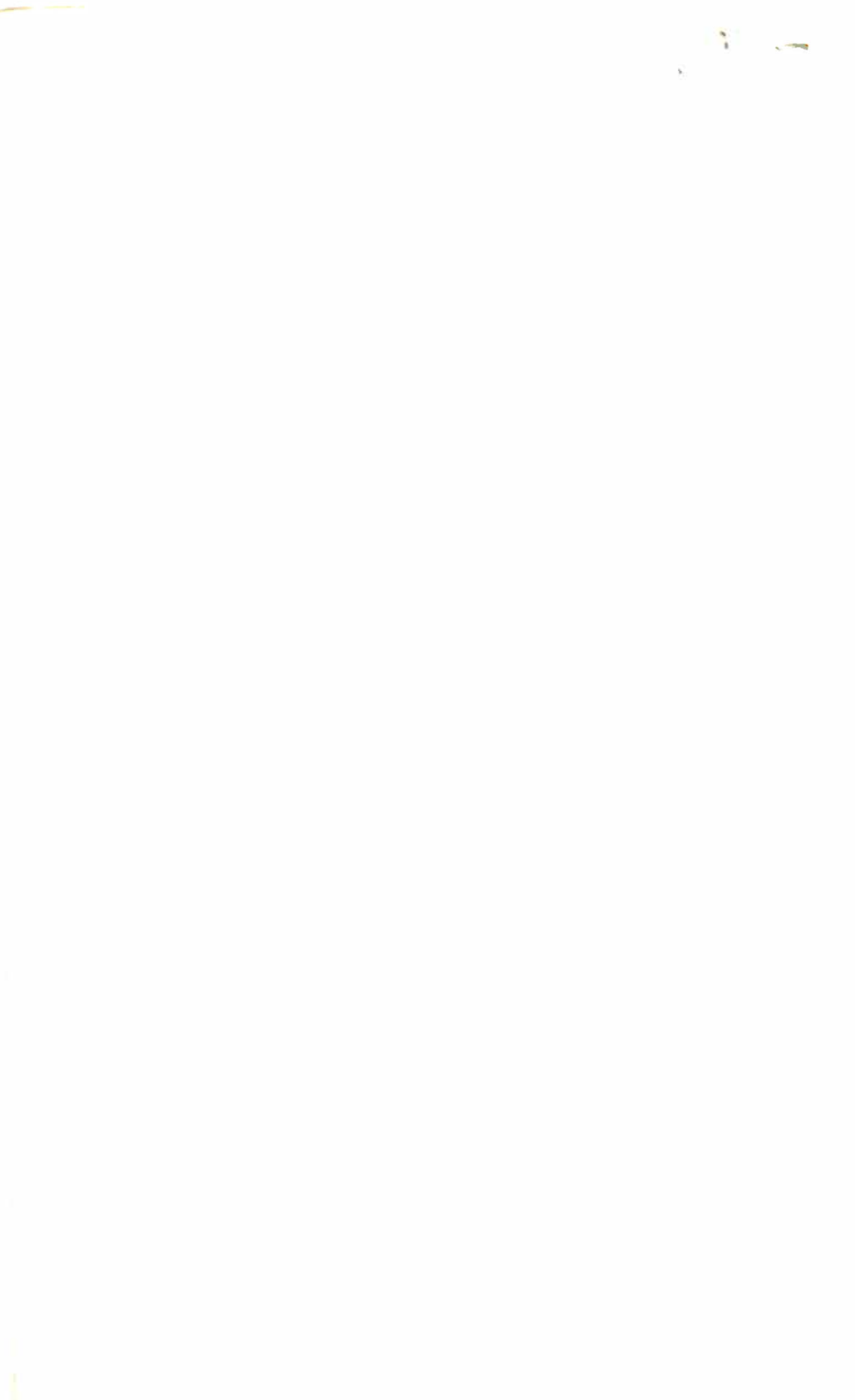

## 256K Dynamic RAM Chips Installation

**CAUTION:** Many integrated circuits (ICs) are electrostatic-sensitive and can be damaged by static electricity. Observe the following precautions when handling ICs.

- Once you remove an IC from its protective foam packing, envelope, or computer, do not lay the IC or board down or let go of it until you install it in your computer.
- It may be necessary to straighten the pins on an IC so they line up with the holes in an IC socket. When you bend the leads of an IC, hold the IC in one hand and place your other hand on your work surface before you touch the IC to the work surface. This equalizes the static electricity between the work surface and the IC. To straighten the pins, lay the IC down on its side and very carefully roll it toward the pins to bend the lower pins into line. Then turn the IC over and bend the pins on the other side.

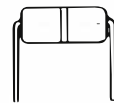

The 256K dynamic RAM chips (Z-205-4) are installed in complete banks (rows of ICs). Install the 256K dynamic RAM chips upgrade in bank D. (Additional upgrades are installed in bank C, then B.)

To install a bank of ICs:

Remove the back cover from the computer. (See "General Disassembly.")

Remove the memory board by gently pulling straight up.

Install eight ICs as shown. (Your package contains 9 ICs. Save one in case you need to replace one in the future.)

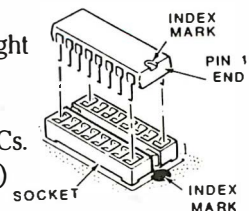

Change the jumper settings for your particular configuration as shown in the following table. Then reinstall the memory board and back cover.



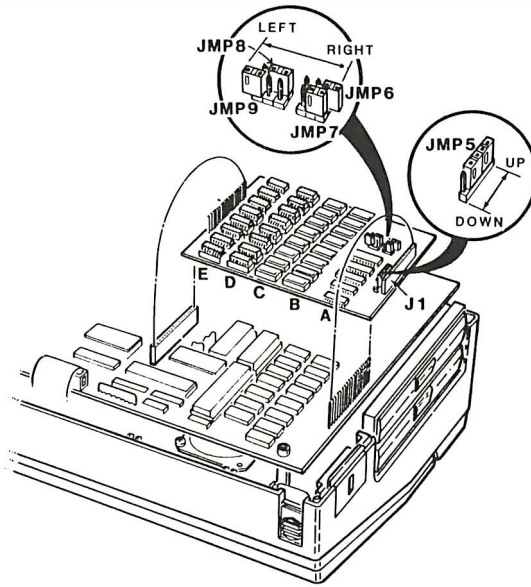

**KEY:**

LEFT: JUMPER INSTALLED ON LEFT TWO PINS.

RIGHT: JUMPER INSTALLED ON RIGHT TWO PINS.

UP: JUMPERS INSTALLED ON TOP FOUR PINS.

DOWN: JUMPERS INSTALLED ON BOTTOM FOUR PINS.

OPEN: NO JUMPER INSTALLED; OR JUMPER ON ONE PIN ONLY.

**POSSIBLE CONFIGURATIONS**

CHIP SIZE IN FOLLOWING BANKS				KILOBYTES OF MEMORY	JUMPER SETTINGS				
E	D	C	B		JMP 5	JMP 6	JMP 7	JMP 8	JMP 9
64	—	—	—	64	Up	Open	Open	Left	Open
64	64	—	—	128	Up	Open	Left	Left	Open
64	64	64	—	192	Up	Open	Left	Left	Left
64	64	64	64	256	Up	Left	Left	Left	Left
256	—	—	—	256	Up or Down	Open	Open	Right	Open
256	—	64	—	320	Down	Open	Open	Right	Right
256	—	64	64	384	Down	Right	Open	Right	Right
256	64	64	64	448	Down	Right	Right	Right	Right
256	256	—	—	512	Up	Open	Right	Right	Open
256	256	64	—	576	Up	Open	Right	Right	Right
256	256	64	64	640	Up	Right	Right	Right	Right

Note: It is also possible to install 64K chips to upgrade the memory; however, only one type of chips may be installed in a bank, either 64K or 256K.



